

SBI PO Main 2019 Memory Based Paper



Direction (1 – 3) : A number arrangement machine when given an input line of numbers rearranges them following a particular rule in each step. The following is an illustration of input and rearrangement.

Input: 734269 825497 647538 219354
961357 321658

Step I: 962437 794528 465783 123945
753169 236185

Step II: 123945 236185 465783 753169
794528 962437

Step III: 135924 135268 357468 135796
579248 379246

Step IV: 3458 31048 152848 33554
351832 211824

Step V: 20 16 28 20 22 18

Step V is the last step of the rearrangement. As per the rules followed in the above steps, find out in each of the following questions the appropriate steps for the given input.

Input: 856347 745982 329584 512379
954267 463512

1. If 20 is related to 28 in step V and 973215 is related to 743658 in step II. In the same way, in step III, 579248 is related to ____.

- A. 135246
- B. 357468
- C. 579246
- D. 359248
- E. None of the above

2. What is the difference between the second element from the left end in step II and second element from the right end in step IV?

- A. 156723
- B. 118964
- C. 127704
- D. 138567
- E. 102488

3. Which element is third to the right of second element from the left end in Step IV?

- A. 33518
- B. 31024
- C. 351832
- D. 351824
- E. 151832

Direction (4 – 6) : Study the following data carefully and answer the questions accordingly.

7 People A, C, F, J, N, R and V, all related to V in some way are facing North. J sits 3rd from the extreme end. V's father sits second to the right of J. Only 3 people are there between V's father and V's sister. As many people sit to the left of V's sister as to the right of V's mother. Only one person sits between N and V's mother. N is the son of C. A sits third to the right of C. C is the father of R. F sits to the immediate right of R. V's wife sits second to the left of V.

4. How many people sit to the right of V?

- A. One
- B. Two
- C. Three
- D. Four
- E. Five

5. Who sits second to the left of V?

- A. C
- B. R
- C. A
- D. J
- E. N

6. How is N related to A?

- A. Father
- B. Father in law
- C. Mother
- D. Sister
- E. Can't be determined

Direction: Study the following data carefully and answer the questions accordingly.

7. A & B → A is 15 m to the north of B
A @ B → A is 23 m to the east of B
A # B → A is 20 m to the south of B
A % B → A is 12 m to the west of B
If P % Q # R & S @ T # U, V @ U, then what is the distance between V and Q?

- A. 20 m
- B. 25 m
- C. 30 m
- D. 15 m
- E. 35 m

Direction (8 – 10) : Study the following data carefully and answer the questions accordingly.

The following words are coded in this manner:

'Words make sentences meaningful' is coded as 8 \$ A, 2!R, 6#C, 14 \$ F

'Rain stops every week' is coded as 2^E, 2#O, 8+A, 8!E

'Eagerly receives ___(a)___' is coded as 12%R, 4^R, 12+V

'Rarely prepares tasty food' is coded as 12%R, 2~S, ___(b)___, 8 @ O

8. What is the code for 'every motivated'?

- A. 5#F 6 @ R
- B. 2^E 6 \$ T
- C. 6#F 8 \$ D
- D. 5 \$ F 7 @ E
- E. 7 @ R 5%R

9. What will come in the blank '(a)'?

- A. Prepares
- B. Rarely
- C. Tasty
- D. Food
- E. Eagerly

10. What will come in the blank '(b)'?

- A. 5 \$ F
- B. 8*D
- C. 10+E
- D. 7#D
- E. 9^Y

Direction (11 – 12) : Study the following data carefully and answer the questions accordingly.

The following codes are used:

clubs (♣), diamonds (♦), hearts (♥) and spades (♠)

A♥B means A is to the North of B.

A♣B means A is to the South of B.

A♠B means A is to the East of B.

A♦B means A is to the West of B.

There are 3 buses travelling from Z to Y.

Bus 1: K 16♦ Z, J 10♣ K, M 9♦ J, D 18♥ M, C 29♠ D, P 9♥ C, Y 4♦ P

Bus 2: E 35♣ Z, F 6♦ E, G 13♥ F, H 19♦ G, K 39♥ H, Y 25♠ L

Bus 3: N 32♠ Z, Q 4♥ N, S 8♦ Q, T 4♥ S, C 20♦ T

11. What is the distance between D & T?

- A. 57 m
- B. 65 m
- C. 45 m
- D. 49 m
- E. None of these

12. What is the direction of H with respect to M?

- A. South
- B. North
- C. South-East
- D. South-West
- E. Can't be determined

Direction (13 – 15) : Study the following data carefully and answer the questions accordingly.

There are 8 people standing in 2 concentric square grounds. Four of them are standing in the outer ground facing inwards and four of them are standing in the inner ground facing outwards. All are standing in the middle of the side of the square. There are 4 couples.

Q is to the immediate right of T. Q faces V. There is only one person between V and R's husband. W faces the immediate neighbour of R. W is not the spouse of T. P neither faces W nor R. S is the immediate neighbour of P. P faces the center.

13. Who is the spouse of U?

- A. W
- B. V
- C. S
- D. P
- E. Can't be determined

14. Who among the following are the immediate neighbours?

- A. QR
- B. PW
- C. VW
- D. SV
- E. None of these

15. Who sits second to the right of T?

- A. U
- B. R
- C. Q
- D. V

E. W

Direction: In the question below is given a statement followed by three assumptions numbered I, II and III. An assumption is something supposed or taken for granted. You have to consider the following assumption and decide which of the assumption is implicit in the statement.

16. Statement: Prime Minister Narendra Modi on February 24 will launch the Rs 75,000-crore Pradhan Mantri Kisan Samman Nidhi (PM-KISAN) scheme in Gorakhpur, Uttar Pradesh, by transferring the first of the three installments of Rs 2,000 each to over one crore farmers having cultivable land up to two hectares. Another one crore farmers will be covered in the next 2-3 days.

Assumptions:

I. The central government had announced the PM-KISAN scheme under which Rs 6,000 per year will be given in three installments to small and marginal farmers holding cultivable land up to two hectares.

II. The scheme has been made effective from this fiscal itself and as a result, farmers would get one installment before March-end. This programme is part of the government's effort to address farm sector distress.

III. To provide an assured income support to the small and marginal farmers, the government is launching the Pradhan Mantri Kisan Samman Nidhi (PM-KISAN).

- A. Only II is implicit
- B. All I, II and III are implicit
- C. None is implicit
- D. Only I is implicit
- E. Only III is implicit

Direction: In each question below is given a statement followed by three assumptions numbered I, II and III. An assumption is something supposed or taken for granted. You have to consider the following assumption and decide which of the assumption is implicit in the statement.

17. Statement: The Indian authorities have allowed commercial operations to all the airports that were shut after a few fighter jets of the Pakistani Air Force entered the Indian side of Kashmir. The authorities had informed all airlines that airports near the Jammu & Kashmir region and Dehradun have been closed.

Assumptions:

I. The Pakistani Air Force entered into the Indian side of Kashmir after the Indian Air Force entered the Pakistani territory and bombed a terrorist training centre in Pakistan.

II. Several airline executives confirmed that the government has informed them that flights to Jammu, Srinagar, Leh, Amritsar, Dehradun & Dharamshala have been suspended 'till further notice.'

III. One official added that no Notice to Airmen (NOTAM) has been issued yet. It is a notification to the government that the airlines have received, the source in the know said.

- A. None is implicit
- B. Only I is implicit
- C. Both II and III are implicit
- D. Only III is implicit
- E. Only II is implicit

Direction: In the question below, are given a statement followed by three courses of actions numbered I, II and III. On the basis of the information given, you have to assume everything in the statement to be true, and then decide which of the suggested courses of action logically follow(s) for pursuing.

18. Statement: Early-stage startups and small businesses in India have been shying away from hiring women after the government increased paid maternity leave in 2017, a survey shows. An amendment to the Maternity Benefits Act, passed in March 2017, raised paid maternity leave for women from 12 weeks to 26 weeks, benefitting 1.8 million women workers in the organised sector. The law applies to all establishments employing 10 or more people, and the entitlement applies only up to the first two children. LocalCircles,

a citizens' forum which surveyed 9,000 early-stage startups and small businesses, said hiring women who will avail of maternity benefits, which includes six months' paid leave, has turned into a significant economic burden for startups that typically run on shoestring budgets. In the survey, 46% of the respondents said they hired mostly male employees in the last 18 months.

Courses of action:

I. While the government late last year said it will refund employers for seven weeks of pay given to an employee on maternity leave, startups and SMEs said it isn't enough to cover the cost. As per the survey, 65% of the respondents said that even 19 weeks of pay would be too much for them to absorb.

II. According to the latest Monster Salary Index report, women still earn 19% less than their male counterparts in India. This gap has decreased by 1% from last year. Further, the report adds that women-led businesses received only 65% of the funding secured by male-led ones.

III. However, not all small startups agree that maternity benefits need to be scrapped. Rohan Shravan, founder of AI startup Inkers Technology said that among his team of nine employees, three are women, and unlike many firms of its size, they even offer extended paternity leave benefit to employees.

- A. All follow
- B. Neither I nor III follows
- C. Only I follows
- D. None follows
- E. Only III follows

Direction (19 – 22) : Study the given information carefully and answer the questions given below.

Ten boxes P, Q, R, S, T, A, B, C, D and E are arranged in a stack from top to bottom (where the one at the bottom is numbered as 1 and the one at the top is numbered as 10) but not necessarily in the same order. Boxes which are kept at even-numbered position contain different fruits such as apple, pear, orange, litchi and kiwi.

Two boxes are kept between the box which contains orange and Box A. The box which contains orange is kept at either 8th or 10th position in the stack. Box R is kept above Box P but below Box S. Total number of boxes which contain fruits below and above the box which contains kiwi is the same. Box A is above Box T but not immediately above. The number of boxes kept between box A and Box T is same as the number of boxes kept between box T and Box D. The box which contains pear is kept above the box which contains litchi. Box C is kept immediately above Box Q. Only three boxes are kept between box E and Box D where Box E is kept above box D. Box D doesn't contain Kiwi. The box which contains apple is kept below Box T but not immediately below. Neither box R nor box Q contains Pear. Box B contains apple. The box which contains orange is not kept immediately above Box E.

19. How many boxes are kept between Box C and the box which is kept at fourth from the bottom?

- A. Three
- B. Four
- C. More than four
- D. Two
- E. None of these

20. Which fruit is contained by T?

- A. Litchi
- B. Kiwi
- C. Apple
- D. Orange
- E. None

21. What is the position of Box S from the top of the stack?

- A. First
- B. Second
- C. Fourth
- D. Third
- E. Sixth

22. Which of the following can be said for the box R?

- I. Box R contains Kiwi.
- II. Box R is kept immediate above E.

III. Box R is kept exactly between Box A and Box T.

- A. Only I
- B. Only II
- C. Only III
- D. Both I and II
- E. None of the above

Direction: The question consists of a question and three statements numbered I, II and III given below. You have to decide whether the data provided in which of the statements are sufficient to answer the question. Choose your answer from the options based on this.

23. Eight persons A, B, C, D, E, F, G and H are staying on an eight-storey building. Lowermost floor is numbered 1 and the topmost floor is numbered 8. Who among the following lives on the bottom floor?

- I. B lives 3 floors above F. G lives just above B. One person lives between B and A.
 - II. A lives on an odd-numbered floor. C lives two floors below A.
 - III. E lives just above D. Two persons live between D and H.
- A. I and II
 - B. II and III
 - C. Either I and III or II and III
 - D. Any of two
 - E. All of them

Direction (24 - 27) : Study the information given below and answer the questions based on it.

A, B, C, D, E, F, G, H and I are nine people standing in 3 parallel rows facing north, in such a way that there is an equal distance between adjacent persons. Each row contains three positions. They speak different language Hindi, Marathi, Gujarati, English, Tamil, and Telugu.

- 1) I, D and G are standing in 3 different rows and they all speak a different language.
- 2) One who speaks Gujarati is immediate left of the one who speaks Marathi in Row-1.
- 3) There are 3 students who can speak English and all are standing in different rows.

4) H is standing in row-1 and speaks English. Also, he is at the right end.

5) G speaks neither Hindi nor English and speaks only that language which is not spoken by any other student.

6) One who speaks Tamil is in Row-2 and is diagonally opposite to the one who speaks Hindi and Telugu in Row-3.

7) One who Speaks Telugu in row-2 is in parallel to the students who speak Gujarati in row-1 and Hindi in row-3.

8) B is the only one who speaks Gujarati and is diagonally opposite to A. I is in the second row and D cannot speak English.

9) In Row-3 F is on the extreme right end. And He finds no difficulty to talk to E.

24. Who is standing in the middle of row-3?

- A. B
- B. D
- C. C
- D. A
- E. H

25. Who is immediate neighbour of the one who speaks English in Row-2?

- A. E
- B. A
- C. I
- D. F
- E. C

26. Who is not standing in row-2?

- A. A
- B. C
- C. I
- D. E
- E. None of these

27. Who does not speak English?

- A. H
- B. A
- C. D
- D. C
- E. None of these

Direction (28 - 29) : Read the given passage below and answer the questions. Amid a changing environment, with natural homes of birds getting depleted as natural forests make way for plantations and other such modified

terrains, comes the good news of how the great Indian hornbill adapts to such change. A group of researchers from NCBS-TIFR in Bengaluru and Nature Conservation Foundation in Mysuru observed eight hornbill nests, three located in contiguous forests and five located in modified habitats such as coffee plantations. They found that the birds followed similar nesting behaviour but adapted to the changing environment. The team chose to study the great Indian hornbills nesting in the Anamalai hills. For comparison, the researchers located the study in the modified habitat in the Valparai plateau and the contiguous forests in the Anamalai Tiger Reserve and the Vazhachal Reserve forests. The modified habitat included tea, coffee and cardamom plantations, and tribal settlements.

28. Which of the following is not an apt conclusion on the basis of the information provided?

- A. Some of the nests were discovered during the study with the help of local tribal assistants.
- B. Great hornbills may adapt to habitat modification provided that their key requirements for food and nesting are fulfilled in the habitats like coffee and forest fragments.
- C. Considering that hornbills use same nest over years, protection of these known nest trees and retention of large trees that can be potential nests is absolutely essential.
- D. None of the above.
- E. All of the above.

29. Which of the following is/are a suitable course of action in lieu of the information provided?

- A. Hornbills are secondary cavity nesters and choose cavities formed in large trees for nesting. Also, they are monogamous, and the female, after copulation, seals herself in the hole until the initial breeding period of two-four months is over.

B. The team also highlighted the potential of rainforest fragments and coffee plantation for conservation of hornbills outside of protected areas.

C. In addition, it is necessary to have a diversity of native tree species, particularly figs, laurels and other food plants.

D. Along with other threats such as hunting, modified land use, ensuing forest fragmentation, felling of large trees with the potential for nesting, the loss of fruit bearing trees could also affect hornbill nesting habits.

E. Considering that hornbills use same nest over years, protection of these known nest trees and retention of large trees that can be potential nests is absolutely essential.

30. **Direction:** Study the information given below and answer the questions based on it.

Revenue growth at mid-tier IT services firms such as Hexaware, Zensar, Mphasis and L&T Infotech is set to pick up, boosted by strong deal wins as they see customers keen to invest more in technology projects. While they are projected to outpace large rivals such as Infosys and Wipro in growth, the pressure on their margins is likely to be higher.

Which of the following can be **logically inferred** from the above information?

- A. All indicators show that these mid-tier IT service firms will again grow better than industry average in FY2020. Their pipeline is better than last year. They are growing both existing accounts and getting new logos and deals especially in the last quarter.
- B. It is broad-based growth, across geographies, verticals and service lines, unlike their large peers where we see softness in a few geographies and verticals.
- C. Mid-tier companies are sharpening their overall strategy, by increasing focus on certain markets and businesses than spread thin.
- D. While these firms are growing fast, their margins continue to be under pressure. The pricing pressure in the

traditional segment can erode their margins further.
E. All can be inferred.

Direction (31 – 34) : Study the following information carefully and answer the given questions.

Six persons i.e. M, N, O, P, Q and R who all are sitting around a hexagonal table facing towards the center. They all are of different height and weight such that the one who is the tallest is not the lightest among all. They all are of different age i.e. 14, 22, 28, 30, 35 and 60 but not necessarily in the same order.

The one who is the heaviest among all sits third to the right of N, who is 60 years of age. The one who is twice the age of Q is the third lightest among all. The one who is 35 years of age is the second tallest, who sits second to the right of Q, who is not the immediate neighbour of N. Only one person sits between N and the one who is the third heaviest among all, who is 14 years of age. The one who is younger than Q is not the lightest. Q is shorter than only two people. O's age is half the age of M. M sits third to the right of the one who is the shortest in height among all. The one who is older than P is taller than Q. The one who is 30 years old is the heaviest among all. The one who sits opposite to R is the second heaviest among all. R sits second to the right P. M is taller than the one who is 14 years old.

31. Who among the following faces P?

- A. M
- B. O
- C. N
- D. Q
- E. R

32. Who among the following is the third lightest person?

- A. M
- B. R
- C. N
- D. O
- E. Q

33. Four of the following five are alike in a certain way and hence form a group.

Find the one that does not belong to the group.

- A. O
- B. Q
- C. R
- D. N
- E. P

34. Who among the following is the shortest person in this group?

- A. O
- B. R
- C. P
- D. N
- E. Q

Direction: The question below consists of a question and two statements numbered I and II given below it. You have to decide whether the data provided in the statements are sufficient to answer the question.

35. Among M, N, O, P, Q and R, who got the highest salary?

I. O got more salary than only two persons. N got more salary than M but not the highest. Q got more salary than only R.

II. M got less salary than only two persons. Q got a higher salary than R but less than O. O got less salary than M. N got less salary than P.

A. The data in statement II alone are sufficient to answer the question, while the data in statement I alone is not sufficient to answer the question

B. The data even in both statements I and II together is not sufficient to answer the question

C. The data either in statement I alone or in statement II alone is sufficient to answer the question

D. The data in statement I alone are sufficient to answer the question, while the data in statement II alone is not sufficient to answer the question

E. The data in both statements I and II together is necessary to answer the question

Direction : Study the information given below and answer the questions based on it.

There are 6 persons in a list A, B, C, D, E and F. They got different marks in an examination. C got more marks than D but less than B. E got more marks than F and F got the least marks among them. The one who got the highest marks got 400 marks and the one who got the least marks got 60 marks. The one who got the highest marks, his position in the list is number 1 and the one who got the least marks, his position in the list is number 6.

36. If A got 400 marks and E's position in the list is 2nd last and the persons who got last 3 positions in the list, their average marks is 95, then what will be the total marks of D and E together?

- A. 245
- B. 235
- C. 225
- D. 200
- E. None of these

Direction (37 - 39) : Study the following information carefully and answer the questions given below.

There are five vehicles of different types viz., Bus, Van, Bike, Truck and Jeep in a garage but not necessarily in the same order. They are serviced at different timing in a single day. The duration of their servicing in the garage may or may not be different. The total duration of the servicing in the garage by the mechanic is of 11 hours. There is no gap between the servicing time of all vehicles. The duration of servicing is either a full hour or half an hour but not in one third or one fourth. The van was serviced in the garage from 12:30 pm to 3 pm. Jeep was taken for servicing immediately after the Van. The servicing hour of Jeep in the garage is three hours. The duration of servicing of Truck is more than the duration of servicing of Bike in the garage by 1 hour. Truck was serviced just after the servicing of Bike. The truck was not serviced at the last. The bus was serviced in the garage before Van but not

immediately before. The duration of servicing of the bus is of 1.5 hours. The servicing of the bike is after 6:00 am.

37. Which among the following was serviced from 3:00-6:00 pm?

- A. Bus
- B. Bike
- C. Truck
- D. Jeep
- E. Van

38. Which among the following was serviced just after bus?

- A. Truck
- B. Bike
- C. Van
- D. Jeep
- E. None of these

39. What is the duration (in hours) of the Bike's servicing?

- A. 2.5 hour
- B. 3 hour
- C. 3.5 hour
- D. 1.5 hour
- E. 2 hour

Direction: The question given below consists of a statement, followed by three arguments numbered I, II and III. You have to decide which of the arguments is/are 'strong' arguments and which is/are 'weak' arguments and accordingly choose your answer from the alternatives given below each question.

40. **Statement:** India has conveyed to Russia that it will not be part of the project now to develop a fifth-generation fighter aircraft (FGFA) and may join the programme at a later stage, according to Defence Minister Nirmala Sitharaman. It was conveyed to Russia that they can go ahead with the project and we may join it at a later stage.

Which among the following arguments support the above statement in the best possible manner?

Arguments:

I. India and Russia had signed an inter-governmental agreement for the mega project in 2007, vowing to take the

military ties between the two strategic partners to the next level.

II. However, the project has been stuck for the last 11 years as there have been serious differences between the two sides on sharing the cost of developing the jet, technologies to be used in it and number of aircraft to be produced.

III. The government is adopting a layered approach to achieve the final goal of theatre command and that the thrust was on a bottom-up approach.

- A. None is strong.
- B. Only III and II are strong.
- C. Only III is strong.
- D. All except III and I are strong.
- E. All are strong.

41. After GST and demonetisation, rising interest rates are set to hurt SMEs. Interest rates for loans against property (LAP) extended to small and medium sized enterprises (SMEs) are set to rise in the coming months of 2018. Rising interest rates, in addition to the muted operating environment for small businesses in India, will lead to an increase in delinquencies on LAP extended to SMEs. The introduction of the goods and services tax (GST) in July 2017 and the government's demonetization policy have placed stress on the SME sector, which rising interest rates will exacerbate.

Which of the following can be **logically inferred** from the statement above?

- A. In addition to rising delinquencies over the last few years would force lenders to be more cautious while underwriting loans. This would limit refinancing options, adversely affecting existing borrowers.
- B. But losses will be limited because these loans are secured and have relatively low loan-to-value ratios.
- C. Rising interest rates will limit refinancing options and increase repayment amounts, increasing risks for asset backed securities (ABS) backed by LAP to SMEs.
- D. The ABS (asset backed securities) backed by LAP extended to SMEs have non-amortizing cash reserves,

substantial excess spread and the possibility to extend the life of the loans and hence the life of the transactions.

E. None can be inferred.

Direction: Two statements are followed by three conclusions I, II and III. You have to consider the statements to be true, even if they seem to be at variance from commonly known facts. You have to decide which of the given conclusions can definitely be drawn from the given statements and indicate your answer accordingly.

42. **Statements:**

I. The world's largest bee — a giant insect roughly the size of a human thumb — has been rediscovered in a remote part of Indonesia in its first sighting in nearly 40 years, researchers said.

II. Despite its conspicuous size, no one had observed Wallace's giant bee — discovered in the 19th century by British naturalist Alfred Russel Wallace.

Conclusions:

I. Several previous expeditions to the region where the bee lives failed to spot it.

II. Indonesia is home to an abundant variety of flora and fauna but there are fears for some animal and insect communities as forests being cut down for agriculture threaten many species' natural habitat.

III. The bee which lives in the Indonesian island region of North Moluccas, makes its nest in termite mounds, using its large fang-like mandibles to collect sticky resin to protect its home from the termites.

- A. Only conclusion I follows
- B. Both conclusions II and III follow
- C. Only conclusion III follows
- D. Only conclusion II follows
- E. Both conclusions I and II follow

Direction: Study the following information carefully and answer the questions given below:

Six people i.e. L, M, N, P, R and S are sitting around a triangular table but not necessarily in the same order. Three of them sit at the corner of the table and

three of them sit in the middle of the side. Some of them are facing inside the table and some of them are facing outside the table. Not more than two persons sit adjacent to each other who are facing the same direction. Two persons sit between R and P. P faces inside. S sits second to the right of R. L faces the opposite direction to R. Only one person sits between N and S who does not sit at the corner of the table. M and N face the same direction as P. M sits 2nd to the left of L.

43. Four of the following five are alike in a certain way and hence form a group. Which is the one that does not belong to that group?
 A. R
 B. M
 C. N
 D. P
 E. L

44. Who amongst the following sits second to the right of the one who sits third to the left of N?
 A. R
 B. L
 C. P
 D. S
 E. None of these

45. How many persons sit between S and N when counted from the right of N?
 A. Three
 B. Two
 C. One
 D. None
 E. None of these

Direction (46 – 47) : In the following questions 3 series are given. You have to find the value of a, b and c by identifying the pattern of the series and then you have to establish the relation among a, b and c?

46. I. 1, 601, 721, 751, a, 766
 II. 753, 769, b, 765, 763, 764
 III. 23, 24, 50, 153, c, 3085
 A. $a > b = c$
 B. $a = b > c$
 C. $a = b < c$

- D. $a > b < c$
 E. None of these

47. I. 102, 107, 117, 134, a
 II. 130, 115, 135, 110, b
 III. c, 80, 120, 300, 1050
 A. $b < a = c$
 B. $b > a = c$
 C. $b = a > c$
 D. $b = a < c$
 E. None of these

Direction (48 – 50) : Study the following information carefully and answer the given questions:

In the diagram, Population Density (in population per square kilometer) and Land Area (in square kilometer) of 4 villages A, B, C and D for the year 2001 is given.

Population Density of a village = Total population of the village / Area (in square km) of the land of the village

Gender Ratio of a village = (Total number of males in a village / Total number of females in a village) × 100

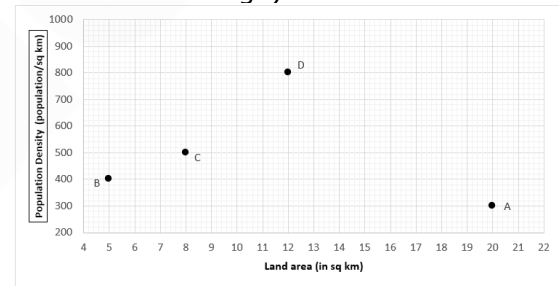

48. Gender ratio of village C is 125 less than that of A. If female population of villages A and C are equal, then find the male population in village A
 A. 1600
 B. 2400
 C. 4400
 D. 2500
 E. None of these

49. If population of female in village D was 4000, then what is the gender ratio of village D?
 A. 120
 B. 60
 C. $71\frac{3}{7}$

Gradeup Green Card
 Unlimited Access to All 700+ Bank & Insurance Mock Tests
[CLICK HERE](#)

- D. 120
- E. None of these

50. Land of a village E is 4 square kilometer. If the population density of a village E in the year 2010 was 50% with respect to that in year 2001. In the year 2001, ratio of population density of a village B to that of village E is 1 : 4, then what was the population of village E in the year 2010?

- A. 3200
- B. 1600
- C. 2400
- D. 4800
- E. None of these

Direction (51 - 55) : Study the following information carefully and answer the given questions:

The diagram, given below shows the data related to loan fair. In total z number of people contacted for a loan fair, from which x number of people visited loan fair and 9600 people shown interest for a loan. Out of the total number of people shown interest for a loan only 32% applied for the loan. Out of the total number of people applied for the loan, only 20% are eligible for a loan. Out of the total number of people eligible for a loan, loan of only y% people are disbursed.

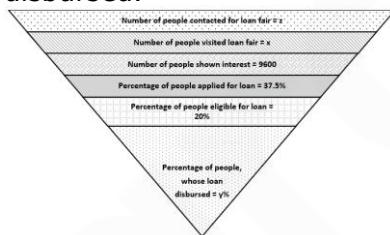

51. If out of the number people who have applied for loan, 2880 were not eligible for a loan, then how many people are eligible for a loan?

- A. 1440
- B. 11520
- C. 360
- D. 720
- E. None of these

52. If 6000 people, who visited loan fair but not shown interest and 7400 people,

who were contacted but did not visit the loan fair, then how many people contacted for the loan fair?

- A. 21000
- B. 24000
- C. 25000
- D. 22500
- E. 23000

53. Ratio of the number of people, who did not visit the loan fair and the number of people, who visited the loan fair but not shown interest is 7 : 5 . If the total number of people contacted for the loan fair is 19200, then find the value of x.

- A. 19200
- B. 16000
- C. 14400
- D. 13600
- E. 12600

54. Loan of 40% of the people did not disbursed who were eligible for a loan, then find the ratio of the number of people, who shown interest and the number of people, whose loan disbursed.

- A. 2000 : 9
- B. 1250 : 24
- C. 2000 : 27
- D. 625 : 24
- E. None of these

55. Number of people who were eligible for a loan but whose loans were not disbursed is equal to the 9% of the number of people who shown interest in the loan but did not apply for a loan. Find the value y.

- A. 12.5
- B. 25
- C. 16.67
- D. 20
- E. None of these

Direction (56 - 58) : Study the following information carefully and answer the given questions:

An apple pie of R cm radius has to cut into x identical pieces. Area of top surface of each piece was 0.77 cm² but later on it was found 50% of pie was rotten so the remaining 50% was cut into (x - 3) pieces of area 0.616 cm² each.

Gradeup Green Card

Unlimited Access to All 700+ Bank & Insurance Mock Tests

CLICK HERE

56. Find the value of X.
 A. 10
 B. 12
 C. 8
 D. 6
 E. None of these

57. Find the circumference of the original pie.
 A. $\frac{88}{50}$ cm
 B. $\frac{88}{25}$ cm
 C. $\frac{176}{25}$ cm
 D. $\frac{176}{50}$ cm
 E. None of these

58. If entire pie would have been cut into 11 identical pieces what would have been top surface area of each piece?
 A. 0.64 cm^2
 B. 0.56 cm^2
 C. 0.28 cm^2
 D. 0.42 cm^2
 E. None of these

Direction (59 – 61) : Study the following information carefully and answer the given questions.

Data below represent number of people required for various project to be completed in various days:

Project	Situation 1		Situation 2	
	Number of workers	Days required	Number of workers	Days required
A	X	88	X + 8	66
B	Y	Y – 1	Y + 6	Y – 6
C	Z ²	75	M ²	108

59. If 64 people were working for Project A, then how many days did it take to complete the work?
 A. 44 days
 B. 22 days
 C. 33 days
 D. 36 days
 E. None of these

60. If in Team P, total number of workers = $0.5Z \times 2M$, then what is the number of days required by Team P to complete Project C?

- A. 75 days
 B. 60 days
 C. 90 days
 D. 80 days
 E. None of these

61. If 0.5 Y people work on project B for 10 days and then 0.5Y people join the project after 10 days. How many days will it take to complete the Project B?
 A. 35 days
 B. 40 days
 C. 45 days
 D. 50 days
 E. None of these

Direction (62 – 66) : Study the following information carefully and answer the given questions.

There were some red, some green and some white balls in a bag. Probability of drawing 1 white ball from the bag is $\frac{1}{3}$. If there were 6 more red balls in the bag, the probability of getting 1 green ball would have been $\frac{1}{30}$ less.

62. If ratio of number of red balls and white balls is 7 : 5, then what is the probability of drawing 2 balls such that one is red and other is white?
 A. $5/29$
 B. $14/87$
 C. $15/58$
 D. $28/87$
 E. None of these

63. If sum of red, green and white balls is 30, then what is the probability of drawing 2 white balls from the bag?
 A. $3/29$
 B. $5/58$
 C. $9/58$
 D. $10/87$
 E. None of these

64. If Probability of drawing 1 green ball from the bag is $\frac{1}{5}$, then what is the probability of drawing 2 balls such that none of them is red?
 A. $3/29$

Gradeup Green Card
 Unlimited Access to All 700+ Bank & Insurance Mock Tests

CLICK HERE

- B. 4/29
- C. 8/29
- D. 8/87
- E. None of these

65. If sum of green and white balls is 16, then what is the probability of drawing 2 balls of same colour?

- A. $\frac{151}{870}$
- B. $\frac{151}{435}$
- C. $\frac{31}{145}$
- D. $\frac{141}{435}$
- E. None of these

66. If probability of drawing 1 ball such that it is not green is $\frac{4}{5}$, then sum of the number of red and white balls is

- A. 20
- B. 30
- C. 24
- D. 16
- E. None of these

67. In the family of Amit, there are 4 members- Amit, his wife, his only son and his only daughter. Three years ago, age of Amit was 4 years more than the sum of the ages of his son and daughter, then what is the present age of their daughter?

- I. Amit's wife is 7 years younger to him and her present age is twice the present age of their son.
 - II. Three years hence, the respective ratio between the ages of his daughter and his son will be 6 : 5.
 - III. Two years hence, the age of Amit will be 1 years less than the sum of the ages of his son and daughter.
- Which of the following statement(s) is/are sufficient to answer the question?
- A. All the three statements together
 - B. Only statement III
 - C. Only statements II and III together
 - D. Only statements I and III together
 - E. Only statements I and II together

68. A starts a business with Rs. 60,000. After 3 months B joins the business with

investment Rs. 45,000. At the end of the year share of A in the total profit is Rs._____. If they earned 40% profit on their total investment in the business at the end of the year, then which of the following will fill in the blank?

- A. Rs. 15120
- B. Rs. 20160
- C. Rs. 25280
- D. Rs. 26880
- E. None of these

Directions (69 - 73): Study the following information carefully and answer the given questions.

In a school 4 students A, B, C and D appeared in an English examination which is consist of 15 short and 4 long questions are asked. Each of short question carry 5 marks and each of long questions carry 10 mark and for a spelling error 0.5 mark is deducted. For not attempting a question, zero marks is awarded. In the English exam, A answered $(x + 6)$ short questions, x long questions and did $(2x + 10)$ spelling errors. Ratio of number of spelling errors made by A and B is 8 : 3. Total marks scored by D is 86. Ratio of short and long questions answered by B In the English exam is 5 : 1 and he scored total 102 marks. C scored 35 marks more in short questions than long questions except spelling errors and the number of spelling errors made by C is equal to the difference of the number of spelling errors made by A and B. Number of short questions answered by D is average of that answered by A and B. Percentage of number of long questions answered among all the question answered by D is 20%. Average of the number of spelling errors made by all four students A, B, C and D is 10. Each student attempts integral number of short as well as long questions.

69. Total marks scored by A is how much less than the total marks scored by B is
- A. 30
 - B. 33
 - C. 35
 - D. 39

Gradeup Green Card
Unlimited Access to All 700+ Bank & Insurance Mock Tests

[CLICK HERE](#)

E. None of these

70. Average number of short questions answered by A, B, C and D is 11.75, then the total marks scored by C in the English exam is

- A. 70
- B. 75
- C. 86
- D. 93
- E. None of these

71. Ratio of the total number of questions answered by B and that by D is

- A. 4 : 3
- B. 4 : 5
- C. 6 : 5
- D. Cannot be determined
- E. None of these

72. A student E, scored 30 marks more than that by C, whose total marks is more than that by A but less than that by D. If the number of spelling errors made by E are 10 more than that by C, then the total marks scored by C is what percent less than that by E?

- A. 37.5%
- B. $33\frac{1}{3}\%$
- C. 25%
- D. 30%
- E. None of these

73. Sum of the total number of long questions answered by A, B and D is

- A. 7
- B. 8
- C. 9
- D. 10
- E. None of these

Direction (74 - 78) : Study the following information carefully and answer the given questions.

The following chart shows the opening, closing, high and low price of a share of a company XYZ on given 5 days-Monday, Tuesday, Wednesday, Thursday and Friday.

Opening and closing price of the shares of the company XYZ are represented by

ceiling and floor of the black box and floor and ceiling of the white box respectively. The high and low price of the share of the company XYZ are represented by ceiling and floor of the line respectively.

For example: On Monday, opening price = 60, closing price = 52, high price = 66 and low price = 40

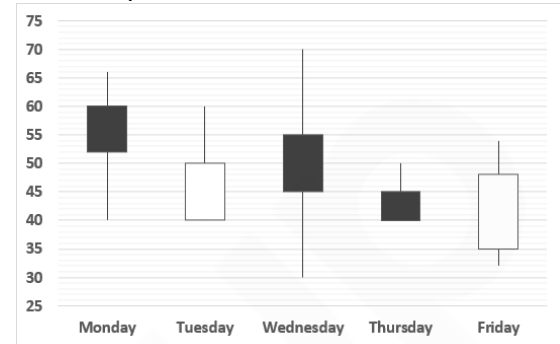

74. What is the ratio of average high price and average low price of the share of the company XYZ on Monday, Tuesday, Wednesday and Friday?

- A. 4 : 3
- B. 5 : 4
- C. 5 : 3
- D. 10 : 3
- E. None of these

75. A trader, bought 150 shares of the company XYZ on opening price of Tuesday and sold 40% these shares on highest price of the share on Thursday and rest on opening price of Friday. Rate of commission while buying the shares is Flat Rs. 200 and while selling it is 8% of the selling price, then what is the total loss incurred by the trader in this transaction?

- A. Rs. 488
- B. Rs. 542
- C. Rs. 552
- D. Rs. 826
- E. None of these

76. A trader, bought X shares of the company XYZ on Wednesday and sold 20% of the shares on Wednesday itself. If he sold $\frac{4}{9}$ th of the remaining shares on closing price of the Thursday and the remaining shares on opening price of Friday. If rate on commission while selling

Gradeup Green Card

Unlimited Access to All 700+ Bank & Insurance Mock Tests

[CLICK HERE](#)

the shares is Rs. 100 for sales amount upto Rs. 3000 and 10% above that amount. If on Friday he gets Rs. 5240 for selling shares after deduction of commission, then the value of x is

- A. 240
- B. 270
- C. 300
- D. 360
- E. None of these

77. A trader, bought 250 shares of the company XYZ on Monday. Commission while buying shares per lot (each time) up to Rs. 5000 is flat Rs. 250 and above that 5% of the difference amount. He sold $\frac{3}{5}$ th of shares on Tuesday closing price and remaining at high price of Wednesday. Commission while selling shares per lot (each time) up to Rs. 4000 is flat Rs. 100 and above that 8% of the difference amount. In this transaction he made profit of Rs. 130, then at what price he bought the shares?

- A. Rs. 52
- B. Rs. 65
- C. Rs. 54
- D. Rs. 56
- E. None of these

78. Average closing price of shares of the company XYZ is what percent more than the average opening price for the given 5 days?

- A. 5%
- B. 20%
- C. 10%
- D. 8%
- E. None of these

Direction: Each question below is followed by two statements I and II. You have to determine whether the data given in the statement is sufficient for answering the question. You should use the data and your knowledge of Mathematics to choose the best possible answer.

79. In an examination, Ravi scored ' x '% marks but failed by 102 marks. In the same examination Ram scored $(3x - 4)$ % marks, thus scored 78 marks above passing marks. Find the value of ' x '.

Statement I: Maximum marks of the examination are 600.

Statement II: Difference between the marks obtained by Ravi and Ram is 180.

- A. The data in Statement I alone are sufficient to answer the question, while the data in Statement II alone are not sufficient to answer the question.
- B. The data in Statement II alone are sufficient to answer the question, while the data in Statement I alone are not sufficient to answer the question.
- C. The data either in Statement I or in Statement II alone are sufficient to answer the question.
- D. The data in both Statements I and II together are necessary to answer the question.
- E. The data even in both Statements I and II together are not sufficient to answer the question.

Direction: Each question below is followed by two statements I and II. You have to determine whether the data given in the statement is sufficient for answering the question. You should use the data and your knowledge of Mathematics to choose the best possible answer.

80. Find the length of Train A.

Statement I: Train A of length $(x + 50)$ m can cross a man moving at the speed of 5 m/s in the opposite direction of that of train A in 10 seconds. It can cross the same man in 15 seconds if he is moving in the same direction.

Statement II: Train A of length $(x + 50)$ m can cross another train B of length $(x + 150)$ m moving in the opposite direction at a speed of 10 m/s in 20 seconds. It can cross train B in 28 seconds if train B is standing on the platform.

- A. The data in Statement I alone are sufficient to answer the question, while the data in Statement II alone are not sufficient to answer the question.
- B. The data in Statement II alone are sufficient to answer the question, while the data in Statement I alone are not sufficient to answer the question.

Gradeup Green Card
Unlimited Access to All 700+ Bank & Insurance Mock Tests

[CLICK HERE](#)

C. The data either in Statement I or in Statement II alone are sufficient to answer the question.

D. The data in both Statements I and II together are necessary to answer the question.

E. The data even in both Statements I and II together are not sufficient to answer the question.

81. According to the Union Budget 2019-20, the government has proposed to allocate how much amount for PSU Bank recapitalisation?

- A. Rs 75,000 crore
- B. Rs 80,000 crore
- C. Rs 90,000 crore
- D. Rs 70,000 crore
- E. Rs 60,000 crore

82. Which insurance company has launched a specially designed mentorship program 'Wings', to empower the female workforce?

- A. Life Insurance Corporation of India
- B. Bajaj Allianz Life Insurance
- C. Aviva Life Insurance
- D. Bharti AXA Life Insurance
- E. Aegon Life Insurance

83. Abhijeet Gupta, a sports person is associated with which sports?

- A. Hockey
- B. Chess
- C. Basketball
- D. Golf
- E. Volley Ball

84. In the Union Budget 2019-20, how much amount has been allocated for the Indian Railways?

- A. Rs 55,837 crore
- B. Rs 65,837 crore
- C. Rs 70,000 crore
- D. Rs 75,837 crore
- E. Rs 85,837 crore

85. The Government of India, the Government of Kerala and the _____ signed a Loan Agreement of USD 250 million for the First Resilient Kerala Program to enhance the State's

resilience against the impacts of natural disasters and climate change.

- A. Asian Infrastructure Investment Bank
- B. Asian Development Bank
- C. World Bank
- D. International Monetary Fund
- E. None of these

86. Which of the following state government has launched the flagship scheme 'Mukhyamantri Yuva Swabhiman Yojana'?

- A. Uttar Pradesh
- B. Punjab
- C. Haryana
- D. Madhya Pradesh
- E. None of these

87. What is the target (in terms of GDP) of fiscal deficit for financial year 2019-20?

- A. 4.6 %
- B. 4 %
- C. 3.3 %
- D. 3 %
- E. 3.5%

88. Which State Government has launched the scheme "Jalamrutha"?

- A. Uttarakhand
- B. UP
- C. Sikkim
- D. Karnataka
- E. Tamil Nadu

89. Which bank has partnered with MIXchange Trade Receivables Discounting System (TReDS) platform for MSME bill discounting?

- A. State Bank of India
- B. Bank of Baroda
- C. Bank of Maharashtra
- D. Bank of India
- E. Corporation Bank

90. Who won the gold medal in the World University Game in the 100m dash event in Italy?

- A. Dutee Chand
- B. Hima Das
- C. PU Chitra
- D. Mandeep Kaur
- E. None of the above

91. Who won the International Cricketer of the Year Award in CEAT Cricket Rating (CCR) Awards 2019?

- A. Rohit Sharma
- B. Kagiso Rabada
- C. Jonny Bairstow
- D. Virat Kohli
- E. Mahendra Singh Dhoni

92. Which of the following plan adopted by Northeast Frontier Railway (NFR) to keep wild elephants away from train tracks that have won the 'Best Innovation Award'?

- A. Plan Bird
- B. Plan Ant
- C. Plan Bee
- D. Plan Bat
- E. None of these

93. Reserve bank of India (RBI) has finalised three years roadmap to improve regulation and supervision of the central bank. What is the name of the roadmap?

- A. Unnati 2022
- B. Upkar 2021
- C. Umang 2022
- D. Utkarsh 2022
- E. Uphar 2022

94. What is the theme of International Day of Happiness 2019?

- A. Have right to live happy
- B. Forgotten Sufferers
- C. Never Alone
- D. Happier Together
- E. Live Happy

95. Deposits in Jan Dhan accounts have crossed how much mark

- A. Rs 50 thousand crore
- B. Rs 75 thousand crore
- C. Rs 1 lakh crore
- D. Rs 1.25 lakh crore
- E. Rs 1.50 lakh crore

96. Who is the first female pilot to enter the Atlantic Ocean solo in a light Space Aircraft (LSA)?

- A. Aarohi Pandit
- B. Keithair Misquitta
- C. Avani Chaturvedi
- D. Mohana Singh

E. Bhawana Kanth

97. According to the survey conducted by the Randstad Employer Brand Research (REBR) 2019, which company is India's most attractive employer brand?

- A. Google India
- B. Amazon India
- C. Microsoft India
- D. Sony India
- E. Infosys

98. As per Forbes World's Best Bank survey, which of the following banks has been identified as number one bank by customers in India?

- A. ICICI Bank
- B. HDFC Bank
- C. State Bank of India
- D. Punjab National Bank
- E. None of these

99. Recently Pinaka has been turned from Rocket System into Guided Missile, which has been manufactured in India. Pinaka is developed by which Organization?

- A. ISRO
- B. DRDO
- C. ISSDC
- D. SAC
- E. SHAR

100. Receivables Exchange of India Ltd (RXIL) was incorporated on 25th February 2016 as a joint venture between National Stock Exchange of India Limited (NSE) and _____.

- A. IDBI
- B. NABARD
- C. SIDBI
- D. BSE
- E. RBI

101. The fifth character of IFSC Code is 0 (zero) and reserved for _____.

- A. future use
- B. account information
- C. branch location
- D. cash withdrawal
- E. branch city

102. Which of the following companies has signed an agreement with Ministry of

Housing and Urban Affairs (MoHUA) to enhance its Swachh Bharat e-Learning Portal features?

- A. Microsoft India
- B. Amazon India
- C. Oil and Natural Gas Corp
- D. Facebook India
- E. Bharat Petroleum Corporation Limited

103. Which of the following committees has been constituted by the Reserve Bank of India to review existing state of mortgage securitisation in India and suggest measures to develop market further?

- A. T. N. Manoharan committee
- B. Harsh Vardhan committee
- C. Sunil Mehta committee
- D. Arjit Basu committee
- E. Rajnish Kumar committee

104. The lenders of Essar Steel have told the Supreme Court that the NCLAT has misconstrued and misinterpreted the provisions of the Insolvency and Bankruptcy Code (IBC) to such an extent that the statute itself has been literally rewritten. What is the full form of NCLAT?

- A. National Company Law Appellate Terminal
- B. National Company Law Appellate Tribunal
- C. National Company Law Appellate Treaty
- D. National Commission of Law Appellate Tribunal
- E. None of these

105. Which of the following is not one of the areas in which gender parity is measured for the Global Gender Gap Report?

- A. Health
- B. Education
- C. Economics
- D. Politics
- E. Environment

106. Which of the following banks and the Commonwealth Bank of Australia (CommBank) has teamed up for 'World First' Blockchain Bond Transaction?

- A. Asian Development Bank

- B. Reserve Bank of India
- C. Asian Infrastructure Investment Bank
- D. Federal Reserve System
- E. World Bank

107. Which bank has signed an agreement to buy a stake in a subsidiary of BSE's India International Exchange (INX)?

- A. AXIS Bank
- B. HDFC Bank
- C. ICICI
- D. Yes Bank
- E. SBI

108. The NewSpace India Ltd. (NSIL) is the new commercial arm of _____.

- A. Defence Research and Development Organisation (DRDO)
- B. Bhabha Atomic Research Centre (BARC)
- C. Indian Space Research Organisation (ISRO)
- D. National Aeronautics and Space Administration (NASA)
- E. None of these

109. On 3rd March 2019, central government approved the proposal for setting up of a "Centre for Disability Sports" in which city?

- A. Lucknow
- B. Visakhapatnam
- C. Kochi
- D. Gwalior
- E. Pune

110. Trading of priority sector lending certificates (PSLCs) on the government's _____ portal by banks will attract integrated goods and services tax.

- A. e-vishnu
- B. e-indra
- C. e-kuber
- D. e-shiva
- E. e-mohini

111. Which state/UT has topped the list of states with the maximum percentage of Pradhan Mantri Ujjwala Yojana (PMUY) beneficiaries availing at least four refills?

- A. Uttarakhand
- B. Gujarat

- C. Delhi
- D. Tamil Nadu
- E. Himachal Pradesh

112. Which of the following countries hosted the G-20 Finance Ministers and Central Bank Governors' meeting?

- A. Fukuoka, Japan
- B. Beijing, China
- C. New Delhi, India
- D. Sydney, Australia
- E. Paris, France

113. The Union Government has constituted a Working Group for the revision of the current series of Wholesale Price Index (WPI). Who is the chairman of the 18-member committee?

- A. Prof. Aman Mishra
- B. Dr. Ratan Jain
- C. Sarita Singh
- D. Prof. Ramesh Chand
- E. None of these

114. Who has been appointed Managing Director (MD) of the National Housing Bank (NHB)?

- A. Sarada Kumar Hota
- B. Siddh Nath Singh
- C. Israr Ahmed
- D. Biswa Sarma
- E. T Latha

115. Which of the following countries inaugurated the first model village built with Indian assistance?

- A. Nepal
- B. Sri Lanka
- C. Bangladesh
- D. Bhutan
- E. Japan

116. Recently, which city has declared as the UNESCO World Heritage Site?

- A. Lucknow
- B. Jaipur
- C. Bhopal
- D. Jodhpur
- E. Indore

117. Persons resident in India as defined under Foreign Exchange Management Act, 1999 are eligible to invest in

Sovereign Gold Bond (SGB). Eligible investors include Individuals, HUFs, trusts, _____ and charitable institutions.

- A. Leaders
- B. Foreign customers
- C. PSBs
- D. NBFC
- E. Universities

118. Which company has announced the launch of its new Wings application in India on Google Play Store?

- A. Airtel
- B. MTNL
- C. Vodafone
- D. BSNL
- E. Jio

119. Who has been appointed as Additional Director on the board of YES Bank for a period of two years?

- A. R Gandhi
- B. R S Pathak
- C. Baba Kalyani
- D. Bhuvneshwar Prasad Sinha
- E. None of these

120. The World Happiness report 2019 was released by UN & Sustainable Development Solutions Network in which Finland has been ranked on top. The report was produced in partnership with _____.

- A. Economist Intelligence Unit (EIU)
- B. World Bank
- C. Institute of Economics and Peace
- D. World Intellectual Property Organization
- E. Ernesto Illy Foundation

Direction (121 – 123) : Read the given passage carefully and answer the questions that follow. Certain words are printed in bold to help you locate them while answering some of these.

Meritocracy has become a leading social ideal. Politicians across the ideological spectrum continually return to the theme that the rewards of life – money, power, jobs, university admission – should be distributed according to skill and effort. The most common metaphor is the "even

playing field" upon which players can rise to the position that fits their merit. Conceptually and morally, meritocracy is presented as the opposite of systems such as hereditary aristocracy, in which one's social position is determined by the lottery of birth. Under meritocracy, wealth and advantage are merit's rightful compensation, not the fortuitous windfall of external events.

Most people don't just think the world *should* be run meritocratically, they think it *is* meritocratic. In the United Kingdom, 84% of respondents to the 2009 British Social Attitudes survey stated that hard work is either "essential" or "very important" when it comes to getting ahead, and in 2016 the Brookings Institute found that 69% of Americans believe that people are rewarded for intelligence and skill. Respondents in both countries believe that external factors, such as luck and coming from a wealthy family, are much less important. While these ideas are most pronounced in these two countries, they are popular across the globe.

Although widely held, the belief that merit rather than luck determines success or failure in the world is demonstrably false. This is not least because merit itself is, in large part, the result of luck. Talent and the capacity for determined effort, sometimes called "grit", depend a great deal on one's genetic endowments and upbringing.

This is to say nothing of the fortuitous circumstances that figure into every success story. In his 2016 book *Success and Luck*, the US economist Robert Frank recounts the long-shots and coincidences that led to Bill Gates's stellar rise as Microsoft's founder, as well as to Frank's own success as an academic. Luck intervenes by granting people merit, and again by furnishing circumstances in which merit can translate into success.

Source:

<https://scroll.in/article/956459/the-myth-of-meritocracy-leads-the-rich-and-powerful-to-see-themselves-as-productive-geniuses>

121. What ideas does the author refer to when he/she says, "While these ideas are most pronounced in these two countries, they are popular across the globe."?

- A. Skills and efforts alone can lead to success.
- B. Luck and inheritance grant merit and favourable conditions leading to success.
- C. Merit can lead to success only if you are a resident of UK or America.
- D. External efforts like inheritance and luck do not affect the chance of being rich.
- E. Both A & D

122. Which of the following statements can be correctly inferred from the passage?

- A. The idea behind 'even playing field' is to bring everyone to their lowest possible level.
- B. Even though meritocracy is popular all over the world, only UK and America have successfully implemented it.
- C. It is a common fallacy that hard work and skill alone can bring success.
- D. In hereditary aristocracy, a lottery is drawn at the birth to determine his/her career.
- E. None of the above

123. Which of the following correctly describes the tone of the last paragraph?

- A. Fictitious
- B. Factual
- C. Fallacious
- D. Flippant
- E. Forceful

Direction)124 – 127) : Which of the following phrases (i), (ii), and (iii) given below each sentence should replace the phrase printed in bold letters to make the sentence grammatically correct? Choose the best option among the five given alternatives that reflect the correct use of phrase in the context of the grammatically correct sentence. If the sentence is correct as it is, mark (E) i.e., "No correction required" as the answer.

124. The strategy of human lockdown **is being unprecedented in human**

Gradeup Green Card
Unlimited Access to All 700+ Bank & Insurance Mock Tests

[CLICK HERE](#)

history and the World Health Organisation has called it the most “aggressive disease containment effort in history”.

- i. Was unprecedented in human history
 - ii. Was unprecedented during human history
 - iii. Was unprecedented in the history of human beings
- A. Only i
 - B. Only ii
 - C. Only iii
 - D. Both i and iii
 - E. No correction required

125. The Netherlands became a world power in the 17th century, thanks to **enormous wealth generates by its East and West India Companies** which propelled it to the forefront of scientific discovery and artistic endeavor.

- i. enormous wealth generated by its East and West India Companies
 - ii. enormous wealth being generated by its East and West Companies
 - iii. enormous wealth had generated by its East and West Companies
- A. Only i
 - B. Only ii
 - C. Only iii
 - D. Both i and ii
 - E. No correction required

126. The announcement by the king of England **was met with scorn, anger and ridicule on** social media.

- i. Had met on scorn, anger and ridicule in
 - ii. Was meeting of scorn, anger and ridicule on
 - iii. Had been meet with scorn, anger and ridicule on
- A. Only i
 - B. Only ii
 - C. Only iii
 - D. Both ii and iii
 - E. No correction required

127. Dutch author Marieke Lucas Rijneveld has become one of the youngest writers **because shortlisted for a Booker prize**, after their debut novel made the final line-up for the International Booker.

- i. Was to be shortlisted for a Booker Prize
 - ii. To be shortlisted for a Booker Prize
 - iii. To be shortlisted within a Booker Prize
- A. Only i
 - B. Only ii
 - C. Only iii
 - D. Both ii and iii
 - E. No correction needed.

Direction (128 – 130) : Read the given passage carefully and answer the questions that follow. Certain words are printed in bold to help you locate them while answering some of these.

When it comes to English books, it is authors like Kavita Kané, Utkarsh Patel, and, more recently, Saiswaroopa Iyer, who seem to have passionately taken up the cause of feminist revisionist mythology.

Kané has written a string of books over the years that are determinedly feminist in nature. She picks the most unusual characters (sometimes even creates them!) to tell her readers what-may-have-been. Her first was titled *Karna’s Wife: The Outcast’s Queen* (2014), which told the story of Karna through his (fictional) wife, Uruvi.

It is interesting that Kané chose to introduce an entirely new character to tell Karna’s story in the space of mythological fiction. The Mahabharata speaks of no one called Uruvi. Karna is married to Vrushali, Duryodhana’s charioteer’s sister, and to another woman named Supriya. Both are blink-and-miss characters, with little to say or do in the epic. But in Kané’s re-imagined world, Karna’s second wife is Uruvi. She is a woman passionately in love with her husband and plays an active role in his unfolding narrative.

Here, we deal with not one but two subaltern voices – of the woman and of the low caste. Kane’s inspiration for this name seems to have come from some references in later Tamil literature, where Karna’s wife is named Ponnaruvi. However, it is conjectured that Ponnaruvi was an epithet for either Vrushali or Supriya or both.

Kané's next was *Sita's Sister* (2014), where she constructed the life and character of the little-known wife of Lakshmana, Urmila. The Ramayana takes scant notice of her, and when it does, consigns her to what is essentially a 14-year long coma. But Kané imagined her as a living, breathing heroine who holds the fort when everything is crumbling and everyone important has left.

Source:

<https://scroll.in/article/828515/indian-mythology-is-a-new-medium-of-choice-for-feminist-narratives-and-its-working>

128. Given below is a possible inference that can be drawn from the facts stated in the last paragraph. You have to examine the inference in the context of the passage and decide upon its degree of truth or falsity.

'The Ramayana hardly takes any notice of Lakshmana's wife Urmila who held the fort during an attack and was heavily injured by the falling rubble.'

- A. Definitely false
- B. Probably false
- C. The data are inadequate
- D. Probably true
- E. Definitely true

129. Which of the following is true about 'Uruvi' with reference to the passage?

- A. The author, through Uruvi, shows casteism in the Mahabharata, which was not present in the original version.
- B. The author created Uruvi all by herself without any historical reference.
- C. The author feels that the Mahabharata had done injustice to Uruvi by telling her story from Karna's point of view.
- D. In the original version of the Mahabharata, Uruvi is completely ignored in Karna's story.
- E. None of the above.

130. Which of the following statements is NOT true with respect to the passage?

- A) Kavita Kané, Utkarsh Patel, and Saiswaroopa Iyer are writing the mythology from a female perspective.
- B) Uruvi is not completely fictional.

C) According to Kavita Kané only people belonging to the low caste were second class citizens.

- A. Only A
- B. Both A & B
- C. Both B & C
- D. Only C
- E. None are correct

Direction (131 – 135) : The following question carries four statements, each of which have been jumbled. You have to unjumble these parts and answer the questions that follow.

1) A force within a field (A)/ moulds a young, naive person into (B) / the word mentor is usually (C)/ applied to the one who (D)

2) Careers and not just at the start as (A)/ it is important throughout our (B)/ a good mentor can help one to (C)/ navigate one's career successfully (D)

3) May not be when we meet them the most (A)/ a common perception when seeking (B)/ a mentor in that area is that we should (C)/ do it when we are new to a profession but that (D)

4) In reality, that's not always the (A)/ dynamic or the demographic, of the mentor-mentee relationship, (B)/ guidance too, especially at the workplace (C)/ as capable grownups need (D)

131. What should be the correct sequence of statement 1?

- A. CDBA
- B. ABCD
- C. BDCA
- D. CADB
- E. DBCA

132. What should be the correct sequence of statement 2?

- A. CDAB
- B. ACDB
- C. BACD
- D. BDAC
- E. CBAD

133. What should be the correct sequence of statement 3?

- A. DBAC
- B. ACDB

- C. BCAD
- D. BCDA
- E. ABCD

134. What should be the correct sequence of statement 4?

- A. ABCD
- B. ABDC
- C. DCAB
- D. CDBA
- E. CABD

135. Which one of the four sentences does not fit into the major theme of the paragraph?

- A. 1
- B. 2
- C. 3
- D. 4
- E. None of these

Direction: In each of the questions given below, a passage has been given which are either situational based or describes a scenario. Below each passage, a question has been given which is framed to make you to infer something out of it. Mark out the correct inference as your answer.

136. A gang of professional kidnapers in Bihar abducts men who demand dowry and gets them to marry the women without taking money. The gang, led by Hukam Singh (Jaaved Jaferi), presumably does well for itself, since Hukam lives in what appears to be a palace. The men dragooned into marriage are miserable. The women should be too, but aren't.

According to the sentence, what is expected from the women?

- A. Wretched
- B. Troubled
- C. Injured
- D. Downtrodden
- E. Elated

Direction (137 – 139) : Read the given passage carefully and answer the questions that follow. Certain words are printed in bold to help you locate them while answering some of these.

The 150-kilometre road trip from Narnaul to Delhi took all of three hours. For young Ashok Khemka, it was well worth the effort. The newly minted IAS officer, posted in Narnaul, had a date with a charming young woman in Delhi and was keen to see her. The young lady in question was his fiancée and Ashok, on his maiden posting as an IAS officer of the Haryana cadre, was naturally eager to meet her as often as possible.

As a member of the 1991 batch of LBSNAA in Mussoorie, he had found himself in the crosshairs of groom hunters. **Ambitious parents of marriageable daughters descended (and possibly still do) on the academy on an annual basis to stalk young trainees in the hope of finding an "IAS match"**. Khemka had managed to evade them all. It was in Delhi that he had met Jyoti, the woman destined to illuminate his home.

She had graduated from the University of Delhi and was contemplating a course in journalism. But Jyoti's father had taken a shine to Khemka and was keen on the match. Jyoti had a deep respect for her father's opinion, so she had decided to go with the flow. Jyoti and Ashok were engaged in a quiet ceremony at her home on the auspicious occasion of Dussehra in 1993. Every alternate weekend, he would head to Shakti Nagar in Delhi to meet her, before hightailing it back to Narnaul. He had no idea that someone was keeping tabs on his movements.

As a sub-divisional officer (SDO), Khemka reported to the deputy commissioner of the district. He had not exactly hit it off with his boss, who fancied himself a man of culture and a connoisseur of music and dance.

Source:

<https://scroll.in/article/957076/ashoka-khemka-ias-has-been-transferred-53-times-in-28-years-when-did-he-first-displease-his-boss>

137. Which of the these presents a contrast to the following sentence as mentioned in paragraph 2: Ambitious parents of marriageable daughters

descended (and possibly still do) on the academy on an annual basis to stalk young trainees in the hope of finding an "IAS match".

- A. Parents prefer educational qualifications of the groom rather than their personality traits.
- B. Very little is known about the daughters' opinion on their marriages with the 'IAS match'.
- C. Parents have resorted to desperate measures to find the ideal groom.
- D. Parents wish to fulfil their daughters' ambition of getting an IAS husband.
- E. None of the above.

138. Which of the following statements is NOT true with respect to the passage?

- A. Jyoti's father met Ashoke at LBSNAA in Mussoorie where he was groom hunting.
- B. Jyoti did not like Ashoke but still met him only because her father wanted her to do so.
- C. Jyoti and Ashok lived together after their engagement.
- A. Only A
- B. Both A & B
- C. Both B & C
- D. Only B
- E. None are correct

139. Which of the following statements can be correctly inferred from the passage?

- I. Ashoke did not get along with his boss with reasons unknown.
- II. Ashok's boss had him followed because Ashok had shown dislike towards his choice of music.
- III. Jyoti did not complete the journalism course because she was married.
- A. Only I
- B. Both I & II
- C. Both II & III
- D. Only II
- E. All are incorrect

Direction (140 – 144) : In the following question, a sentence with two blanks is given, indicating that something has been omitted. The sentence is followed by two columns, I and II, each carrying three words. One or more than one of the three

words mentioned in column I will fill the first blank. Similarly, one or more than one of the three words mentioned in column II will fill the second blank. You have to identify the correct pair(s) of words that would fill the blanks to make the sentence grammatically correct and meaningful. Then mark the relevant option as your answer.

140. The recent ___ I ___ regarding language use and learning ___ II ___ on the primacy of communicative activities in the classroom.

- | | |
|-----------|-------------|
| I. | II. |
| a. ideas | d. rests |
| b. evolve | e. insist |
| c. theory | f. adequate |
- A. a-e
 - B. a-d & c-d
 - C. c-d
 - D. None of the given options
 - E. b-e & a-f

141. The new restaurant has already become a huge ___ I ___ with people ___ II ___ up for hours for a seat each night.

- | | |
|------------|-------------|
| I. | II. |
| a. failure | d. queuing |
| b. forfeit | e. lining |
| c. success | f. ignoring |
- A. c-d
 - B. a-e & b-e
 - C. None of the given options
 - D. c-f & c-e
 - E. b-d

142. French revolutionaries ___ I ___ death by guillotine to be a more ___ II ___ method of execution.

- | | |
|----------------|-------------|
| I. | II. |
| a. disregarded | d. humane |
| b. considered | e. cruel |
| c. neglected | f. merciful |
- A. a-d, c-f, a-e
 - B. b-d & b-e & b-f
 - C. a-e & a-f
 - D. c-f & c-d
 - E. None of the given options

Gradeup Green Card
Unlimited Access to All 700+ Bank & Insurance Mock Tests

[CLICK HERE](#)

143. When we _____ I _____ a repayment of a loan instalment, we _____ II _____ the amount of the loan.

- | | |
|--------------|----------------|
| I. | II. |
| a. withhold | d. reduce |
| b. executing | e. increase |
| c. make | f. calculating |

- A. b-f, a-e & c-f
- B. None of the given options
- C. c-d
- D. b-e
- E. a-d & a-e

144. The petrol market is _____ I _____ so fast that some major petroleum companies have _____ II _____ refining petrol.

- | | |
|---------------|-----------------|
| I. | II. |
| a. shrinking | d. rejects |
| b. diminished | e. discontinued |
| c. declining | f. terminate |

- A. c-e & a-d
- B. a-e
- C. b-f & c- d
- D. a-d & c-f
- E. None of the given options

Direction (145 – 147) : Read the given passage carefully and answer the questions that follow. Certain words are printed in bold to help you locate them while answering some of these.

Defence expenditure is an important component of national security and every country allocates a significant portion of its resources for this purpose. However, given the scarcity of resources and the competing demands from other sectors, a nation’s ability to meet all its Defence requirements is not unlimited. Even the United States, the only military superpower, is unable to afford many of its major programmes, forcing it to scale down the number of items to be procured. The sheer size of the Defence budget and its impact on other sectors of the economy thus, more often raises the question as to how much a country can afford for its Defence.

In the absence of any clear framework of evaluating affordability of Defence spending, many analysts tend to view the same from the perspective of a country’s share of Defence in gross domestic

product (GDP) over a period of time, or by comparing these shares with those of other countries. This method of relative measurement, however, suffers from **ambiguities** as it does not take into account a country’s specific security concerns and the economic compulsions in its totality. In the global context, the affordability of military spending of some of the world’s major military spenders varies not only in degree but also from time to time. While the variation in the degree of affordability indicates the changing security threats that are perceived differently by countries, the fluctuation in affordability over time points to the fact that what may be affordable at one point in time, may not be so at another time. Among the major powers, except for Japan, no other country has been able to sustain consistently high level of Defence spending (in percentage of GDP) over a length of time. The macro economy, which guides major spending heads of the government, could be a factor in controlling Defence spending over a period of time. In the US, the present level of military spending has contributed to fiscal distress, raising doubts whether such large-scale military spending is affordable or sustainable in the future.

Source:

https://idsa.in/jds/2_1_2008_IndiaAffordableDefenceSpending_LKBehera

145. What does the author mean by “...a nation’s ability to meet all its Defence requirements is not unlimited.”?

- A. National expenditure is defined by the allotment made for the defence sector and all other sectors receive their funding beyond that.
- B. The defence expenditure has remained within the government’s desired objectives of budgetary balance, economic stability and equitable growth.
- C. National expenditure cannot focus only on defence sector as there are other sectors that also require funding and resources are limited.
- D. A nation cannot meet all its defence requirements as resources are often

Gradeup Green Card
 Unlimited Access to All 700+ Bank & Insurance
 Mock Tests

CLICK HERE

limited which has to be equally distributed among all sectors in a nation. E. A nation can only meet its defence requirements once all other sectors have been properly funded which makes its options limited in the defence sector.

146. Which of the following is either a synonym or an antonym of the highlighted word used in the passage?

AMBIGUITIES

- I. Equivocations
- II. Luminosities
- III. Transparencies
- A. Only III
- B. Both I and III
- C. Both II and III
- D. Both I and II
- E. All of these

147. Which of the following statements is true about affordability of military spending based on the given passage?

- I. Military spending is a constant entity in a country's budget and is only affected by the demands of other sectors on national expenditure.
- II. One can analyse what a country considers as a security threat by observing the variation in the degree of affordability of military spending.
- III. Critics often question the affordability or sustainability of large-scale military spending.
- A. Only III
- B. Both I and III
- C. Both I and II
- D. Both II and III
- E. All of these

Direction: In the following question, a passage is given which describes a situation or a scenario. A question is asked with reference to the passage. Mark the option that correctly answers that question.

"In the midst of a hot dreary summer, there now sits a lonely drummer. All the beats and music have now drowned in the humdrum life going out of bound, leaving behind this lonely dreamer."

148. What is the author's approach towards the above passage?

- A. Derisive
- B. Gloomy
- C. Aggressive
- D. Apologetic
- E. Motivating

Direction (149 – 151) : Read the given passage carefully and answer the questions that follow. Certain words are printed in bold to help you locate them while answering some of these.

Good Food is First Food. It is not junk food. It is the food that connects nature and nutrition with livelihoods. This food is good for our health; it comes from the rich _____ (A) _____ of our regions; it provides employment to people. Most importantly, cooking and eating it gives us pleasure.

In 2013, we had published the first edition of *First Food* series. I had written then that food is about culture and biodiversity. We often do not think that food diversity, indeed cultural diversity, is linked to the diversity in the biological world. We argued then that we must celebrate the knowledge of plants and their properties and how best to cook them to bring out the flavours and smells. We said then — and we are saying again now — that only when we value the biodiversity on our plates, will we be able to protect the biodiversity in the wild.

In 2017 came the second edition *First Food: Culture of Taste*. In this book, as in the first, we offered recipes of foods along with the knowledge of plant diversity. We did this because it was becoming clear the world was (and is) facing an obesity pandemic — much of the food we eat today is bad for health, with no nutrition or goodness. More importantly, it is now clear that this change in our diet — moving away from home-cooked, nutritious foods borne out of culinary traditions and age-old knowledge — is not incidental or accidental. We are children of the age of processed and factory-grown foods, who have been transmuted through a deliberate and

subliminal marketing that has changed our habits and our culture of food.

We need a re-discovery of this knowledge of food and culture. All is not lost yet — we still eat home-cooked, bio-diverse and nutritious food. But this scenario is changing rapidly. Already, there is evidence that the incidence of diabetes — a disease with strong links to bad food — is increasing, not just among the affluent but also the poor of urban India.

Source

<https://www.downtoearth.org.in/news/food/good-food-is-first-food-and-we-must-nurture-its-economy-68432>

149. Which of the following word can fill the blank (A) in the first paragraph of the passage?

- A. Mainstream
- B. Biodiversity
- C. Ability
- D. Propaganda
- E. Additional

150. Which of the following is/ are False with reference to the given passage?

- I. Obesity pandemic is occurring in the world today, not only because people do not have access to nutritious food, but also because of stress and lifestyle related issues.
 - II. Advertisements have a negative tendency on our food habits.
 - III. There is an epidemic of diabetes among the urban poor in India.
- A. Only I
 - B. Only III
 - C. Both I and II
 - D. Both II and III
 - E. None of these

151. Rephrase the following segment from the passage to convey a similar idea:

“We said then — and we are saying again now — that only when we value the biodiversity on our plates, will we be able to protect the biodiversity in the wild.”

- A. Food variety allows us to appreciate nature better.
- B. Food variety is essential for the protection of wildlife.

C. A vegan lifestyle is more effective in giving us a good health.

D. Food variety allows us better understanding and thereby higher impetus to protect the natural variety of the country.

E. None of these.

Direction: In the following question, a passage is given which describes a situation or a scenario. A question is asked with reference to the passage. Mark the option that correctly answers that question.

“When another old cave is discovered in the south of France, it is not usually news. Rather, it is an ordinary event. Such discoveries are so frequent these days that hardly anybody pays heed to them. However, when the Lascaux cave complex was discovered in 1940, the world was amazed. Painted directly on its walls were hundreds of scenes showing how people lived thousands of years ago.”

152. What is the author’s approach towards the above passage?

- A. Dogmatic
- B. Ethical
- C. Cynical
- D. Factual
- E. Humorous

Direction (153 – 155) : Read the given passage carefully and answer the questions that follow. Certain words are printed in bold to help you locate them while answering some of these.

Financial exclusion is the main cause of poverty. Lack of opportunities and access to finance besides financial illiteracy are the main causes of financial exclusion. Financial inclusion is proving to be a major thorn in the path of Indian economic growth. Access to finance by the poor, disadvantaged and unprivileged group is a prerequisite for poverty reduction and social upliftment. One of the main reasons why the large section of the rural population still remains under below poverty line is lack of opportunities and access to finance besides financial

illiteracy. Large sections of the rural population have no access to financial services and their only recourse is to borrow from money lenders, who charge exorbitant rates. Also, ignorance is rife, with concepts like insurance virtually unheard of. One of the main reasons why mass poverty is persisting in India is that the problem of financing the poor still remains unresolved (RBI, 2011a), with almost all states show more than 60% of populations below the poverty line. Projections based on NSSO data present a disturbing picture as population cut offs for average consumption for almost all states fall between the sixth and seventh deciles, statistics for which are available in its report "Key indicators of household expenditure in India." Further fine-tuned, they deliver a precise percentage of population below the average spends (Sunday Times, 2012). The large section of population below the expenditure curve also points to a worrying inequity in incomes, something that should concern planners as the government looks to target benefits for those who need them through initiatives like food security and employment guarantees (Sunday Times, 2012).

Source: <http://www.lcbr-archives.com/media/files/Manojkumar-Gandhi.pdf>

153. As per the passage, which of the followings are a prerequisite for poverty reduction and social upliftment?

- I. Financial inclusion of the poor and the under privileged section of the society is a necessary prerequisite for poverty reduction and social upliftment.
- II. Financial exclusion of the poor and the under privileged section of the society is a necessary prerequisite for poverty reduction and social upliftment.
- III. The poor and the under privileged section of the society need to be financially educated in order to reduce poverty and gain social upliftment.

- A. Only III
- B. Both I and III
- C. Both I and II
- D. Both II and III
- E. All of these

154. Given below are five statements from the passage. Choose the statement/statements which is grammatically or contextually incorrect.

- A. One of the main reasons why the large section of the rural population still remains under below poverty line is lack of opportunities and access to finance besides financial illiteracy.
- B. Also, ignorance is rife, with concepts like insurance virtually unheard of.
- C. Financial exclusion is the main cause of poverty.
- D. Further fine-tuned, they deliver a precise percentage of population below the average spends (Sunday Times, 2012).
- E. Financial inclusion is proving to be a major thorn in the path of Indian economic growth.

155. Which of the following options is a correct inference regarding mass poverty from the given passage?

- A. Mass poverty persists in India because the marginal population does not have access to social security.
- B. Mass poverty persists in India because Indians are lazy and don't like to work.
- C. Mass poverty persists in India because the marginal population are uneducated and have no access to mainstream finance providers.
- D. Mass poverty persists in India because there are no mainstream financiers providing financial solutions to the poor.
- E. Mass poverty persists in India as it is a government conspiracy.

###ANSWERS###

1. Ans. B.

The logic for the given arrangement is:
 Step I - In even numbers, group of 2 digits are reversed and in odd numbers, all the digits are reversed.
 Step II - All the numbers are arranged in ascending order from left to right.
 Step III - First odd numbers and then even numbers are arranged in ascending order within the numbers.
 Step IV - Group of 2 digits are multiplied.
 Step V - Add all the digits within the numbers.
 Input: 856347 745982 329584 512379 954267 463512
 Step I: 743658 479528 235948 973215 762459 645321
 Step II: 235948 479528 645321 743658 762459 973215
 Step III: 359248 579248 135246 357468 579246 135792
 Step IV: 151832 351832 31024 152848 351824 33518
 Step V: 20 22 10 28 23 20

2. Ans. C.

The logic for the given arrangement is:
 Step I - In even numbers, group of 2 digits are reversed and in odd numbers, all the digits are reversed.
 Step II - All the numbers are arranged in ascending order from left to right.
 Step III - First odd numbers and then even numbers are arranged in ascending order within the numbers.
 Step IV - Group of 2 digits are multiplied.
 Step V - Add all the digits within the numbers.
 Input: 856347 745982 329584 512379 954267 463512
 Step I: 743658 479528 235948 973215 762459 645321
 Step II: 235948 479528 645321 743658 762459 973215
 Step III: 359248 579248 135246 357468 579246 135792
 Step IV: 151832 351832 31024 152848 351824 33518
 Step V: 20 22 10 28 23 20

3. Ans. D.

The logic for the given arrangement is:

Step I - In even numbers, group of 2 digits are reversed and in odd numbers, all the digits are reversed.
 Step II - All the numbers are arranged in ascending order from left to right.
 Step III - First odd numbers and then even numbers are arranged in ascending order within the numbers.
 Step IV - Group of 2 digits are multiplied.
 Step V - Add all the digits within the numbers.
 Input: 856347 745982 329584 512379 954267 463512
 Step I: 743658 479528 235948 973215 762459 645321
 Step II: 235948 479528 645321 743658 762459 973215
 Step III: 359248 579248 135246 357468 579246 135792
 Step IV: 151832 351832 31024 152848 351824 33518
 Step V: 20 22 10 28 23 20

4. Ans. A.

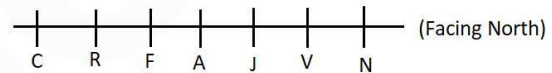

Family Tree,

Symbol in diagram	Meaning
	Female
	Male
	Married Couple
	Siblings
	Difference of a generation

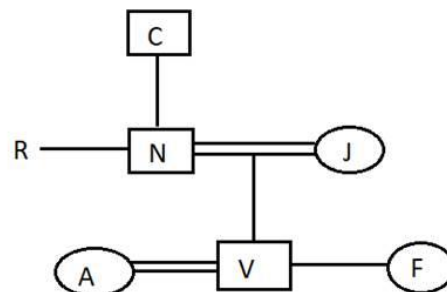

5. Ans. C.

Gradeup Green Card
 Unlimited Access to All 700+ Bank & Insurance
 Mock Tests

CLICK HERE

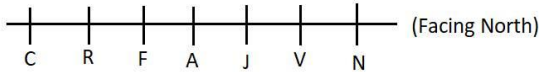

Family Tree,

Symbol in diagram	Meaning
○	Female
□	Male
==	Married Couple
—	Siblings
	Difference of a generation

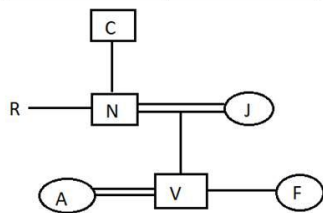

6. Ans. B.

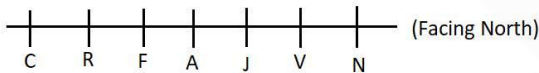

Family Tree,

Symbol in diagram	Meaning
○	Female
□	Male
==	Married Couple
—	Siblings
	Difference of a generation

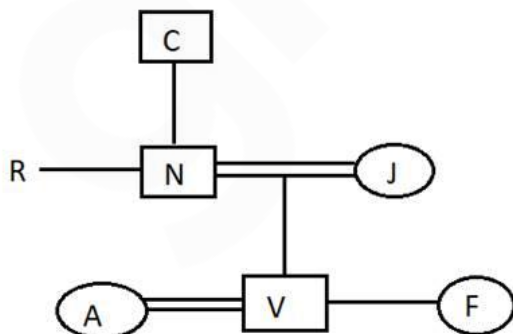

7. Ans. B.

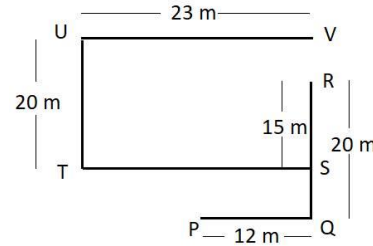

8. Ans. B.

The logic behind the coding is:

Every word is coded by number, symbol & letter.

Logic behind Number:

If Number of letters is even: Add 4 to the total number of letters

If Number of letters is odd: Subtract 3 from the total number of letters

Logic behind symbol:

Starting word	Symbol
W	!
M	\$
S	#
R	+
E	^
P	%
T	~
F	@

Logic behind Letter: 3rd letter of every word from the right is taken.

9. Ans. A.

The logic behind the coding is:

Every word is coded by number, symbol & letter.

Logic behind Number:

If Number of letters is even: Add 4 to the total number of letters

If Number of letters is odd: Subtract 3 from the total number of letters

Logic behind symbol:

Starting word	Symbol
W	!
M	\$
S	#
R	+
E	^
P	%
T	~
F	@

Logic behind Letter: 3rd letter of every word from the right is taken.

10. Ans. C.

The logic behind the coding is:

Every word is coded by number, symbol & letter.

Logic behind Number:

If Number of letters is even: Add 4 to the total number of letters

If Number of letters is odd: Subtract 3 from the total number of letters

Logic behind symbol:

Starting word	Symbol
W	!
M	\$
S	#
R	+
E	^
P	%
T	~
F	@

Logic behind Letter: 3rd letter of every word from the right is taken.

11. Ans. D.

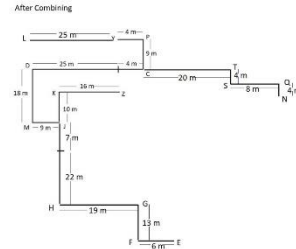
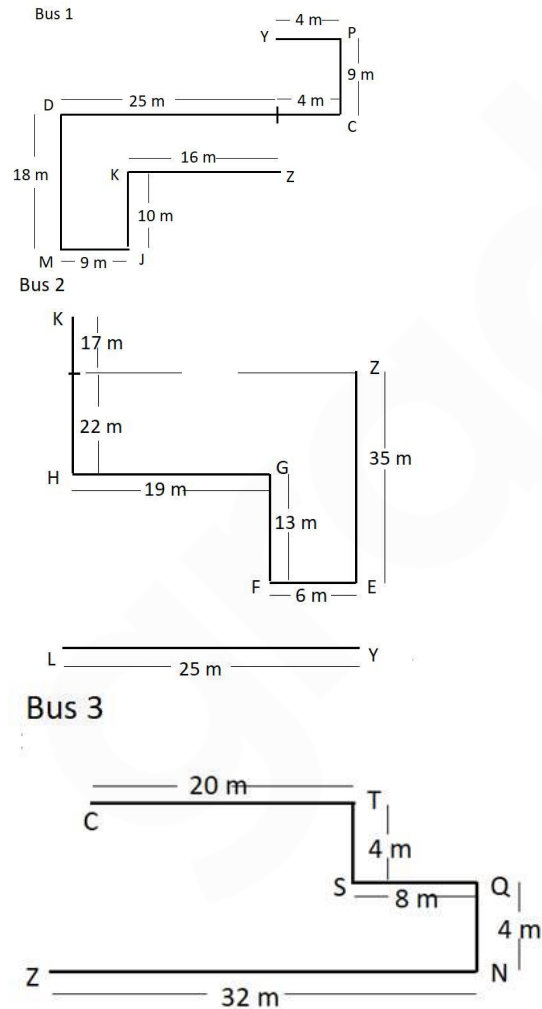

12. Ans. C.

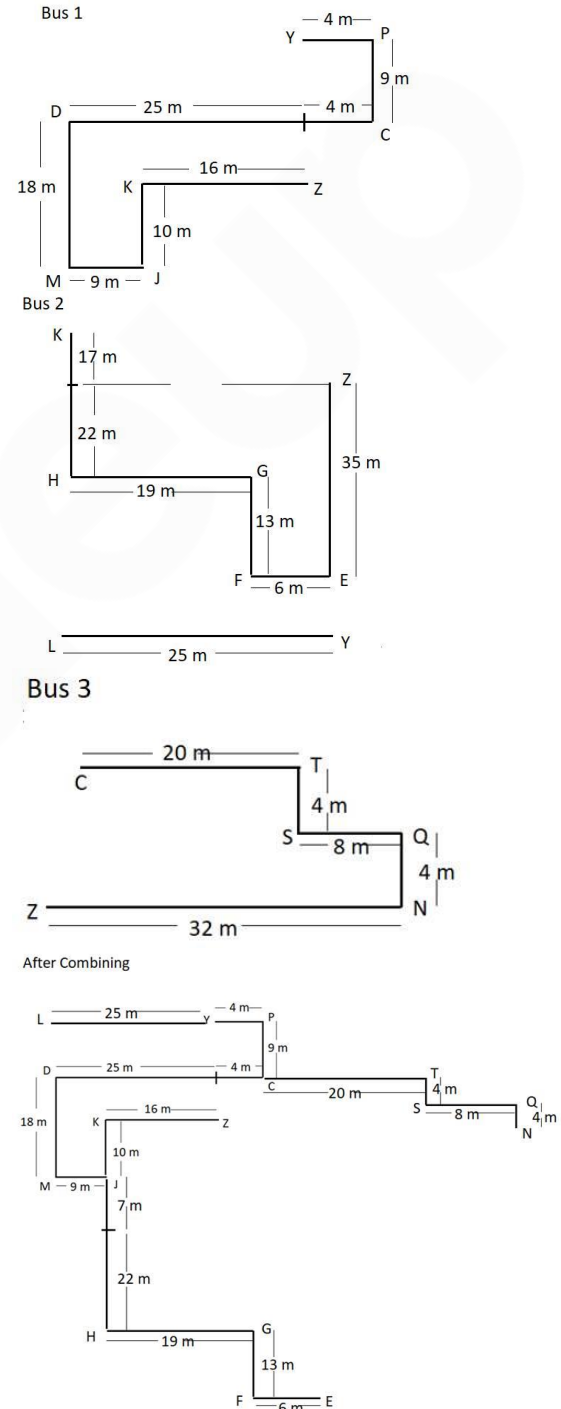

13. Ans. A.

Gradeup Green Card
 Unlimited Access to All 700+ Bank & Insurance Mock Tests

[CLICK HERE](#)

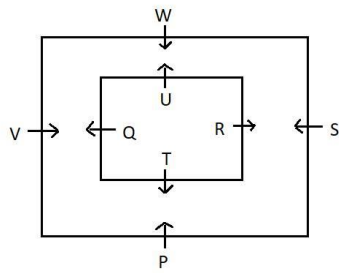

Couples: PT, RS, WU & VQ

14. Ans. C.

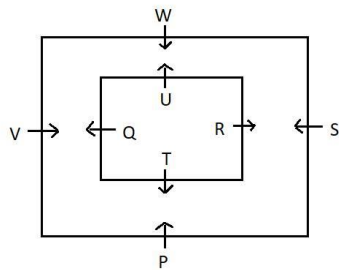

Couples: PT, RS, WU & VQ

15. Ans. A.

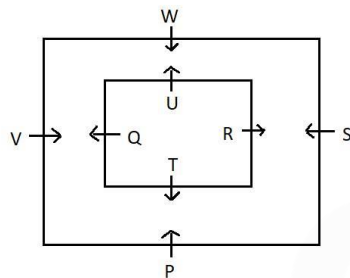

Couples: PT, RS, WU & VQ

16. Ans. B.

The correct answer is **option B**, i.e. **All I, II and III are implicit.**

An assumption is a thing that is accepted as true or as certain to happen, without proof.

From the statement, it is evident that it is about the PM-KISAN scheme which is entitled to small and medium farmers having cultivable land up to two hectares. The first installment as promised by the Prime Minister Narendra Modi will be processed on February 24.

Assumption (I) is a perfect assumption based on the information provided. The figure of 6000 is evident from the

information stated, 'first of the three installments of Rs 2,000 each'.

Assumption (II) is also appropriate. The idea of the scheme launched in this fiscal is evident from the fact that PM is launching it now and before March end the first transaction would be done. It also highlights the general idea behind the scheme to help the distressed farmers.

Similarly, assumption (III) is also appropriate as it follows the flow of the ideas stated and brings out the financial benefit the scheme will provide to the farmers.

Thus, all of the assumptions are relevant thus the most appropriate answer choice is option B.

17. Ans. A.

The correct answer is **option A**, i.e. **None is implicit.**

An assumption is a thing that is accepted as true or as certain to happen, without proof.

From the statement, it is evident the Indian authorities have allowed commercial operations to all the airports near the Jammu & Kashmir region and Dehradun that were shut after a few fighter jets of the Pakistani Air Force entered the Indian side of Kashmir. And further information regarding its components is also mentioned.

Assumption (I) can be rejected as the information stated in it is not backed by the context given.

Assumption (II) is not an apt assumption that can be made on the basis of the information provided. All the places mentioned for example Amritsar, Dharamshala are not evident from the given context.

Assumption (III) is rejected as it is contradictory to the information stated. It states that no NOTAM has been issued whereas the given information states that information has been sent to the authorities.

Thus, all of the assumptions are irrelevant and can be rejected and the most appropriate answer choice is option A

Gradeup Green Card

Unlimited Access to All 700+ Bank & Insurance Mock Tests

CLICK HERE

18. Ans. D.

The correct answer is **option D**, i.e. **None follows**.

A course of action is something that needs to be done considering the present scenario in mind.

From the statement, it is evident that it's about Maternity leave granted to the women employees as per the law and how the companies have been avoiding hiring female staff in order to avoid maternity leaves to them. Thus, a suitable course of action must be in the sense to avoid this injustice being done to women.

Course of action (I) can be rejected as it presents a course of action that is already stated by the government (past tense.. Moreover, it further presents the problem and does not present the solution to it and is thus rejected.

Course of action (II) is rejected as it simply presents facts and does not suggest any course of action.

Based on similar grounds, course of action (III) is also rejected. Course of action (III) also shows the views of the startups and the stats but it fails to provide a solution to the problem.

Thus, all the courses of actions are irrelevant and can be rejected.

19. Ans. C.

The box which contains orange is kept at either 8th or 10th position in the stack.

Two boxes are kept between the box which contains orange and Box A.

Number of boxes which contain fruits is same below and above the box which contains kiwi.

Case 1

	Box	Fruit
10		Orange
9		
8		
7	A	
6		Kiwi
5		
4		
3		
2		
1		

Case 2

	Box	Fruit
10		
9		
8		Orange
7		
6		Kiwi
5	A	
4		
3		
2		
1		

Number of boxes kept between box A and Box T is same as the number of boxes kept between box T and Box D.

Box A is above Box T but not immediately above.

The box which contains orange is not kept immediately above Box E.

Case 1 (A)

	Box	Fruit
10		Orange
9		
8		
7	A	
6		Kiwi
5	T	
4		
3	D	
2		
1		

Case 1 (B)

	Box	Fruit
10		Orange
9		
8		
7	A	
6		Kiwi
5		
4	T	
3		
2		
1	D	

Case 2

	Box	Fruit
10		
9		
8		Orange
7		
6		Kiwi
5	A	
4		
3	T	
2		
1	D	

Only three boxes are kept between box E and Box D where Box E is kept above box D.

(Hence, Case 1(A) and Case2 will get eliminated)

The box which contains apple is kept below Box T but not immediately below.

Box B contains apple.

The box which contains pear is kept above the box which contains litchi.

Box C is kept immediately above Box Q.

Neither box R nor box Q contains Pear.

Box R is kept above Box P but below Box S.

	Box	Fruit
10	C	Orange
9	Q	
8	S	Pear
7	A	
6	R	Kiwi
5	E	
4	T	Litchi
3	P	
2	B	Apple
1	D	

20. Ans. A.

The box which contains orange is kept at either 8th or 10th position in the stack.

Two boxes are kept between the box which contains orange and Box A.

Number of boxes which contain fruits is same below and above the box which contains kiwi.

Case 1

	Box	Fruit
10		Orange
9		
8		
7	A	
6		Kiwi
5		
4		
3		
2		
1		

Case 2

	Box	Fruit
10		
9		
8		Orange
7		
6		Kiwi
5	A	
4		
3		
2		
1		

Number of boxes kept between box A and Box T is same as the number of boxes kept between box T and Box D.

Box A is above Box T but not immediately above.

The box which contains orange is not kept immediately above Box E.

Case 1 (A)

	Box	Fruit
10		Orange
9		
8		
7	A	
6		Kiwi
5	T	
4		
3	D	
2		
1		

Case 1 (B)

	Box	Fruit
10		Orange
9		
8		
7	A	
6		Kiwi
5		
4	T	
3		
2		
1	D	

Case 2

	Box	Fruit
10		
9		
8		Orange
7		
6		Kiwi
5	A	
4		
3	T	
2		
1	D	

Only three boxes are kept between box E and Box D where Box E is kept above box D.

(Hence, Case 1(A) and Case2 will get eliminated)

The box which contains apple is kept below Box T but not immediately below.

Box B contains apple.

The box which contains pear is kept above the box which contains litchi.

Box C is kept immediately above Box Q. Neither box R nor box Q contains Pear. Box R is kept above Box P but below Box S.

	Box	Fruit
10	C	Orange
9	Q	
8	S	Pear
7	A	
6	R	Kiwi
5	E	
4	T	Litchi
3	P	
2	B	Apple
1	D	

21. Ans. D.

The box which contains orange is kept at either 8th or 10th position in the stack. Two boxes are kept between the box which contains orange and Box A. Number of boxes which contain fruits is same below and above the box which contains kiwi.

Case 1

	Box	Fruit
10		Orange
9		
8		
7	A	
6		Kiwi
5		
4		
3		
2		
1		

Case 2

	Box	Fruit
10		
9		
8		Orange
7		
6		Kiwi
5	A	
4		
3		
2		
1		

Number of boxes kept between box A and Box T is same as the number of boxes kept between box T and Box D. Box A is above Box T but not immediately above.

The box which contains orange is not kept immediately above Box E.

Case 1 (A)

	Box	Fruit
10		Orange
9		
8		
7	A	
6		Kiwi
5	T	
4		
3	D	
2		
1		

Case 1 (B)

	Box	Fruit
10		Orange
9		
8		
7	A	
6		Kiwi
5		
4	T	
3		
2		
1	D	

Case 2

	Box	Fruit
10		
9		
8		Orange
7		
6		Kiwi
5	A	
4		
3	T	
2		
1	D	

Only three boxes are kept between box E and Box D where Box E is kept above box D.

(Hence, Case 1(A) and Case2 will get eliminated)

The box which contains apple is kept below Box T but not immediately below. Box B contains apple.

The box which contains pear is kept above the box which contains litchi.

Box C is kept immediately above Box Q.

Neither box R nor box Q contains Pear.

Box R is kept above Box P but below Box S.

Gradeup Green Card

Unlimited Access to All 700+ Bank & Insurance Mock Tests

[CLICK HERE](#)

	Box	Fruit
10	C	Orange
9	Q	
8	S	Pear
7	A	
6	R	Kiwi
5	E	
4	T	Litchi
3	P	
2	B	Apple
1	D	

22. Ans. D.

The box which contains orange is kept at either 8th or 10th position in the stack.

Two boxes are kept between the box which contains orange and Box A.

Number of boxes which contain fruits is same below and above the box which contains kiwi.

Case 1

	Box	Fruit
10		Orange
9		
8		
7	A	
6		Kiwi
5		
4		
3		
2		
1		

Case 2

	Box	Fruit
10		
9		
8		Orange
7		
6		Kiwi
5	A	
4		
3		
2		
1		

Number of boxes kept between box A and Box T is same as the number of boxes kept between box T and Box D.

Box A is above Box T but not immediately above.

The box which contains orange is not kept immediately above Box E.

Case 1 (A)

	Box	Fruit
10		Orange
9		
8		
7	A	
6		Kiwi
5	T	
4		
3	D	
2		
1		

Case 1 (B)

	Box	Fruit
10		Orange
9		
8		
7	A	
6		Kiwi
5		
4	T	
3		
2		
1	D	

Case 2

	Box	Fruit
10		
9		
8		Orange
7		
6		Kiwi
5	A	
4		
3	T	
2		
1	D	

Only three boxes are kept between box E and Box D where Box E is kept above box D.

(Hence, Case 1(A) and Case2 will get eliminated)

The box which contains apple is kept below Box T but not immediately below. Box B contains apple.

The box which contains pear is kept above the box which contains litchi.

Box C is kept immediately above Box Q.

Neither box R nor box Q contains Pear.

Box R is kept above Box P but below Box S.

Gradeup Green Card

Unlimited Access to All 700+ Bank & Insurance Mock Tests

[CLICK HERE](#)

	Box	Fruit
10	C	Orange
9	Q	
8	S	Pear
7	A	
6	R	Kiwi
5	E	
4	T	Litchi
3	P	
2	B	Apple
1	D	

23. Ans. E.

As we can see that if we use any two there are so possibilities so we take all of them.

From I, II and III,

8	E
7	D
6	G
5	B
4	H
3	A
2	F
1	C

So C lives on 1st floor.

So all of them are necessary.

Hence, option E.

24. Ans. C.

C is standing in the middle of row-3

Detail Explanation:

As given that I, D and G are in three different rows. And the one who speaks Gujarati is in immediate left of the one who speaks Marathi. This raises two cases for row-1

Case-1 The one who speaks Marathi is in extreme right end.

_____, _____ Gujarati_____,
_____, _____ Marathi_____

Case-2 The one who speaks Marathi is in the middle of the Row.

_____, _____ Gujarati_____,
_____, _____ Marathi_____

Since H is standing in Row- at the right end and speaks a foreign language (i.e. English). Thus it eliminates the Case-1.

Case 2 is the only valid case.

ROW 1- _____ Gujarati_____,
_____ Marathi_____, _____ (H)
English_____.

Since in statement 9 it is mention that B is the only one who speaks Gujarati and is diagonally opposite to A. This can be valid only when A is at the right end of the Row-2. Thus A is the right end in the row-2...

Row-1 _____(B) _____ Gujarati_____,
_____ Marathi_____, _____(H)
English_____.

Row-2 _____, _____
_____, _____(A)_____.

The one who speaks Tamil in a row -2 is diagonally opposite to the one who speaks Telugu and Hindi in Row-3.

This raises 2 cases

Case-1

Row-1 _____ (B) _____ Gujarati_____,
_____ Marathi_____, _____ (H) English_____.

Row-2 _____, _____
_____ Tamil_____, _____ (A)
_____.

Row-3 _____ Telgu_____, _____,
_____ Hindi_____

Case-2

Row-1 _____ (B) _____ Gujarati_____,
_____ Marathi_____, _____ (H) English_____.

Row-2 _____, _____
_____ Tamil_____, _____ (A)
_____.

Row-3 _____ Hindi _____, _____,
_____ Telgu _____

According to statement 8 Case -2 is valid and Case-1 is invalid.

Thus

Row-1 _____ (B) _____ Gujarati_____,
_____ Marathi_____, _____ (H) English_____.

Row-2 _____, _____
_____ Tamil_____, _____ (A)
_____.

Row-3 _____ Hindi _____, _____,
_____ Telgu _____

Since there are 3 students who speak English and they are standing in different rows. Thus it implies A speaks English and the one who is in the center of Row-3 also speaks English.

Row-1 _____ (B) _____ Gujarati_____,
_____ Marathi_____, _____ (H) English_____.

Row-2 _____, _____
_____ Tamil_____, _____ English (A) _____.

Row-3 _____ Hindi _____,
 ___ English _____, _____ Telgu _____
 G speaks the language that is not spoken
 by any other student it implies he speaks
 Marathi.

I is in Row-2 and D is in Row-3 and
 speaks English. Thus, again two cases
 rise Either D speaks Hindi or Telugu. It is
 also stated That F is the right end of Row
 -3 Thus it is known that F speaks Telugu
 and he finds no difficulty while speaking
 to E, Implies both speak the same
 language. I am in row-2 and he speaks
 Tamil.

While the only left student is C who is the
 middle of the Row-3 and speaks English.

Final Arrangement -

Row-1	B (Gujarati)	G (Marathi)	H (English)
Row-2	E (Telugu)	I (Tamil)	A (English)
Row-3	D (Hindi)	C (English)	F (Telugu)

25. Ans. C.

A is the one in Row-2 who speaks English
 and his to his immediate right there is no
 one. While I is standing to his
 immediately Left. Thus I is the only
 immediate neighbor of A (who speaks
 English)

Detail Explanation:

As given that I, D and G are in three
 different rows. And the one who speaks
 Gujarati is in immediate left of the one
 who speaks Marathi. This raises two
 cases for row-1

Case-1 The one who speaks Marathi is in
 extreme right end.

_____, _____ Gujarati _____,
 _____ Marathi _____

Case-2 The one who speaks Marathi is in
 the middle of the Row.

_____ Gujarati _____,
 _____ Marathi _____,

Since H is standing in Row- at the right
 end and speaks a foreign language (i.e.
 English). Thus it eliminates the Case-1.

Case 2 is the only valid case.

ROW 1- _____ Gujarati _____,
 _____ Marathi _____, _____ (H)
 English _____.

Since in statement 9 it is mention that B
 is the only one who speaks Gujarati and
 is diagonally opposite to A. This can be
 valid only when A is at the right end of
 the Row-2. Thus A is the right end in the
 row-2...

Row-1 _____(B) _____ Gujarati____,
 _____Marathi_____, _____(H)
 English_____.

Row-2 _____, _____
 _____(A)_____.

The one who speaks Tamil in a row -2 is
 diagonally opposite to the one who
 speaks Telugu and Hindi in Row-3.

This raises 2 cases

Case-1

Row-1 _____ (B) _____ Gujarati____,
 _____Marathi_____, _____(H) English_____.

Row-2 _____,
 _____Tamil_____, _____ (A)
 _____.

Row-3 _____Telgu_____, _____,
 _____Hindi_____

Case-2

Row-1 _____ (B) _____ Gujarati____,
 _____Marathi_____, _____(H) English_____.

Row-2 _____,
 _____Tamil_____, _____ (A)
 _____.

Row-3 _____Hindi _____, _____,
 _____Telgu _____

According to statement 8 Case -2 is valid
 and Case-1 is invalid.

Thus

Row-1 _____ (B) _____ Gujarati____,
 _____Marathi_____, _____(H) English_____.

Row-2 _____Telgu_____,
 _____Tamil_____, _____ (A)
 _____.

Row-3 _____Hindi _____, _____,
 _____Telgu _____

Since there are 3 students who speak
 English and they are standing in different
 rows. Thus it implies A speaks English and
 the one who is in the center of Row-3 also
 speaks English.

Row-1 _____ (B) _____ Gujarati____,
 _____Marathi_____, _____(H) English_____.

Row-2 _____Telgu_____,
 _____Tamil_____, _____English (A) _____.

Row-3 _____Hindi _____,
 _____English_____, _____Telgu _____

Gradeup Green Card
 Unlimited Access to All 700+ Bank & Insurance
 Mock Tests

[CLICK HERE](#)

G speaks the language that is not spoken by any other student it implies he speaks Marathi.

I is in Row-2 and D is in Row-3 and speaks English. Thus, again two cases rise Either D speaks Hindi or Telugu. It is also stated That F is the right end of Row -3 Thus it is known that F speaks Telugu and he finds no difficulty while speaking to E, Implies both speak the same language. I am in row-2 and he speaks Tamil.

While the only left student is C who is the middle of the Row-3 and speaks English.

Final Arrangement -

Row-1	B (Gujarati)	G (Marathi)	H (English)
Row-2	E (Telugu)	I (Tamil)	A (English)
Row-3	D (Hindi)	C (English)	F (Telugu)

26. Ans. B.

C is the one is standing in Row-3, not in Row-2. Hence Option (b) C is the correct answer.

Detail Explanation:

As given that I, D and G are in three different rows. And the one who speaks Gujarati is in immediate left of the one who speaks Marathi. This raises two cases for row-1

Case-1 The one who speaks Marathi is in extreme right end.

_____, _____ Gujarati _____,
_____ Marathi _____

Case-2 The one who speaks Marathi is in the middle of the Row.

_____ Gujarati _____,
_____ Marathi _____,

Since H is standing in Row- at the right end and speaks a foreign language (i.e. English). Thus it eliminates the Case-1.

Case 2 is the only valid case.

ROW 1- _____ Gujarati _____,
_____ Marathi _____, _____ (H)
English _____.

Since in statement 9 it is mention that B is the only one who speaks Gujarati and is diagonally opposite to A. This can be valid only when A is at the right end of

the Row-2. Thus A is the right end in the row-2...

Row-1 _____ (B) Gujarati _____,
_____ Marathi _____, _____ (H)
English _____.

Row-2 _____, _____
_____, _____ (A) _____.

The one who speaks Tamil in a row -2 is diagonally opposite to the one who speaks Telugu and Hindi in Row-3.

This raises 2 cases

Case-1

Row-1 _____ (B) Gujarati _____,
_____ Marathi _____, _____ (H) English _____.

Row-2 _____
_____ Tamil _____, _____ (A)
_____.

Row-3 _____ Telgu _____, _____,
_____ Hindi _____

Case-2

Row-1 _____ (B) Gujarati _____,
_____ Marathi _____, _____ (H) English _____.

Row-2 _____
_____ Tamil _____, _____ (A)
_____.

Row-3 _____ Hindi _____, _____,
_____ Telgu _____

According to statement 8 Case -2 is valid and Case-1 is invalid.

Thus

Row-1 _____ (B) Gujarati _____,
_____ Marathi _____, _____ (H) English _____.

Row-2 _____ Telgu _____,
_____ Tamil _____, _____ (A)
_____.

Row-3 _____ Hindi _____, _____,
_____ Telgu _____

Since there are 3 students who speak English and they are standing in different rows. Thus it implies A speaks English and the one who is in the center of Row-3 also speaks English.

Row-1 _____ (B) Gujarati _____,
_____ Marathi _____, _____ (H) English _____.

Row-2 _____ Telgu _____,
_____ Tamil _____, _____ English (A) _____.

Row-3 _____ Hindi _____,
_____ English _____, _____ Telgu _____

G speaks the language that is not spoken by any other student it implies he speaks Marathi.

I is in Row-2 and D is in Row-3 and speaks English. Thus, again two cases

Gradeup Green Card

Unlimited Access to All 700+ Bank & Insurance Mock Tests

CLICK HERE

rise Either D speaks Hindi or Telugu. It is also stated That F is the right end of Row -3 Thus it is known that F speaks Telugu and he finds no difficulty while speaking to E, Implies both speak the same language. I am in row-2 and he speaks Tamil.

While the only left student is C who is the middle of the Row-3 and speaks English.

Final Arrangement -

Row-1	B (Gujarati)	G (Marathi)	H (English)
Row-2	E (Telugu)	I (Tamil)	A(English)
Row-3	D (Hindi)	C (English)	F (Telugu)

27. Ans. C.

H, A, and C are the one who speaks English. While D is the one who speaks Hindi. Thus D is the correct option who does not speak English.

Detail Explanation:

As given that I, D and G are in three different rows. And the one who speaks Gujarati is in immediate left of the one who speaks Marathi. This raises two cases for row-1

Case-1 The one who speaks Marathi is in extreme right end.

_____, _____ Gujarati _____,
_____ Marathi _____

Case-2 The one who speaks Marathi is in the middle of the Row.

_____ Gujarati _____,
_____ Marathi _____,

Since H is standing in Row- at the right end and speaks a foreign language (i.e. English). Thus it eliminates the Case-1.

Case 2 is the only valid case.

ROW 1- _____ Gujarati _____,
_____ Marathi _____, _____ (H)
English _____.

Since in statement 9 it is mention that B is the only one who speaks Gujarati and is diagonally opposite to A. This can be valid only when A is at the right end of the Row-2. Thus A is the right end in the row-2...

Row-1 _____(B) _____ Gujarati _____,
_____ Marathi _____, _____(H)
English _____.

Row-2 _____, _____
, _____(A) _____.

The one who speaks Tamil in a row -2 is diagonally opposite to the one who speaks Telugu and Hindi in Row-3.

This raises 2 cases

Case-1

Row-1 _____ (B) _____ Gujarati _____,
_____ Marathi _____, _____ (H) English _____.

Row-2 _____
_____ Tamil _____, _____ (A)
_____.

Row-3 _____ Telgu _____, _____,
_____ Hindi _____

Case-2

Row-1 _____ (B) _____ Gujarati _____,
_____ Marathi _____, _____ (H) English _____.

Row-2 _____
_____ Tamil _____, _____ (A)
_____.

Row-3 _____ Hindi _____, _____,
_____ Telgu _____

According to statement 8 Case -2 is valid and Case-1 is invalid.

Thus

Row-1 _____ (B) _____ Gujarati _____,
_____ Marathi _____, _____ (H) English _____.

Row-2 _____ Telgu _____,
_____ Tamil _____, _____ (A)
_____.

Row-3 _____ Hindi _____, _____,
_____ Telgu _____

Since there are 3 students who speak English and they are standing in different rows. Thus it implies A speaks English and the one who is in the center of Row-3 also speaks English.

Row-1 _____ (B) _____ Gujarati _____,
_____ Marathi _____, _____ (H) English _____.

Row-2 _____ Telgu _____,
_____ Tamil _____, _____ English (A) _____.

Row-3 _____ Hindi _____,
_____ English _____, _____ Telgu _____

G speaks the language that is not spoken by any other student it implies he speaks Marathi.

I is in Row-2 and D is in Row-3 and speaks English. Thus, again two cases rise Either D speaks Hindi or Telugu. It is also stated That F is the right end of Row -3 Thus it is known that F speaks Telugu and he finds no difficulty while speaking to E, Implies both speak the same

Gradeup Green Card

Unlimited Access to All 700+ Bank & Insurance Mock Tests

[CLICK HERE](#)

language. I am in row-2 and he speaks Tamil.

While the only left student is C who is the middle of the Row-3 and speaks English.

Final Arrangement -

Row-1	B (Gujarati)	G (Marathi)	H (English)
Row-2	E (Telugu)	I (Tamil)	A (English)
Row-3	D (Hindi)	C (English)	F (Telugu)

28. Ans. E.

The correct answer is option E, i.e. All of the above, i.e. all of the above are not an appropriate set of conclusions that can be derived from the information provided.

The given question asks which of the following is **not** an apt conclusion on the basis of the information provided thus we must look for any such information that cannot be derived from the passage stated.

Option A is not based on the passage as the role of 'local tribal assistants' is not mentioned in the given context.

Option B talks about a possibility (because of the word 'may') and is thus not a conclusion. Moreover, it poses a particular case of hornbills adapting to the environment if their requirements are fulfilled, which is not explicitly evident from the information provided.

Option C discusses the idea of hornbills using same nest over the years which is contradicting to the idea of adapting to a changed environment.

As all options A, B and C are irrelevant and are not based on the information provided thus, the most correct answer choice is option E.

29. Ans. D.

The correct answer is option D, i.e. Along with other threats such as hunting, modified land use, ensuing forest fragmentation, felling of large trees with the potential for nesting, the loss of fruit bearing trees could also affect hornbill nesting habits.

A course of action is something that needs to be done considering the present scenario in mind.

Option A is not a course of action and is a general statement about Hornbills. Thus, it is rejected.

Option B is in past tense ('highlighted') thus it is rejected.

Option C is an incomplete action, if considered because it does not answer to the question 'In addition to what?' and is also eliminated.

Both options D and E look appropriate course of actions. Between options D and E, option D is more appropriate. Option E talks about the idea of the 'same nest' and thus contradicts the idea that hornbills are adaptive to change. Thus, option E can also be rejected and as a result between options D and E, option D is relevant.

Thus, the most correct answer choice is option D and rest of the options can be rejected.

30. Ans. C.

The correct answer is **option 3, i.e. Mid-tier companies are sharpening their overall strategy, by increasing focus on certain markets and businesses than spread thin.**

'Inference' is a conclusion reached on the basis of evidence and reasoning.

We first make sure to read the statement carefully and then see what immediate inferences can be drawn based on our first reading. The next step is to look at the statements given in the options, analyze them and see if they seem relevant with respect to the information/data provided to us.

From the statement, we can infer that mid-tier IT companies are growing in terms of revenue with the advent of technology projects. Though, they are expected to outcast giants like Infosys and Wipro, the pressure on their margins is likely to increase.

(1) can be rejected as the 'indicators' mentioned in the beginning of the sentence are not mentioned anywhere in the given context. Also no information is evident regarding new logos.

(2) can also be rejected as no information is evident on the basis of the given context regarding expansion across geographies, verticals and service lines.

Gradeup Green Card
 Unlimited Access to All 700+ Bank & Insurance
 Mock Tests

CLICK HERE

(4) can be eliminated as it just a rephrase of the information already provided in the given statement.

From the given assumptions (3) is the most appropriate deduction that can be made.

(3) can be logically inferred on the basis of the fact that these companies are improving their strategy (which has impacted their revenue growth) by targeting certain markets and businesses (new technology projects).

As all the other options except (3) are irrelevant with respect to the data provided in the statement. Thus, the correct answer is option 3.

31. Ans. B.

The one who is heaviest among all sits third to the right of N, who is 60 years of age. The one who is 30yrs is the heaviest among all. Only one person sits between N and the one who is second heaviest among all, who is 14 years of age. Q is shorter than only two person. So, there will two possible case of sitting arrangement.

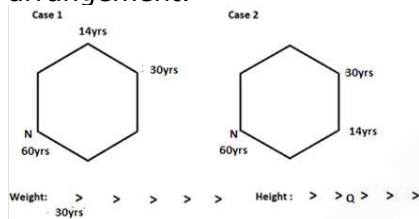

The one who is 35 years of age is second tallest, who sits second to the right of Q, who is not the immediate neighbour of N. O who is half the age of M. So M is 28 years of age and O is 14 years of age.

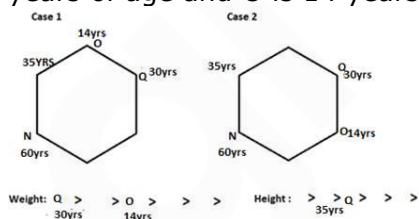

The one who sits opposite to R is the second heaviest among all. R sits second to the right P. **So, case 1 will be eliminated.** Continuing with remaining step, the one who is older than P is the taller than Q. The one who is twice the age of Q is third lightest among all. So, Q is 30 years of age.

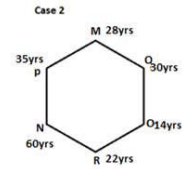

Weight: $Q > M > O > N > R > P$; Height: $N > P > Q > M > O > R$

M sits third to the right of the one who shortest in height among all. That means R is shortest of them all. M is taller than the one who is 14 years old.

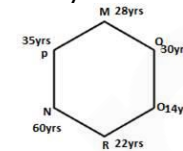

Weight: $Q > M > O > N > R > P$; Height: $N > P > Q > M > O > R$

32. Ans. C.

The one who is heaviest among all sits third to the right of N, who is 60 years of age. The one who is 30yrs is the heaviest among all. Only one person sits between N and the one who is second heaviest among all, who is 14 years of age. Q is shorter than only two person. So, there will two possible case of sitting arrangement.

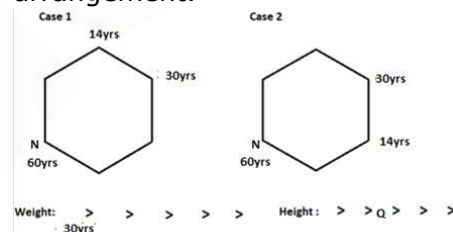

The one who is 35 years of age is second tallest, who sits second to the right of Q, who is not the immediate neighbour of N. O who is half the age of M. So M is 28 years of age and O is 14 years of age.

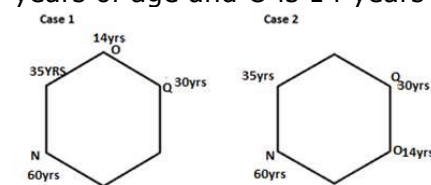

Weight: $Q > M > O > N > R > P$; Height: $N > P > Q > M > O > R$

The one who sits opposite to R is the second heaviest among all. R sits second to the right P. **So, case 1 will be eliminated.** Continuing with remaining step, the one who is older than P is the taller than Q. The one who is twice the

Gradeup Green Card
 Unlimited Access to All 700+ Bank & Insurance Mock Tests
[CLICK HERE](#)

age of Q is third lightest among all. So, Q is 30 years of age.

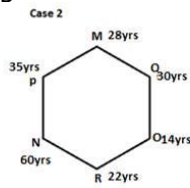

Weight: Q > M > O > N > > Height: N > P > Q > > >

M sits third to the right of the one who is shortest in height among all. That means R is shortest of them all. M is taller than the one who is 14 years old.

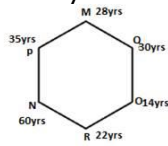

Weight: Q > M > O > N > R > P Height: N > P > Q > M > O > R

33. Ans. E.

All persons age are even number except option E person.

The one who is heaviest among all sits third to the right of N, who is 60 years of age. The one who is 30yrs is the heaviest among all. Only one person sits between N and the one who is second heaviest among all, who is 14 years of age. Q is shorter than only two person. So, there will two possible case of sitting arrangement.

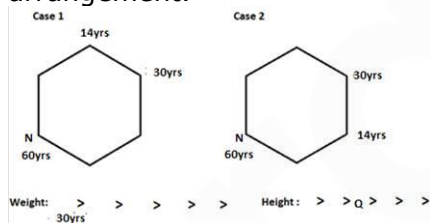

The one who is 35 years of age is second tallest, who sits second to the right of Q, who is not the immediate neighbour of N. O who is half the age of M. So M is 28 years of age and O is 14 years of age.

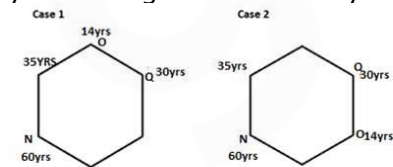

Weight: Q > > O > > > Height: > > Q > > >

The one who sits opposite to R is the second heaviest among all. R sits second to the right P. **So, case 1 will be eliminated.** Continuing with remaining

step, the one who is older than P is the taller than Q. The one who is twice the age of Q is third lightest among all. So, Q is 30 years of age.

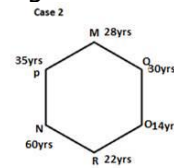

Weight: Q > M > O > N > > Height: N > P > Q > > >

M sits third to the right of the one who is shortest in height among all. That means R is shortest of them all. M is taller than the one who is 14 years old.

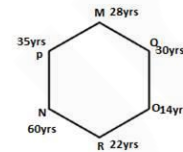

Weight: Q > M > O > N > R > P Height: N > P > Q > M > O > R

34. Ans. B.

The one who is heaviest among all sits third to the right of N, who is 60 years of age. The one who is 30yrs is the heaviest among all. Only one person sits between N and the one who is second heaviest among all, who is 14 years of age. Q is shorter than only two person. So, there will two possible case of sitting arrangement.

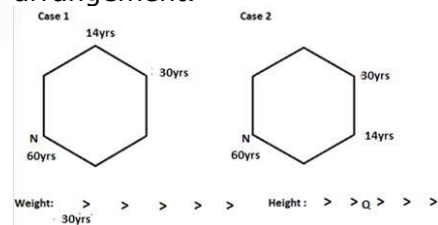

The one who is 35 years of age is second tallest, who sits second to the right of Q, who is not the immediate neighbour of N. O who is half the age of M. So M is 28 years of age and O is 14 years of age.

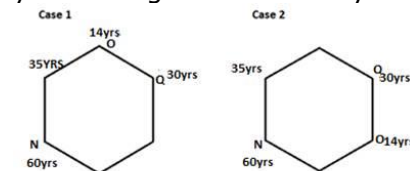

Weight: Q > > O > > > Height: > > Q > > >

The one who sits opposite to R is the second heaviest among all. R sits second to the right P. **So, case 1 will be eliminated.** Continuing with remaining

Gradeup Green Card
 Unlimited Access to All 700+ Bank & Insurance Mock Tests
[CLICK HERE](#)

step, the one who is older than P is the taller than Q. The one who is twice the age of Q is third lightest among all. So, Q is 30 years of age.

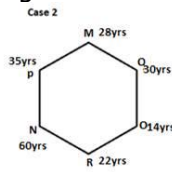

Weight: $Q > M > O > N > >$
30yrs 14yrs
 Height: $N > P > Q > >$
35yrs

M sits third to the right of the one who shortest in height among all. That means R is shortest of them all. M is taller than the one who is 14 years old.

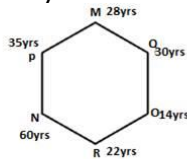

Weight: $Q > M > O > N > R > P$
30yrs 14yrs
 Height: $N > P > Q > M > O > R$
35yrs

35. Ans. C.

From statement I:

O got more salary than only two persons.
 $N > M$ but N did not get the highest salary. Q got highest salary than only R.

$P > N > M > O > Q > R$

From statement II:

M got less salary than only two persons.

$Q > R, O > Q, M > O, P > N$

$P > N > M > O > Q > R$

Hence, the data in statement I or in statement II alone is sufficient to answer the question.

36. Ans. C.

From this information their positions are in decreasing order-

$A(400) > B > C > D > E > F(60)$

It is given D, E and F have average marks = 95

So total marks = $95 \times 3 = 285$

F got 60 marks so-

$D + E = 285 - 60 = 225$ marks

37. Ans. D.

As the total time is 11 hours on adding all given times we will get bike serviced for 1 and half hour and Truck for 2 and half hours.

Jeep has to be serviced after Van and as per the given condition the first vehicle will be Bus followed by Bike, Truck, Van and Jeep and accordingly the following time is obtained

Vehicles	Servicing Time
Bus	07:00 am - 8 :30 am
Bike	08:30 am - 10:00 am
Truck	10:00 am - 12:30 pm
Van	12:30 pm - 03:00 pm
Jeep	03:00 pm - 06:00 pm

38. Ans. B.

As the total time is 11 hours on adding all given times we will get bike serviced for 1 and half hour and Truck for 2 and half hours.

Jeep has to be serviced after Van and as per the given condition the first vehicle will be Bus followed by Bike, Truck, Van and Jeep and accordingly the following time is obtained

Vehicles	Servicing Time
Bus	07:00 am - 8 :30 am
Bike	08:30 am - 10:00 am
Truck	10:00 am - 12:30 pm
Van	12:30 pm - 03:00 pm
Jeep	03:00 pm - 06:00 pm

39. Ans. D.

As the total time is 11 hours on adding all given times we will get bike serviced for 1 and half hour and Truck for 2 and half hours.

Jeep has to be serviced after Van and as per the given condition the first vehicle will be Bus followed by Bike, Truck, Van and Jeep and accordingly the following time is obtained

Vehicles	Servicing Time
Bus	07:00 am - 8 :30 am
Bike	08:30 am - 10:00 am
Truck	10:00 am - 12:30 pm
Van	12:30 pm - 03:00 pm
Jeep	03:00 pm - 06:00 pm

40. Ans. C.

The correct answer is **option 3**, i.e. **Only III is strong**.

We first make sure to read the statement carefully and then see what immediate inferences can be drawn based on our first reading. The next step is to look at the arguments given in the options, analyze them and see if they seem

Gradeup Green Card

Unlimited Access to All 700+ Bank & Insurance Mock Tests

[CLICK HERE](#)

relevant with respect to the information/data provided to us. Finally, it is very important to study the question closely.

The above statement deals with the fact that India has opted out from the deal with Russia and the latter has been conveyed that it can go ahead with the project and India may join it at a later stage.

Argument (I) can be rejected on first reading as it deals with the details of the deal and does not answers the question asked.

Argument (II) can also be rejected as it hints at the idea of the problems between the two nations. It might look as an appropriate answer choice but does not provides a suitable reason as to why India may be interested in the project in later stages (as mentioned in the statement).

Argument (III) generalizes the approach of India that it is adopting a layered approach and might be interested in the project later on. It captures the essence of the given statement and thus, answers the question in the complete manner.

Thus, option 3 captures the correct arguments that support the statement in the best possible manner and is our answer choice. Hence, rest of the options can be rejected.

41. Ans. A.

The correct answer is **option 1**, i.e. **In addition to rising delinquencies over the last few years would force lenders to be more cautious while underwriting loans. This would limit refinancing options, adversely affecting existing borrowers.**

Option 1 is the most appropriate inference that can be made based on the information provided. It captures all the important points like 'rising delinquencies', 'effect of limit on the refinancing options thereby, affecting the customers' are evident both from the given statement and the option choice.

Rest of the arguments can be rejected. Option (2) is very unpredictable and it cannot be said with surety about the loss limitation. Both options (3) and (4) can also be rejected as no idea of ABS (asset

backed securities) is evident from the information provided in the given statement.

Thus, the most appropriate answer is option 1.

42. Ans. A.

The correct answer is option A, i.e. Only conclusion I follows.

In this type of question, conclusion is not specifically mentioned. It needs to be deduced from the given statements.

From both the statements, we infer that the world's largest bee which is roughly the size of a human thumb has been rediscovered in a remote part of Indonesia. And despite of its conspicuous size, no one had observed Wallace's giant bee which was discovered in the 19th century by British naturalist Alfred Russel Wallace.

Conclusion 1 is evident from the information stated in the second statement which states that 'despite of its (bee's) conspicuous size, no one had observed Wallace's giant bee'. Thus, it can be concluded that previous expeditions failed to spot it.

Conclusion 2 is irrelevant as the idea of forests being cut down for agriculture in Indonesia is not supported by the information stated in the given context.

Conclusion 3 is also rejected as the specific location where the bee can be traced, and its large fang-like mandibles is not mentioned in both the statements. As only conclusion I follows the direction of the given statements thus, the most correct answer choice is option A and rest of the options can be rejected.

43. Ans. E.

1) Two persons sit between R and P.

Here, we have two possible cases i.e. Case 1 and Case 2.

2) P faces inside.

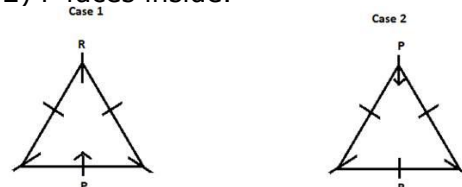

3) S sits second to the right of R.

Here, we have two more possible cases i.e. Case 3 and Case 4.

Gradeup Green Card
 Unlimited Access to All 700+ Bank & Insurance Mock Tests

[CLICK HERE](#)

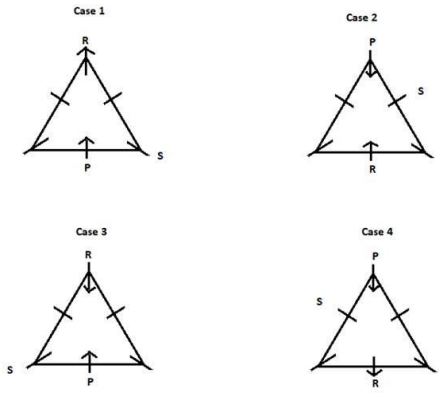

- 4) Only one person sits between N and S who does not sit at corner of the table. Here, our case 1 and 3 get eliminated and we further proceed with case 2 and 4.
- 5) L faces opposite direction to R.
- 6) M sits 2nd to the left of L.

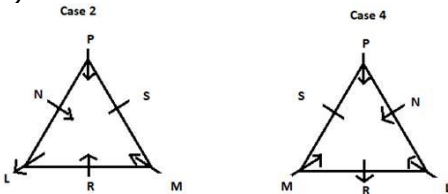

- 7) M and N faces same direction as P and not more than two persons sit adjacent to each other who are facing same direction. Here, Case 4 gets eliminated. So, S faces outside and our final arrangement will be:

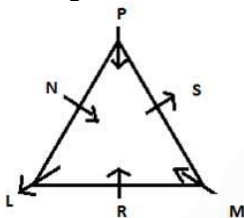

Clearly, L does not belong to that group because except L all are facing inside the table.

44. Ans. C.

- 1) Two persons sit between R and P. Here, we have two possible cases i.e. Case 1 and Case 2.
- 2) P faces inside.



- 3) S sits second to the right of R.

Here, we have two more possible cases i.e. Case 3 and Case 4.

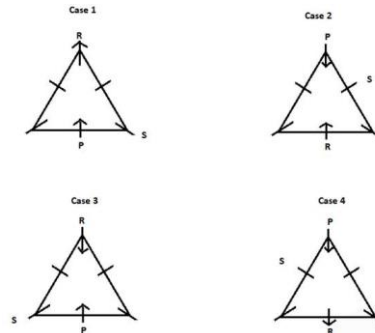

- 4) Only one person sits between N and S who does not sit at corner of the table. Here, our case 1 and 3 get eliminated and we further proceed with case 2 and 4.
- 5) L faces opposite direction to R.
- 6) M sits 2nd to the left of L.

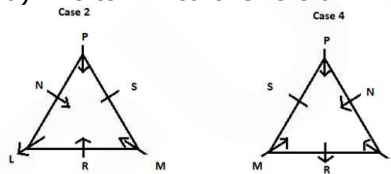

- 7) M and N faces same direction as P and not more than two persons sit adjacent to each other who are facing same direction. Here, Case 4 gets eliminated. So, S faces outside and our final arrangement will be:

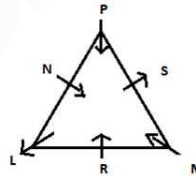

Clearly, P sits second to the right of the one who sits third to the left of N.

45. Ans. A.

- 1) Two persons sit between R and P. Here, we have two possible cases i.e. Case 1 and Case 2.
- 2) P faces inside.



- 3) S sits second to the right of R. Here, we have two more possible cases i.e. Case 3 and Case 4.

Gradeup Green Card
 Unlimited Access to All 700+ Bank & Insurance Mock Tests
[CLICK HERE](#)

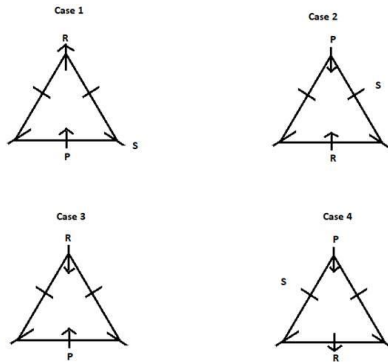

- 4) Only one person sits between N and S who does not sit at corner of the table. Here, our case 1 and 3 get eliminated and we further proceed with case 2 and 4.
 5) L faces opposite direction to R.
 6) M sits 2nd to the left of L.

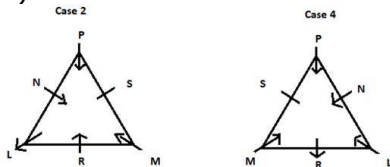

- 7) M and N faces same direction as P and not more than two persons sit adjacent to each other who are facing same direction. Here, Case 4 gets eliminated. So, S faces outside and our final arrangement will be:

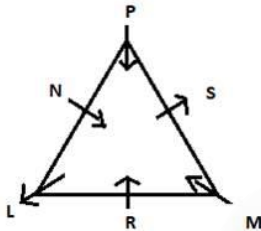

Clearly, three persons sit between S and N when counted from the right of N.
 46. Ans. B.

Pattern of the series I:

$$1 + 600 = 601$$

$$601 + 600/5 = 721 \quad (600/5 = 120)$$

$$721 + 120/4 = 751 \quad (120/4 = 30)$$

$$751 + 30/3 = 761 \quad (30/3 = 10)$$

$$761 + 10/5 = 766 \quad (10/2 = 5)$$

So, a = 761

Pattern of the series II:

$$753 + 16 = 769$$

$$769 - 8 = 761$$

$$761 + 4 = 765$$

$$765 - 2 = 763$$

$$763 + 1 = 764$$

So, b = 761

Pattern of the series III:

$$23 \times 1 + 1 = 24$$

$$24 \times 2 + 2 = 50$$

$$50 \times 3 + 3 = 153$$

$$153 \times 4 + 4 = 616$$

$$616 \times 5 + 5 = 3085$$

So, c = 616
 Hence, a = b > c

47. Ans. A.

Pattern of the series I (double difference):

$$107 - 5 = 102$$

$$117 - (5 + 5) = 107$$

$$134 - (5 + 5 + 7) = 117$$

$$134 - (5 + 5 + 7 + 9) = 160$$

So, a = 160

Pattern of the series II:

$$130 - 15 = 115$$

$$115 + 20 = 135$$

$$135 - 25 = 110$$

$$110 + 30 = 140$$

So, b = 140

Pattern of the series II:

$$160 \times 0.5 = 80$$

$$80 \times 1.5 = 120$$

$$120 \times 2.5 = 300$$

$$300 \times 3.5 = 1050$$

So, c = 160

Hence, b < a = c.

48. Ans. C.

Village	Density	Area (in sq. km)	Population (Density × Area)
A	300	20	6000
B	400	5	2000
C	500	8	4000
D	800	12	9600

Let the female population in village A and C be F

Population of male in village A = (6000 - F)

Population of male in village C = (4000 - F)

According to the question:

$$\frac{(4000 - F)}{F} \times 100 + 125 = \frac{(6000 - F)}{F} \times 100$$

On solving above equation, we get F = 1600

Hence, male population in village A = 6000 - 1600 = 4400

49. Ans. E.

Gradeup Green Card
 Unlimited Access to All 700+ Bank & Insurance Mock Tests
[CLICK HERE](#)

Village	Density	Area (in sq. km)	Population (Density × Area)
A	300	20	6000
B	400	5	2000
C	500	8	4000
D	800	12	9600

Population of village D = 9600
 Male population of village D = 9600 - 4000 = 5600

Gender ratio of village D = $\frac{5600}{4000} \times 100 = 140$

50. Ans. A.
 Population density of village B in 2001 = 400

Then, population density of village E in 2001 = 1600 (since, ratio of population density of a village B to that of village E is 1 : 4)

Population density of village E in 2010 = 800 (50% of 1600)
 Population of village E in 2010 = 800 × 4 = 3200

51. Ans. D.
 Total number of people shown interest for a loan = 9600
 Total number of people who have applied for loan = 37.5% of 9600

$\frac{75}{100} \times 9600 = 20 \times 9600 = 3600$
 Since, 2880 were not eligible for a loan,
 So, total no. of people eligible for loan = 3600 - 2880 = 720

52. Ans. E.
 Total number of people shown interest for a loan = 9600
 Total number of people visited for a loan fair = 9600 + 6000 = 15,600
 Total number of people contacted for a loan fair = 15,600 + 7400 = 23,000.

53. Ans. C.
 Total number of people contacted for loan fair = z

Here, z is given as 19200
 Total number of people visited for the loan fair = x

Total number of people who have shown interest for the loan fair = 9600
 Total number of people who did not visit for the loan fair = z - x or, 19200 - x
 Total number of people who visited but did shown interest loan = x - 9600

Now, according to the question = $\frac{19200-x}{x-9600} = \frac{7}{5}$

$$\Rightarrow x = 14,400$$

54. Ans. E.
 Total number of people eligible for loan = 20% of 37.5% of 9600

$\frac{20}{100} \times \frac{75}{100} \times 9600 = 720$
 Loan of 40% of the people did not disbursed who were eligible for a loan = 40% of 720

$\frac{40}{100} \times 720 = 288$
 Total number of people whose loan disbursed = 720 - 288 = 432

Hence, required ratio = $\frac{432}{9600} = \frac{600}{600} = 27$

55. Ans. E.
 Total number of people eligible for loan = 20% of 37.5% of 9600

$\frac{20}{100} \times \frac{75}{100} \times 9600 = 720$
 Total number of people who shown interest but did not apply for loan = 62.5% of 9600

$\frac{625}{1000} \times 9600 = 6000$
 Now, 9% of 6000 = 540 = whose loans were not disbursed

So, people whose loans were disbursed = 720 - 540 = 180
 Hence, value of y = 180

56. Ans. C.
 Total area of pie = (X × 0.77) cm²
 50% was rotten, therefore, the area of remaining 50% = (X - 3) × 0.616 cm²
 So, (X - 3) × 0.616 cm² × 2 = (X × 0.77) cm²

$$\Rightarrow (1.232 - 0.77)X = 3.696$$

$\frac{3.696}{0.462} = 8$
 57. Ans. E.
 Area of original pie = 8 × 0.77 cm²
 $\pi r^2 = 8 \times 0.77 \text{ cm}^2$

$\Rightarrow r = \sqrt{\frac{6.16}{3.14}} = 1.4 \text{ cm}$
 hence, the circumference of the original pie = 2πr = 2 × 3.14 × 1.4 = 8.792 cm

58. Ans. B.

Gradeup Green Card
 Unlimited Access to All 700+ Bank & Insurance Mock Tests

CLICK HERE

Area of original pie = $8 \times 0.77 \text{ cm}^2 = 6.16 \text{ cm}^2$

Pie is cut into 11 pieces

So, area of each piece = $\frac{6.16}{11} = 0.56 \text{ cm}^2$
59. Ans. C.

Work unit of project A in both situation 1 and situation 2 are same.

$$X \times 88 = (X + 8) \times 66$$

$$\Rightarrow 8X - 6X = 48$$

$$\Rightarrow X = 24$$

Now, According to question:

$$24 \times 88 = 64 \times \text{Required number of days}$$

$$\text{Hence, required number of days} = \frac{24 \times 88}{64}$$

$$= 33 \text{ days}$$

60. Ans. C.

Work unit of project C in both situation 1 and situation 2 are same.

$$\Rightarrow Z^2 \times 75 = M^2 \times 108$$

$$\Rightarrow \frac{Z^2}{M^2} = \frac{108}{75} = \frac{36}{25} = \frac{6^2}{5^2}$$

$$\Rightarrow \frac{Z}{M} = \frac{6}{5}$$

$$\text{Total unit work of project C} = 36 \times 75 = 2700$$

$$\text{Days required by Team P to complete} = \frac{2700}{30} = 90 \text{ days}$$

$$\text{Project C} = (0.5Z \times 2M) = \frac{2700}{30} = 90 \text{ days}$$

61. Ans. B.

Work unit of project B in both situation 1 and situation 2 are same.

$$\Rightarrow Y(Y - 1) = (Y + 6)(Y - 6)$$

$$\Rightarrow Y^2 - Y = Y^2 - 36$$

$$\Rightarrow Y = 36$$

$$\text{So, total work units} = 36 \times 35 = 1260$$

According to the question:

$$0.5Y \times 10 + (0.5Y + 0.5Y) \times D = 1260$$

$$\Rightarrow 5Y + YD = 1260$$

$$\Rightarrow YD = 1260 - 180$$

$$\Rightarrow D = 1080/36$$

$$\Rightarrow D = 30$$

$$\text{Total days in which work completed} = 30 + 10 = 40 \text{ days}$$

62. Ans. D.

Let the number of white balls = w, the number of green balls = g and the number of red balls = r, then

$$\frac{w}{w + g + r} = \frac{1}{3}$$

$$\Rightarrow (g + r) = 2w$$

$$\Rightarrow g = (2w - r)$$

According to question

$$\frac{g}{(w + g + r)} - \frac{g}{(w + g + r + 6)} = \frac{1}{30}$$

$$\frac{6g}{(w + g + r)(w + g + r + 6)} = \frac{1}{30}$$

$$\frac{6g}{3w \times (3w + 6)} = \frac{1}{30}$$

$$\Rightarrow 20g = w(w + 2)$$

$$\Rightarrow 20(2w - r) = w(w + 2)$$

$$\text{Let } r = 7x, \text{ then } w = 5x$$

$$\Rightarrow 20(10x - 7x) = 5x(5x + 2)$$

$$\Rightarrow 12 = (5x + 2)$$

$$\Rightarrow x = 2$$

$$\text{So, number of red balls} = 7x = 14,$$

$$\text{number of white balls} = 5x = 10 \text{ and}$$

$$\text{number of green balls} = (2w - r) = 6$$

Hence, the required probability =

$$\frac{{}^{14}C_1 \times {}^{10}C_1}{{}^{30}C_2} = \frac{14 \times 10}{15 \times 29} = \frac{28}{87}$$

63. Ans. A.

Let the number of white balls = w, the number of green balls = g and the number of red balls = r, then

$$\frac{w}{w + g + r} = \frac{1}{3}$$

$$\Rightarrow \frac{w}{30} = \frac{1}{3}$$

$$\Rightarrow w = 10$$

$$\text{Hence, the required probability} = \frac{{}^{10}C_2}{{}^{30}C_2} = \frac{10 \times 9}{30 \times 29} = \frac{3}{29}$$

64. Ans. C.

Let the number of white balls = w, the number of green balls = g and the number of red balls = r, then

$$\frac{w}{w + g + r} = \frac{1}{3}$$

$$\Rightarrow (w + g + r) = 3w$$

According to question

$$\frac{g}{(w + g + r)} = \frac{1}{5}$$

$$\Rightarrow (w + g + r) = 5g$$

$$\text{Let } (w + g + r) = 15x, \text{ then}$$

$$w = 5x, g = 3x \text{ and } r = 15x - 5x - 3x = 7x$$

Also given

$$\frac{3x}{15x - (15x + 6)} = \frac{1}{30}$$

$$\Rightarrow \frac{3x}{15x+6} = \frac{1}{6}$$

$$\Rightarrow x = 2$$

So, number of red balls = $r = 7x = 14$,
number of white balls = $w = 5x = 10$ and
number of green balls = $g = 3x = 6$

Hence, the required probability = $\frac{(10+6)C_2}{30C_2} = \frac{16 \times 15}{30 \times 29} = \frac{8}{29}$.

65. Ans. B.

Let the number of white balls = w , the
number of green balls = g and the
number of red balls = r , then $g + w = 16$

Given $\frac{w}{(w+g+r)} = \frac{1}{3}$

$$\Rightarrow w = \frac{(16+r)}{3}$$

$$\Rightarrow g = 16 - w = 16 - \frac{(16+r)}{3} = \frac{(32-r)}{3}$$

According to question

$$\Rightarrow \frac{g}{(w+g+r)} = \frac{g}{(w+g+r+6)} = \frac{1}{3}$$

$$\Rightarrow \frac{2(32-r)}{(w+g+r)(w+g+r+6)} = \frac{1}{3}$$

$$\Rightarrow \frac{2(32-r)}{(16+r)(22+r)} = \frac{1}{3}$$

$$\Rightarrow r^2 + 98r - 2272 = 0$$

$$\Rightarrow r^2 + 112r - 14r - 2272 = 0$$

$$\Rightarrow r = 14 \text{ or } -112$$

$$\text{So, } g = \frac{(32-r)}{3} = \frac{(32-14)}{3} = 6 \text{ and } w = 16 - g = 10$$

Hence, the required probability = $\frac{14C_2}{30C_2} + \frac{6C_2}{30C_2}$

$$= \frac{10 \times 9}{30 \times 29} + \frac{182 + 30 + 90}{30 \times 29} = \frac{151}{435}$$

$$= \frac{10 \times 9}{30 \times 29} + \frac{182 + 30 + 90}{30 \times 29} = \frac{151}{435}$$

66. Ans. C.

Let the total number of balls in the bag = $(3 \times 5)x = 15x$, then

Number of white balls = $15x \times \frac{3}{5} = 9x$ and
sum of the number of white and red balls

$$= 15x \times \frac{4}{5} = 12x, \text{ then}$$

Number of red balls = $12x - 9x = 3x$ and
number of green balls = $15x - 12x = 3x$

Also,

$$\frac{3x}{15x - (15x+6)} = \frac{1}{30}$$

$$\Rightarrow \frac{3x}{15x+6} = \frac{1}{6}$$

$$\Rightarrow x = 2$$

So, number of red balls = $7x = 14$ and
number of white balls = $5x = 10$

Hence, the required number of balls = $14 + 10 = 24$.

67. Ans. E.

Given, (Son's present age - 3 years) +
(Daughter's present age - 3 years) + 4
years = (Amit's present age - 3 years)
 \Rightarrow Son's present age + Daughter's present
age = (Amit's present age - 1 year)

From statement III: (Son's present age
+ 2 years) + (Daughter's present age +
2 years) - 1 year = (Amit's present age
+ 2 years)

\Rightarrow Son's present age + Daughter's present
age = (Amit's present age - 1 year)

This information is already given in
question, so we cannot answer the
question from statement III.

\Rightarrow

From statement I: Wife's present age =
Amit's present age - 7 years

Wife's present age = $2 \times$ Amit's son
present age

Also, Amit's present age = Wife's present
age + 7 years = $2 \times$ Son's present age +
7

\Rightarrow Son's present age + Daughter's present
age = $(2 \times$ Son's present age + 6 years)

\Rightarrow Daughter's present age = (Son's
present age + 6 years)

From statement II: Let 4 years hence
the age of Amit's daughter = $6x$ years,
then

4 years hence the age of Amit's son = $5x$
years

3 years ago, the age of Amit = $(6x - 4 -$
 $3) + (5x - 4 - 3) + 4 = (11x - 10)$ years

Present age of Amit = $(11x - 10) + 3 =$
 $(11x - 7)$ years

From statements I and II together:

$$6x - 4 = 5x - 4 + 6$$

$$\Rightarrow x = 6$$

Hence, statements I and II together
sufficient to answer the question.

68. Ans. D.

Total profit at the end of the year = 40% of (60000 + 45000) = Rs. 42000
Hence, the share of A in the total profit = $\frac{60000 \times 12}{(60000 \times 12) + (45000 \times 9)} \times 42000 = \text{Rs. } 26880.$

69. Ans. C.

Let the number of long questions answered by B and C be y and z respectively, then

the number of short questions answered by B = 5y

Number of spelling errors made by A = (2x + 10), then

$$\frac{3(2x + 10)}{8} = \frac{3(x + 5)}{4}$$

For C, number of short questions answered = (Number of long questions answered by B × 10 + 35)/5

$$= (2z + 7)$$

Number of short questions answered by D is average of that answered by A and B

$$= \frac{(x + 6) + 5y}{2} = \frac{(x + 5y + 6)}{2}$$

Number of long questions answered by D

$$= \frac{20\%}{\frac{80\%}{\text{Number of short questions answered by D}}}$$

⇒ Number of long questions answered by D = $\frac{20\%}{80\%} \times \text{Number of short questions answered by D}$

Number of short questions answered by D

$$= \frac{(x + 5y + 6)}{4} \times 4 = 8$$

Number of spelling errors made by D = (4 × 10) - $\frac{4}{16(x + 5)}$ = (20 - 4x)

Student	No. of short question answered	No. of long question answered	No. of spelling error	Total marks
A	(x + 6)	x	(2x + 10)	(14x + 25)
B	5y	Y	3(x + 5)/4	102
C	(2z + 7)	Z	5(x + 5)/4	
D	(x + 5y + 6)/2	(x + 5y + 6)/8	(20 - 4x)	86

Total marks scored by D = 86

$$5(x + 5y + 6)/2 + 10(x + 5y + 6)/8 - (20 - 4x)/2 = 86$$

$$\Rightarrow 15(x + 5y + 6)/4 - (10 - 2x) = 86$$

$$\Rightarrow 23x + 75y = 294 \dots (i)$$

$$\text{Also, } 5 \times 5y + 10 \times y - 3(x + 5)/8 = 102$$

$$\Rightarrow 280y - 3x = 831 \dots (ii)$$

On solving equation (i) and (ii), we get

$$x = y = 3$$

∴ The number of question short and long questions answered, number of spelling errors and total marks scored will be as follow

Student	No. of short question answered	No. of long question answered	No. of spelling error	Total marks
A	9	3	16	67
B	15	3	6	102
C	(2z + 7)	Z	10	
D	12	3	8	86

Required difference = 102 - 67 = 35.

70. Ans. A. A. A. A. A. A. A. A.

71. Ans. C.

Let the number of long questions answered by B and C be y and z respectively, then

the number of short questions answered by B = 5y

Number of spelling errors made by A = (2x + 10), then

$$\frac{3(2x + 10)}{8} = \frac{3(x + 5)}{4}$$

For C, number of short questions answered = (Number of long questions answered by B × 10 + 35)/5

$$= (2z + 7)$$

Number of short questions answered by D is average of that answered by A and B

$$= \frac{(x + 6) + 5y}{2} = \frac{(x + 5y + 6)}{2}$$

Number of long questions answered by D

$$= \frac{20\%}{\frac{80\%}{\text{Number of short questions answered by D}}}$$

Number of short questions answered by D

⇒ Number of long questions answered by D = $\frac{20\%}{80\%} \times \text{Number of short questions answered by D}$

Number of short questions answered by D

$$= \frac{(x + 5y + 6)}{4} \times 4 = 8$$

Number of spelling errors made by D = (4 × 10) - $\frac{4}{16(x + 5)}$ = (20 - 4x)

$$\times 10) - \frac{4}{16(x + 5)} = (20 - 4x)$$

Student	No. of short question answered	No. of long question answered	No. of spelling error	Total marks
A	(x + 6)	x	(2x + 10)	(14x + 25)
B	5y	Y	3(x + 5)/4	102
C	(2z + 7)	Z	5(x + 5)/4	
D	(x + 5y + 6)/2	(x + 5y + 6)/8	(20 - 4x)	86

Total marks scored by D = 86

$$5(x + 5y + 6)/2 + 10(x + 5y + 6)/8 - (20 - 4x)/2 = 86$$

$$\Rightarrow 15(x + 5y + 6)/4 - (10 - 2x) = 86$$

$$\Rightarrow 23x + 75y = 294 \dots (i)$$

Also, $5 \times 5y + 10 \times y - 3(x + 5)/8 = 102$
 $\Rightarrow 280y - 3x = 831 \dots (ii)$

On solving equation (i) and (ii), we get
 $x = y = 3$

\therefore The number of question short and long questions answered, number of spelling errors and total marks scored will be as follow

Student	No. of short question answered	No. of long question answered	No. of spelling error	Total marks
A	9	3	16	67
B	15	3	6	102
C	(2z + 7)	Z	10	
D	12	3	8	86

Required ratio = $(15 + 3) : (12 + 3) = 6 : 5$.

72. Ans. D.

Let the number of long questions answered by B and C be y and z respectively, then

the number of short questions answered by B = 5y

Number of spelling errors made by A = $(2x + 10)$, then

$$\frac{\text{Number of spelling errors made by B}}{8} = \frac{3(2x + 10)}{4} = \frac{3(x + 5)}{4}$$

For C, number of short questions answered = $(\text{Number of long questions answered by B} \times 10 + 35)/5$
 $= (2z + 7)$

Number of short questions answered by D is average of that answered by A and B

$$\frac{(x + 6) + 5y}{2} = \frac{(x + 5y + 6)}{2}$$

Number of long questions answered by D

$$\frac{20\%}{\text{Number of short questions answered by D}} = \frac{80\%}{\text{Number of long questions answered by D}}$$

\Rightarrow Number of long questions answered by D

Number of short questions answered by D

$$\frac{(x + 5y + 6)}{4} = 8$$

Number of spelling errors made by D = $(4 \times 10) - \frac{16(x + 5)}{4} = (20 - 4x)$

Student	No. of short question answered	No. of long question answered	No. of spelling error	Total marks
A	(x + 6)	x	(2x + 10)	(14x + 25)
B	5y	Y	3(x + 5)/4	102
C	(2z + 7)	Z	5(x + 5)/4	
D	(x + 5y + 6)/2	(x + 5y + 6)/8	(20 - 4x)	86

Total marks scored by D = 86

$5(x + 5y + 6)/2 + 10(x + 5y + 6)/8 - (20 - 4x)/2 = 86$

$\Rightarrow 15(x + 5y + 6)/4 - (10 - 2x) = 86$

$\Rightarrow 23x + 75y = 294 \dots (i)$

Also, $5 \times 5y + 10 \times y - 3(x + 5)/8 = 102$
 $\Rightarrow 280y - 3x = 831 \dots (ii)$

On solving equation (i) and (ii), we get
 $x = y = 3$

\therefore The number of question short and long questions answered, number of spelling errors and total marks scored will be as follow

Student	No. of short question answered	No. of long question answered	No. of spelling error	Total marks
A	9	3	16	67
B	15	3	6	102
C	(2z + 7)	Z	10	
D	12	3	8	86

It is given that

Total marks of A < Total marks of C < Total marks of D

$68 < [5(2z + 7) + 10z - 5] < 86$

$\Rightarrow 68 < (20z + 30) < 86$

$\Rightarrow 38 < 20z < 56$

\therefore Possible value of z = 2

So, total marks scored by C = $(20z + 30) = 70$

Total marks scored by E = Total marks scored by C + 30 = $70 + 30 = 100$

Hence, the required percentage = $\frac{100 - 70}{100} \times 100 = 30\%$.

73. Ans. C.

Let the number of long questions answered by B and C be y and z respectively, then

the number of short questions answered by B = 5y

Number of spelling errors made by A = $(2x + 10)$, then

$$\frac{\text{Number of spelling errors made by B}}{8} = \frac{3(2x + 10)}{4} = \frac{3(x + 5)}{4}$$

For C, number of short questions answered = $(\text{Number of long questions answered by B} \times 10 + 35)/5$
 $= (2z + 7)$

Number of short questions answered by D is average of that answered by A and B

$$\frac{(x + 6) + 5y}{2} = \frac{(x + 5y + 6)}{2}$$

$$= 2 = 2$$

Gradeup Green Card

Unlimited Access to All 700+ Bank & Insurance Mock Tests

[CLICK HERE](#)

$$\frac{\text{Number of long questions answered by D}}{\text{Number of short questions answered by D}} = \frac{20\%}{80\%}$$

$$\Rightarrow \frac{\text{Number of long questions answered by D}}{\text{Number of short questions answered by D}} = \frac{1}{4}$$

$$\frac{(x + 5y + 6)}{4} = \frac{8}{16(x + 5)}$$

$$\times 10) - \frac{4}{16(x + 5)} = (20 - 4x)$$

Student	No. of short question answered	No. of long question answered	No. of spelling error	Total marks
A	(x + 6)	x	(2x + 10)	(14x + 25)
B	5y	Y	3(x + 5)/4	102
C	(2z + 7)	Z	5(x + 5)/4	
D	(x + 5y + 6)/2	(x + 5y + 6)/8	(20 - 4x)	86

Total marks scored by D = 86
 $5(x + 5y + 6)/2 + 10(x + 5y + 6)/8 - (20 - 4x)/2 = 86$
 $\Rightarrow 15(x + 5y + 6)/4 - (10 - 2x) = 86$
 $\Rightarrow 23x + 75y = 294 \dots (i)$
 Also, $5 \times 5y + 10 \times y - 3(x + 5)/8 = 102$
 $\Rightarrow 280y - 3x = 831 \dots (ii)$
 On solving equation (i) and (ii), we get
 $x = y = 3$

∴ The number of question short and long questions answered, number of spelling errors and total marks scored will be as follow

Student	No. of short question answered	No. of long question answered	No. of spelling error	Total marks
A	9	3	16	67
B	15	3	6	102
C	(2z + 7)	Z	10	
D	12	3	8	86

Required sum = 3 + 3 + 3 = 9.

74. Ans. C.

	Open	High	Low	Close
Monday	60	66	40	52
Tuesday	40	60	42	50
Wednesday	55	70	30	45
Thursday	45	50	40	40
Friday	35	54	32	48

Hence, the required ratio = (66 + 60 + 70 + 54) : (40 + 42 + 30 + 38) = 250 : 150 = 5 : 3.

75. Ans. B.

	Open	High	Low	Close
Monday	60	66	40	52
Tuesday	40	60	42	50
Wednesday	55	70	30	45
Thursday	45	50	40	40
Friday	35	54	32	48

Total cost price of shares = 150 × 40 = Rs. 6000

Total commission while buying = Rs. 200
 Total selling price = 40% of 150 × 50 + 60% of 150 × 35 = 3000 + 3150 = Rs. 6150

Total commission while selling = 8% of 6150 = Rs. 492

Hence, the total loss incurred by trader = 6000 + 200 + 492 - 6150 = Rs. 542.

76. Ans. D.

	Open	High	Low	Close
Monday	60	66	40	52
Tuesday	40	60	42	50
Wednesday	55	70	30	45
Thursday	45	50	40	40
Friday	35	54	32	48

Selling amount of shares on Friday = $0.8X \times 35 = Rs. 9$

Total commission while selling on Friday = $10\% \text{ of } (9 - 3000) = (9 - 200)$

According to question
 $9 - (9 - 200) = 5240$
 $126X = 5040$
 $X = 360$

77. Ans. A.

	Open	High	Low	Close
Monday	60	66	40	52
Tuesday	40	60	42	50
Wednesday	55	70	30	45
Thursday	45	50	40	40
Friday	35	54	32	48

Let he bought the shares at the price Rs.x/share, then

Total cost price for shares = 250 × x = Rs. 250x (It must be greater than Rs. 5000, because x ≥ 40)

Total commission while buying = Rs. 250 + 5% of (250x - 5000) = Rs. 12.5x

Gradeup Green Card
 Unlimited Access to All 700+ Bank & Insurance Mock Tests
[CLICK HERE](#)

Total selling price = $\frac{3}{5}$ of $250 \times 50 + \frac{2}{5}$ of $250 \times 70 = 7500 + 7000 = \text{Rs. } 14500$
 Total commission while selling = $[100 + 8\% \text{ of } (7500 - 4000)] + [100 + 8\% \text{ of } (7000 - 4000)] = 200 + 8\% \text{ of } 6500 = \text{Rs. } 720$
 So, the total profit = $14500 - (720 + 250x + 12.5x) = 130$
 $\Rightarrow 262.5x = 13650$
 $\Rightarrow x = 52$
 Hence, the answer is A.
 78. Ans. E.

	Open	High	Low	Close
Monday	60	66	40	52
Tuesday	40	60	42	50
Wednesday	55	70	30	45
Thursday	45	50	40	40
Friday	35	54	32	48

Average closing price of shares of the company XYZ for the given 5 days = $\frac{52 + 50 + 45 + 40 + 48}{5} = 47$
 Average opening price of shares of the company XYZ for the given 5 days = $\frac{60 + 40 + 55 + 45 + 35}{5} = 47$

Hence, the required percentage = $\frac{47 - 47}{47} \times 100 = 0\%$.

79. Ans. A.
 Statement I:
 Passing marks of the examination = $600 \times \frac{x}{100} + 102 = 600 \times \frac{3x-4}{100} - 78$
 $6x + 102 = 18x - 24 - 78$
 $12x = 204; x = 17$

So, statement I alone is sufficient to answer the question.
 Statement II:
 We already know that the difference in the marks obtained by Ravi and Ram = $102 + 78 = 180$
 There is no additional information given in the statement. So, the value of 'x' can't be determined.
 So, statement II alone is not sufficient to answer the question.
 Thus, the data in Statement I alone are sufficient to answer the question, while

the data in Statement II alone are not sufficient to answer the question.
 So option (a) is the correct answer.
 80. Ans. C.

Statement I:
 Let, s be the speed of Train A
 According to the question,
 $\frac{x + 50}{s + 5} = 10$
 $x + 50 = 10(s + 5)$

Also,
 $\frac{x + 50}{s - 5} = 15$
 $x + 50 = 15(s - 5)$

Using both the equations, we get,
 $10(s + 5) = 15(s - 5)$
 $2s + 10 = 3s - 15$
 $3s - 2s = 10 + 15$
 $s = 25 \text{ m/s}$

So, $(x + 50) = 10(25 + 5) = 300 \text{ m}$
 Therefore, length of Train A = 300 m
 So, statement I alone is sufficient to answer the question.

Statement II:
 Let, s be the speed of Train A
 According to the question,
 $\frac{[(x + 50) + (x + 150)]}{s + 10} = 20$
 $2x + 200 = 20(s + 10)$

Also,
 $\frac{[(x + 50) + (x + 150)]}{s} = 28$
 $2x + 200 = 28s$

From both equations, we get
 $20(s + 10) = 28s$
 $20s + 200 = 28s$
 $8s = 200; s = \frac{200}{8} = 25 \text{ m/sec}$

So, $2x + 200 = 28 \times 25$
 $2x + 200 = 700$
 $x = \frac{500}{2} = 250$

Gradeup Green Card
 Unlimited Access to All 700+ Bank & Insurance Mock Tests

CLICK HERE

Therefore, length of Train A = $250 + 50 = 300\text{ m}$

So, statement II alone is sufficient to answer the question.

Thus, the data either in Statement I or in Statement II alone are sufficient to answer the question.

So option (c) is the correct answer.

81. Ans. D.

* The government has also proposed to allocate Rs 70,000 crore for PSU bank recapitalisation and has enhanced the target for disinvestment to Rs 1,05,000 crore.

* FM Sitharaman specified multiple provisions and structural changes towards the banking sector, starting with provision of about Rs 70,000 crore in terms of additional capital infusion to state-owned banks to support credit improvement.

* The Budget also proposed to provide PSU banks one-time 6-month credit guarantee of Rs 1 lakh crore to buy high-rated pooled assets of "sound" NBFCs, adding that fundamentally sound NBFCs will keep getting funding from banks, Mutual Funds.

82. Ans. C.

• Aviva Life Insurance has announced the launch of 'Wings', a specially designed mentorship program to empower the female workforce.

• The program is an initiative of the SHE division of the company, for mentoring all the women employees.

Note:

• Aviva Life Insurance is a joint venture between Dabur Invest and Aviva International Holdings, a UK-based insurance group, whose association with India goes back to 1834.

83. Ans. B.

Abhijeet Gupta claimed his fifth title as India swept medals in all 16 sections of the Commonwealth **chess** championship here on Sunday.

After two other leaders, S. L. Narayanan and Aravindh Chithambaram, drew their top board battle in 32 moves, Abhijeet caught Arjun Erigaisi in a checkmating net in 39 moves to reach 7.5 points.

84. Ans. B.

• The Union Budget has allocated ₹65,837 crore outlay for Indian Railways for the financial year 2019-20, in a bid to expand the rail infrastructure.

• The capital expenditure has been increased to ₹1.6 lakh crore in 2018-19 from ₹1.39 lakh crore a year ago.

85. Ans. C.

• The state government of Kerala and the World Bank has signed USD 250 Million loan agreement for the First Resilient Kerala Program to enhance the State's resilience against the impacts of natural disasters and climate change.

• The Resilient Kerala Program will focus on strengthening the State's institutional and financial capacity to protect the assets and livelihoods of poor and vulnerable groups through an inclusive and participatory approach.

• The 2018 floods and landslides in Kerala led to severe impact on property, infrastructure, and lives and livelihoods of people.

86. Ans. D.

Madhya Pradesh CM Kamal Nath has launched the state Government's flagship scheme 'Mukhyamantri Yuva Swabhiman Yojana' to urban youths (21-30 years) from economically weaker sections.

Under the scheme, Rs 4,000 stipend per month will be given for 100 days of employment every year.

87. Ans. C.

* The fiscal deficit target for the financial year 2019-20 is **3.3% of GDP**, lower than the **3.4% estimated earlier** in the interim Budget presented in February 2019.

* The fiscal deficit is the difference between the government's total expenditure and its total receipts (excluding borrowing) during a fiscal year. In simple words, it is the amount of borrowing the government has to resort to meet its expenses.

88. Ans. D.

• State Government of **Karnataka**, the state which have largest drought-prone land in the country has launched the water conservation scheme "**Jalamrutha**".

- This scheme focuses on drought proofing measures, including protection and rejuvenation of waterbodies.
- It will deploy scientific approaches for water budgeting, water harvesting and water conservation through the use of geospatial data, satellite imagery, topographical and geological data.
- Under this scheme water conservation strategy comprises four components of water literacy, rejuvenation of water bodies, creation of new water bodies as well as development of watersheds and afforestation activities.
- This will operate on a four-tier institutional structure with planning and execution committees being set up at village, taluk, district and State levels.
- Karnataka Government has decided to declare 2019 as the '**Year of Water**' to emphasise the importance of water becoming a scarce commodity and the need to conserve it.

89. Ans. C.

- Bank of Maharashtra (BoM) has partnered with M1Xchange Trade Receivables Discounting System (TReDS) platform for MSME bill discounting.
- TReDS is a digital platform to support micro, small and medium enterprises (MSMEs) to get their bills financed at a competitive rate through an auction where multiple registered financiers can participate.
- In addition to TReDS platform of Receivables Exchange of India Ltd (RXIL) & Invoicemart (A.TREDS Ltd), the bank has now on-boarded as financier on the TReDS platform of M1Xchange of Mynd Solutions

90. Ans. A.

- National record holder Dutee Chand became the first Indian woman track and field athlete to clinch a gold medal at the 30th Summer University Games in Napoli, Italy.
- She won the 100m dash event here.
- The 23-year-old Dutee clocked 11.32 seconds to win the gold as she led the race from start to finish.

91. Ans. D.

- **Virat Kohli** won the International Cricketer and Batsman of the Year award

during the CEAT Cricket Rating (CCR) International awards 2019.

- **Jasprit Bumrah** adjudged as International Bowler of the Year.
- **Cheteshwar Pujara** adjudged as International Test Cricketer of the Year.
- **Rohit Sharma** adjudged as International ODI Cricketer of the Year.

92. Ans. C.

A unique strategy adopted by Northeast Frontier Railway (NFR) called 'Plan Bee' to keep wild elephants away from train tracks has won the 'Best Innovation Award' in Indian Railways for the 2018-19 fiscal. The prize is awarded by Indian Railways and comprises of a citation and a cash award of Rs.3 lakh.

- Plan Bee- It is an amplifying system that imitates the buzz of a swarm of honey bees to keep wild elephants away from railway tracks.

- As per NFR officials, a mix of Plan Bee and other measures have helped them save 1,014 elephants from 2014 to June 2019.

93. Ans. D.

The Reserve Bank of India (RBI) board has finalised a three- year roadmap named "Utkarsh 2022" to improve regulation and supervision and various other functions of the central bank.

To identify issues that needed to be addressed over the next three years, an internal committee was formed.

It was headed by outgoing Deputy Governor Viral Acharya.

94. Ans. D.

- The International Day of Happiness 2019 was celebrated on March 20 with the theme Happier Together, focusing on what we have in common, rather than what divides us.

- International Day of Happiness recognises the importance of happiness in the lives of people around the world.

- The concept of International Day of Happiness was conceptualised and materialised by UN special advisor Jayme Illien to inspire and spread a happiness movement globally and the first ever international day of happiness was observed on March 20, 2013.

95. Ans. C.

- Deposits in bank accounts opened under Jan Dhan scheme, launched about five years ago by the Modi-government, have crossed the Rs 1 lakh crore mark.

- As per the latest finance ministry data, the total balance in over 36.06 crore Pradhan Mantri Jan Dhan Yojana (PMJDY) accounts was at Rs 1,00,495.94 crore as on July 3.

96. Ans. A.

Captain Aarohi Pandit, a 23-year-old pilot from Mumbai became the world's first woman to cross the Atlantic Ocean solo in a Light Sports Aircraft (LSA), thrilling her family, friends and aviation circles.

She achieved the feat around midnight on May 13-14 when she landed her tiny aircraft at Iqaluit Airport in Canada, after a gruelling 3,000 km long flight, under adverse and extreme weather conditions the following take-off from Wick, Scotland (United Kingdom), with brief stopovers in Greenland and Iceland.

97. Ans. B.

- According to the survey conducted by the Randstad Employer Brand Research (REBR) 2019, Amazon India is the country's most attractive employer brand.

- Microsoft India emerged as the runner-up, followed by Sony India.

- According to the REBR 2019 report, Amazon scored high on financial health, utilisation of the latest technologies and a strong reputation.

- Others in the top 10 are Mercedes-Benz (4th), IBM (5th), Larsen & Toubro (6th), Nestlé (7th), Infosys (8th), Samsung (9th), and Dell (10th).

- Google India had been inducted into the REBR's Hall of Fame category last year for winning the coveted title of the most-attractive employer brand for three consecutive years.

98. Ans. B.

HDFC Bank has been identified as number 1 bank by customers in India, as per Forbes World's Best Bank survey.

HDFC Bank emerged as India's No 1 bank. ICICI Bank was at number 2 and SBI was surprisingly ranked 11th in the list.

99. Ans. B.

- The Indigenous Pinaka rocket system of the Defence Research and Development Organisation (DRDO), known for firing a salvo of 12 rockets in just 44 seconds, is being evolved into a precision-guided missile, with enhanced range and accuracy to hit its targets. The missile, which has completed the initial trial, will undergo developmental trials and is expected to be delivered to the Army in two years

- The initial version of the Pinaka rocket was further developed into Pinaka Mark II, which has an enhanced range of 70 to 80 km compared to Mark I, with a range of 40 km. The rocket has been developed by the Armament cluster of the DRDO, with a lead from Pune-based Armament Research and Development Establishment (ARDE). Along with ARDE, the High Energy Material Research Laboratory in Pune and two DRDO establishments in Hyderabad have contributed to the development.

100. Ans. C.

- Reserve Bank of India has on December 1, 2016 authorised Receivables Exchange of India Limited (RXIL) to launch India's first trade receivables exchange platform - an online market place for MSMEs, Buyers and Financiers.

- RXIL has been promoted by SIDBI, the apex financial institution for promotion and financing of MSMEs in India and National Stock Exchange of India Limited (NSE) the premier stock exchange in India.

101. Ans. A.

- The IFSC is an 11-character code with the first four alphabetic characters representing the bank name, and the last six characters (usually numeric, but can be alphabetic) representing the branch.

- The fifth character is 0 (zero) and reserved for future use.

102. Ans. A.

Ministry of Housing and Urban Affairs (MoHUA) has partnered with Microsoft India to use the platform Project Sangam of Microsoft on its Swachh Bharat e-Learning Portal.

103. Ans. B.

Gradeup Green Card

Unlimited Access to All 700+ Bank & Insurance Mock Tests

[CLICK HERE](#)

- The Reserve Bank of India (RBI) constituted a committee under **Harsh Vardhan**, to review existing state of mortgage securitisation in India and suggest measures to develop market further.

- The committee constitutes a six-member panel that is headed by Harsh Vardhan, Senior Advisor in Bain & Company (a Management consulting company).

- It shall submit its report to RBI by the end of August 2019.

Objective:

- To review existing state of mortgage backed securitisation in India and also suggests measure to deepen housing finance securitisation market.

- To assess role of various counterparties in securitisation process which includes servicers, rating agencies, trustees, and also suggest steps to address key risks.

104. Ans. B.

- The full form of NCLT is National Company Law Appellate Tribunal.

- It is a quasi-judicial body in India that adjudicates issues relating to Indian companies.

105. Ans. E.

- The Global Gender Gap Report ranks 144 countries on the progress they have made towards gender parity in four areas – health, education, economics and politics.

- The report's Gender Gap Index ranks countries according to calculated gender gap between women and men in four key areas: health, education, economy and politics to gauge the state of gender equality in a country.

- The report measures women's disadvantage compared to men, and is not strictly a measure of equality.

106. Ans. E.

The World Bank and the Commonwealth Bank of Australia (CommBank) have teamed up to enable recording of secondary market bond trading using blockchain tech.

The institutions announced that their successful recording of a secondary transaction for bond-i, a blockchain-operated debt instrument, on a

distributed ledger shows the "vast potential" of the technology, and marks the first bond to have both issuance and trading recorded on a blockchain platform.

Bond-i was first issued last August by the World Bank, with the CommBank being a sole arranger. The experiment helped the World Bank raise \$81 million at the time.

107. Ans. C.

ICICI Bank has entered into an agreement with the BSE to buy a stake in its subsidiary INX - located at GIFT City Gujarat - for nearly Rs 31 crore.

India International Exchange (INX) - a wholly-owned subsidiary of the BSE - is India's first international exchange at International Financial Services Centre (IFSC) in GIFT City.

The investment is subject to regulatory approvals and comes at a cash consideration of up to Rs 305 million in tranches to acquire up to 9.9 per cent shareholding in INX, ICICI Bank said in a regulatory filing.

108. Ans. C.

The Indian Space Research Organisation's (ISRO) new commercial arm called NewSpace India Limited (NSIL) was officially inaugurated in Bengaluru, Karnataka.

NSIL will be responsible for manufacturing the and production of Small Satellite Launch Vehicle (SSLV) and Polar Satellite Launch Vehicle (PSLV) through technology transfer mechanisms.

109. Ans. D.

- On 3rd March 2019, central government approved the proposal for setting up of a Centre for Disability Sports at Gwalior.

- This centre at Gwalior will be set up with an estimated cost of Rs 170.99 crores over a period of 5 years.

- Improved sports infrastructure will ensure effective participation of Persons with Disabilities (PwDs) in sports activities and also enable them to compete at national and international levels.

- Setting up of this Centre will develop a sense of belonging in Divyangjan to facilitate their integration in society.

110. Ans. C.

- Trading of priority sector lending certificates (PSLCs) on the government's e-Kuber portal by banks will attract integrated goods and services tax (IGST).
- However, if the bank has already paid Central and State GST for the transaction, then it will not have to pay IGST.
- The clarification comes after the CBIC received representations from a number of banks on whether GST has to be paid for trading of PSLC on the e-Kuber portal of the Reserve Bank of India.
- PSLCs are aimed at encouraging banks to lend more to priority sectors, such as agriculture, small and marginal farmers and micro enterprises. About 40 per cent of the total lending of banks has to be to these sectors.
- Banks that do higher lending can issue these certificates, which can be bought by banks that have a shortfall in their priority sector lending. These are traded on the RBI's e-Kuber portal.

111. Ans. C.

- The government's flagship pro-poor scheme Pradhan Mantri Ujjwala Yojana (PMUY) has found maximum success in Delhi, Goa, Haryana, Uttarakhand and Puducherry.
- These are the states with the maximum percentage of beneficiaries who availed at least four cooking gas refills in the period between May 2016 and June 2019.
- Telangana, Chhattisgarh and Tripura were in the bottom of the list.
- Delhi topped the list of states with maximum percentage of PMUY beneficiaries availing at least four refills. Delhi had 63,894 beneficiaries at the end of December 2018. Of these, 86 per cent or 54,695 availed at least 4 refills.
- An average PMUY beneficiary in the national capital consumed 8 LPG refills in the three-year period.

112. Ans. A.

The G-20 Finance Ministers and Central Bank Governors' Meeting was held in **Fukuoka, Japan.**

Finance Minister Nirmala Sitharaman attended the two-day meeting of G-20 Finance Ministers and Central Bank governors in Japan.

The deliberations at the meeting would be followed by the G-20 Leaders' Summit scheduled on June 28-29 at Osaka.

Saudi Arabia will host the G20 summit in November 2020.

113. Ans. D.

Prof. Ramesh Chand (Member, Niti Aayog) will be the chairman of the 18-member committee.

The Office of Economic Adviser, Department for Promotion of Industry and Internal Trade will be the nodal office for the Working Group.

Since 2011-12, significant structural changes have taken place in the economy.

114. Ans. A.

Sarada Kumar Hota has been appointed as the Managing Director of the National Housing Bank (NHB).

Earlier, Mr. Hota has served as the managing director of Can Fin Homes (subsidiary of Canara Bank).

115. Ans. B.

Sri Lanka inaugurates first model village built with Indian assistance –

The first model village built with Indian assistance under the Model Villages Program was inaugurated at Ranidugama in Gampaha in Sri Lanka.

116. Ans. B.

Popularly known as 'Pink City', Jaipur made an official entry in the list of the UNESCO World Heritage sites recently at the 43rd session of the Unesco World Heritage Committee.

The Walled City of Jaipur (Rajasthan) known for its iconic architectural legacy and vibrant culture, on made its entry into the UNESCO World Heritage Site list. The announcement was made after the 43rd Session of the UNESCO World Heritage Committee, underway at Baku (Azerbaijan).

With this, India now has **38 World Heritage Sites**(30 cultural properties, 7 natural properties and one mixed site).

117. Ans. E.

- Persons resident in India as defined under Foreign Exchange Management Act, 1999 are eligible to invest in SGB.

- Eligible investors include individuals, HUFs, trusts, universities and charitable institutions.

- Individual investors with subsequent change in residential status from resident to non-resident may continue to hold SGB till early redemption/maturity.

118. Ans. D.

- Bharat Sanchar Nigam Limited (BSNL) has announced the launch of its new Wings application in India on Google Play Store.

- As a part of the introductory offer, the state-owned telecom operator is providing one free month of free Wings service to its new customers.

- The company has revealed that customers will get one month of free Wings services, though the service will be available at an initial one-time annual fee of Rs 1099 plus GST once the free period is over

119. Ans. A.

The Reserve Bank of India (RBI) has appointed R Gandhi (former Deputy Governor of RBI) as Additional Director on the board of private sector lender YES Bank for a period of two years.

Gandhi was RBI Deputy Governor during April 2014 and April 2017.

120. Ans. E.

The **World Happiness Report 2019**, which ranks 156 countries by how happy their citizens perceive themselves to be, according to their evaluations of their own lives, was launched today at the United Nations. The report was produced in partnership with **The Ernesto Illy Foundation**.

According to the **World Happiness Report 2019**, India's ranking went down to **140**.

* In 2018, India was placed on **133 positions**.

* In this report, Pakistan stands at 67th rank, China at 93, Bhutan at 95, Nepal at 100, Bangladesh at 125 and Sri Lanka at 130.

* The World Happiness Report 2019 has disclosed the list of happiest and unhappiest countries worldwide.

* **Finland**, for the second consecutive year, has topped this list. It is followed by

Denmark, Norway, Iceland, Netherlands, Switzerland, Sweden, New Zealand, Canada and Austria.

This year's happiness report focuses on happiness and the community: how happiness has evolved over the past dozen years, with a focus on the technologies, social norms, conflicts and government policies that have driven those changes.

Special chapters focus on generosity and prosocial behaviour, the effects of happiness on voting behaviour, big data, and the happiness effects of internet use and addictions.

121. Ans. E.

The passage talks about surveys where people say that "...hard work is either "essential" or "very important" when it comes to getting ahead..." and "...external factors, such as luck and coming from a wealthy family, are much less important". So, both options A & D are correct. Hence, the correct answer is E.

122. Ans. C.

Only option C is correct. The reasons are as follows:

A: 'even playing field' refers to a situation in which everyone has the same chance of succeeding. So, option A is wrong.

B & C: "Although widely held, the belief that merit rather than luck determines success or failure in the world is demonstrably false" clearly states that no one has successfully implemented meritocracy. The phrases 'widely held belief' and 'demonstrably false' prove option C is correct. So, option B is wrong and option C is correct.

D: "...the lottery of birth..." refers being born into a wealthy family. So, option D is wrong.

Hence, the correct answer is C.

123. Ans. B.

To be factual means to provide us with actual details or information rather than ideas or feelings about it. The passage mentions a belief and then uses facts to state the truth. Hence, the correct answer is B.

124. Ans. D.

In the sentence, the tense is incorrect. "Being" is not followed by "is". And out of the options, both i and iii can make a correct sentence. Option ii is incorrect as 'during' talks about a phase of time while 'in' is used to locate a specific moment in time. Thus, the correct answer is option D.

125. Ans. A.

The statement is in the simple past tense form. Thus, the correct option will be A.

126. Ans. E.

In option i and ii, 'met on' and 'meeting of' are incorrect phrases. In sentence iii, the 'been' is followed by 'ing' form of the verb. Moreover, the sentence is correct in itself and no correction required. Thus option E is the correct answer.

127. Ans. B.

"Because" is used to give reason or a cause. Hence, it cannot be used in this statement. Option i is incorrect because the statement is in present perfect tense and 'was' is not applicable here. In case of option iii, one can't be chosen 'within' a prize. One can be chosen for a prize or nominated for a prize. Thus, the correct option is statement ii. The correct answer is option B.

128. Ans. A.

The first part that says the Ramayana "...takes scant notice of her..." is correct. But when the passage says "...essentially a 14-year long coma..." it means that Urmila was ignored for 14-years. She wasn't actually injured. To hold the fort means to have responsibility for something while someone else is absent. There was no attack. Also, the last paragraph is describing Kane's version of the Ramayana, which is fiction. But the inference implies that it is not fictional. So, the given inference is definitely false. Hence, the correct answer is A.

129. Ans. A.

Only option A is correct about 'Uruvi'. The reasons are as follows:

A: The author describes Uruvi as "...of the low caste..." and calls it a "...subaltern voice...". This means that casteism has not been in the Mahabharata originally. So, option A is correct.

B: "Kane's inspiration for this name seems to have come from some references in later Tamil literature, where Karna's wife is named Ponnaruvi. However, it is conjectured that Ponnaruvi was an epithet for either Vrushali or Supriya or both." Here, 'this name' refers to Uruvi. Clearly, Uruvi had inspirations from history. So, option B is wrong.

C & D: "The Mahabharata speaks of no one called Uruvi" which means that there was no Uruvi in the original version to be ignored or to be unjust. So, option C & D are wrong.

Hence, the correct answer is A.

130. Ans. D.

Only option C is the correct option. The reasons are as follows:

A: The passage gives two examples of Kane's writings where the protagonist is a female in the Mahabharata and the Ramayana. The writers are also said to "...have passionately taken up the cause of feminist revisionist mythology." So, option A is correct.

B: "Kane's inspiration for this name seems to have come from some references in later Tamil literature, where Karna's wife is named Ponnaruvi. However, it is conjectured that Ponnaruvi was an epithet for either Vrushali or Supriya or both." indicates that Uruvi was not completely fictional. So, option B is correct.

C: "...we deal with not one but two subaltern voices..." These two subaltern or people of lower status refer to being woman and belonging to lower caste. So, option C is wrong.

Hence, the correct answer is D.

131. Ans. A.

In the part C, the presence of indicator 'The' states that this is the beginning of the sentence. Part C ends with the adverb 'usually' which means generally. Thus, it needs a verb to qualify. Part D follows as it makes perfect sense and it begins with the verb 'applied'. The sentence ends with the pronoun who. Part B follows as it means it is the mentor who moulds. It makes perfect sense. Part A ends the statement in the logical manner as it

concludes the role of the mentor. Option A, CDDBA, is the correct answer.

Thus, the correct sentence is: "The word mentor is usually applied to the one who moulds a young, naive person into a force within a field"

132. Ans. C.

In English grammar, we can use 'it' as an 'empty' subject. It is 'empty' because it doesn't refer to anything. In this case, B is the beginning of the sentence as the word 'it' work as the dummy subject which introduces the sentence. 'Our' is a determiner which is preceded by noun. So, A follows statement B as it is the only part which begins with the noun. Thus, BA becomes a pair.

Now, CD makes a pair as it talks about how a good mentor can help one to navigate one' career successfully. Now CD follows BA as it concludes the statement in a meaningful manner. Thus, BACD is the correct sequence. Option C is the correct answer.

The correct sentence is: "It is important throughout our careers and not just at the start as a good mentor can help one to navigate one's career successfully"

133. Ans. D.

Out of the given of options, Option A is invalid as 'do' does not introduces the sentence. Similarly, may is a modal verb. Introducing the sentence in the following scenario does not make any sense. Thus, option B and E becomes invalid.

Out of option C and D, statements BC makes a pair. Statements C ends with the modal 'should'. Now 'should' is used to give emphasis. It cannot be followed with modal verb 'may' as it provides possibility. Thus, the C must be followed by statement D. The correct sequence is BCDA. Thus, option D is the correct answer.

The correct sentence is: "A common perception when seeking a mentor in that area is that we should do it when we are new to a profession but that may not be when we meet them the most"

134. Ans. B.

Statement A introduces the premise of the statement. It talks about the scenario in reality. Thus, A is the first part of the

statement. Thus, option C, D and E gets invalid. Now, in option A and B, we see statement AB as a pair.

Statement DC makes a pair as it talks about capable grownups needs guidance at the workplace. The pair makes perfect sense as well.

Statements AB thus needs to be followed by DC to make a complete sense. The correct sequence is this ABDC. Option B is the correct answer.

The correct sentence is: "In reality, that's not always the dynamic or the demographic, of the mentor-mentee relationship, as capable grownups need guidance too, especially at the workplace"

135. Ans. D.

The four sentences are:

1. The word mentor is usually applied to the one who moulds a young, naive person into a force within a field.

2. It is important throughout our careers and not just at the start as a good mentor can help one to navigate one's career successfully.

3. A common perception when seeking a mentor in that area is that we should do it when we are new to a profession but that may not be when we meet them the most.

4. In reality, that's not always the dynamic or the demographic, of the mentor-mentee relationship, as capable grownups need guidance too, especially at the workplace.

Sentence 1, 2 and 3 talks about role and function of a mentor in an individual's career. It also mentions where can or cannot find a mentor.

However, statement 4 is a comment of the mentor-mentee relationship. Thus, it deviates from the functions of the mentor to the relationship shared between mentor and mentee and how even grownups need guidance. Thus, option D is the correct answer.

136. Ans. A.

Wretched when used as an adjective, means to be in a very unhappy or unfortunate state.

Troubled, as an adjective, means beset by problems or difficulties.

Injured as an adjective, means harmed, damaged, or impaired.

Downtrodden as an adjective, means oppressed or treated badly by people in power.

Elated as an adjective, means very happy and excited because of something good that has happened, or will happen.

The last sentence in the stanza says that men are miserable, and women should be too. This means that women were expected to be miserable or unhappy. Hence, the correct answer is A.

137. Ans. D.

"IAS match" indicates that parents are ready to have a groom based on the fact that the men have qualified IAS. So, option A is correct.

The statement talks about the 'ambition' of the parents. It doesn't specify what the groom or the bride think about the marriage. So, option B is correct.

To descend means to make a sudden attack on. The movement of the parents being compared to an attack, shows how desperate the parents were. So, option C is correct.

The adjective "ambitious" is used for the parents. The daughters' opinion is not known. So, option D is wrong.

Hence, the answer is D.

138. Ans. E.

"It was in Delhi that he had met Jyoti...". Here, he refers to Ashok. Ashok had met Jyoti and most likely was introduced to her father by Jyoti herself. So, option A is wrong. The passage never goes out of the way to say that Jyoti doesn't like Ashoke. Given that she is the one who introduced Ashok to her father, it is very likely she likes Ashok. So, option B is also wrong. "Every alternate weekend, he would head to Shakti Nagar in Delhi to meet her, before hightailing it back to Narnaul". Clearly Ashok and Jyoti did not live together. So, option C is wrong. Hence, the answer is E.

139. Ans. A.

To hit it off means to be friendly with each other immediately. When you **get along** with someone, you're friendly or

compatible with them. Ashoke "...had not exactly hit it off with his boss..." which means that Ashok and his boss didn't get along very well. So, option I is correct.

Since it is not specified who followed Ashok, option II is wrong. The passage only states Jyoti's wish to do journalism. So, option III is also wrong.

Hence, the correct answer is A.

140. Ans. C.

The word 'recent' is an adjective. It needs a noun to modify. Thus, the first blank needs a noun. Thus, the possibility comes down to option a and c. In the second blank, a verb is needed as it talks about an idea or theory which depends on primacy of communicative activities in the classroom.

Thus, the word 'rests' fits in perfectly as it means 'be based on; depend on.' Out of all the combination of options given, option C is the correct one. In the first blank the word 'theory' fits and in the second blank the word 'rests' fits.

Option C is the correct answer.

141. Ans. A.

The word 'huge' is an adjective. It needs a noun to modify. Thus, the first blank needs a noun. Thus, the possibility comes down word 'a' or word 'c'.

Option B won't fit in the blank as word 'b' is not appropriate for blank 1. In case of option C, word 'f' will not fit in second blank because it does not make any sense. Thus, only other option with word 'c' is option A. Both the words 'c' and 'd' fit perfectly in the blanks respectively, and it is the correct answer.

142. Ans. B.

The sentence talks about what French revolutionaries thought about guillotine as a method of the death. Thus, word 'b' fits perfectly as it means 'having been thought about carefully'. In the second blank, words d, e and f fit perfectly. Thus, option B is the correct.

143. Ans. C.

The sentence talks about results of repayment of loan. The word b won't fit in the first blank as the sentence is in simple present tense. So out of the given options, the one with word b gets invalid. Now let's look at option E. Even though

combination of a-e makes sense, because if we withhold a repayment of loan, we increase the repayment of loan, the combination a-d does not make any sense withholding repayment will not reduce the amount of loan. Thus, the most plausible combination is given in Option C. Both the words fit perfectly and make complete sense. Thus, Option C is the correct answer.

144. Ans. B.

The second blank is preceded by helping verb 'have'. As per rule of grammar, have/has +Verb(V3) (Past Participle). Thus, word e fits the blank perfectly. Similarly, is verb+ing form as the sentence is present continuous tense. Thus, word a and word c fits perfectly. However, there is no option which incorporates c with e and a with e. The correct combination is offered by the option B. Thus, it is the correct answer.

145. Ans. C.

The given passage is about expenditure in the defence sector of an economy. The passage states that it is important for national security but is affected by limited resources and the demands of other sectors. These two points make the ability of a nation to meet its defence requirements limited. This has been explained in option C making it the correct answer.

146. Ans. B.

'Ambiguities' is the plural form of 'ambiguity' which means the quality of being open to more than one interpretation. The meaning of the given options are as follows –

Equivocation – the use of ambiguous language to conceal the truth or to avoid committing oneself.

Luminosity – luminous quality.

Transparency - the quality of being open, honest, and direct.

From the above meanings it is clear that while 'equivocation' is synonymous to the given word, 'transparency' is its antonym. Thus, option B is the correct answer.

147. Ans. D.

As per the given passage, affordability of military spending varies on two basis – it varies in degree and also over time. Thus,

statement I is incorrect as it states that military spending is constant.

The passage states that changes in degree of affordability showcases the changes in what is being perceived as threat. This has been stated in sentence II, making it true.

The passage ends with a commentary on the US military spending and how it is causing economic distress. Thus, statement III is also correct.

Hence, option D is the correct answer.

148. Ans. B.

The author is portraying a sense of gloom and nothingness in the passage with a sense of loneliness. Hence the correct option is C.

149. Ans. B.

The sentence with the blank states that the food that comes from the relationship between nature and nurture is a direct result of the richness in the differences of our regions. Off the given options, 'biodiversity' which means the variety of plant and animal life in the world or in a particular habitat, a high level of which is usually considered to be important and desirable, is the best fit word for the given blank. Thus, option B is the correct answer.

150. Ans. B.

The passage clearly blames the condition of obesity on lack of good nutritious food. (We did this because it was becoming clear the world was (and is) facing an obesity pandemic – much of the food we eat today is bad for health, with no nutrition or goodness.) thus, statement I is true.

It also states that the current generation is heavily influenced by mass media which is also affecting their food habits. (We are children of the age of processed and factory-grown foods, who have been trans-mutated through a deliberate and subliminal marketing that has changed our habits and our culture of food.) Thus, statement II is also true.

But statement III is false. The passage states that the incidence of diabetes is on the rise among the urban poor. 'Pandemic' means prevalent over a whole country or the world, which makes the

statement incorrect. Thus, option B is the correct answer.

151. Ans. D.

The given sentence means that in order to better protect our wilds and our environment, we first need to appreciate the offering in the form of a diverse variety of nutritious food that nature offers. This has been conveyed in option D making it the correct answer.

152. Ans. D.

The author is describing facts about the old caves discovered in France, without passing off any judgements. Hence the correct option is D.

153. Ans. B.

The first paragraph of the passage states clearly that one of the biggest reasons behind poverty is the financial exclusion of the poor and under privileged groups in India. The groups lack financial education which leads to lack of opportunities for the groups to become financially stable. Thus, not only financial inclusion is necessary, but also, the groups need to be financially educated. Thus, both statements I and III are

necessary pre requisites for poverty reduction and social upliftment. So, option B is the correct answer.

154. Ans. E.

All given statements are grammatically correct. But option E is contextually incorrect. The passage clearly states that it is financial 'exclusion' that is one of the main reasons behind the growth of poverty in the country. 'Inclusion' as mentioned in option E implies a completely opposite school of thought making option E contextually incorrect.

155. Ans. C.

The passage states - 'One of the main reasons why mass poverty is persisting in India is that the problem of financing the poor still remains unresolved (RBI, 2011a), ...'. This indicates that the reason behind mass poverty is the problem of access to proper financial sources. It is further aggravated by the financial illiteracy of the poor in the country. Hence, option C is the correct inference regarding mass poverty as per the passage.

Gradeup Green Card

Unlimited Access to All 700+ Bank & Insurance
Mock Tests

[CLICK HERE](#)



Gradeup Green Card

Features:

- › 700 + Full-length Mocks
- › 35+ Bank & Insurance Exams Covered
- › Tests Available in English & Hindi
- › Performance Analysis & All India Rank
- › Previous Year Question Papers in Mock Format
- › Available on Mobile & Desktop



www.gradeup.co