

JEE (ADVANCED) 2018 PAPER – 1 ANSWER KEY

| Q. No. | PHYSICS | CHEMISTRY | MATHEMATICS |
|--------|---------|-----------|-------------|
| 1. | B, C | B, C | A, B, D |
| 2. | A, C | B, C | B, C, D |
| 3. | A, C | A, B, C | C, D |
| 4. | B, D | B | A, B, D |
| 5. | A, B, D | A, B, D | B, C |
| 6. | B, C, D | B, C | B, C |
| 7. | 2.00 | 1 | 8 |
| 8. | 5.00 | 2992 | 625 |
| 9. | 0.75 | 3 | 3748 |
| 10. | 2.09 | 10 | 2 |
| 11. | 1.50 | 2.22 | 1 |
| 12. | 2.00 | 19 | 3 |
| 13. | 130.00 | 4.47 | 0.5 |
| 14. | 4.00 | 0.05 | 4 |
| 15. | C | C | A |
| 16. | D | A | D |
| 17. | B | A | A |
| 18. | C | B | C |

JEE (ADVANCED) 2018 PAPER 1

PART-I PHYSICS

SECTION 1 (Maximum Marks: 24)

- This section contains **SIX (06)** questions.
- Each question has **FOUR** options for correct answer(s). **ONE OR MORE THAN ONE** of these four option(s) is (are) correct option(s).
- For each question, choose the correct option(s) to answer the question.
- Answer to each question will be evaluated according to the following marking scheme:
 - Full Marks* : +4 If only (all) the correct option(s) is (are) chosen.
 - Partial Marks* : +3 If all the four options are correct but **ONLY** three options are chosen.
 - Partial Marks* : +2 If three or more options are correct but **ONLY** two options are chosen, both of which are correct options.
 - Partial Marks* : +1 If two or more options are correct but **ONLY** one option is chosen and it is a correct option.
 - Zero Marks* : 0 If none of the options is chosen (i.e. the question is unanswered).
 - Negative Marks* : -2 In all other cases.
- **For Example:** If first, third and fourth are the **ONLY** three correct options for a question with second option being an incorrect option; selecting only all the three correct options will result in +4 marks. Selecting only two of the three correct options (e.g. the first and fourth options), without selecting any incorrect option (second option in this case), will result in +2 marks. Selecting only one of the three correct options (either first or third or fourth option), without selecting any incorrect option (second option in this case), will result in +1 marks. Selecting any incorrect option(s) (second option in this case), with or without selection of any correct option(s) will result in -2 marks.

Q.1 The potential energy of a particle of mass m at a distance r from a fixed point O is given by $V(r) = kr^2/2$, where k is a positive constant of appropriate dimensions. This particle is moving in a circular orbit of radius R about the point O . If v is the speed of the particle and L is the magnitude of its angular momentum about O , which of the following statements is (are) true?

(A) $v = \sqrt{\frac{k}{2m}} R$

(B) $v = \sqrt{\frac{k}{m}} R$

(C) $L = \sqrt{mk} R^2$

(D) $L = \sqrt{\frac{mk}{2}} R^2$

Q.2 Consider a body of mass 1.0 kg at rest at the origin at time $t = 0$. A force $\vec{F} = (\alpha t \hat{i} + \beta \hat{j})$ is applied on the body, where $\alpha = 1.0 \text{ N s}^{-1}$ and $\beta = 1.0 \text{ N}$. The torque acting on the body about the origin at time $t = 1.0 \text{ s}$ is $\vec{\tau}$. Which of the following statements is (are) true?

(A) $|\vec{\tau}| = \frac{1}{3} \text{ N m}$

(B) The torque $\vec{\tau}$ is in the direction of the unit vector $+\hat{k}$

(C) The velocity of the body at $t = 1 \text{ s}$ is $\vec{v} = \frac{1}{2}(\hat{i} + 2\hat{j}) \text{ m s}^{-1}$

(D) The magnitude of displacement of the body at $t = 1 \text{ s}$ is $\frac{1}{6} \text{ m}$

Q.3 A uniform capillary tube of inner radius r is dipped vertically into a beaker filled with water. The water rises to a height h in the capillary tube above the water surface in the beaker. The surface tension of water is σ . The angle of contact between water and the wall of the capillary tube is θ . Ignore the mass of water in the meniscus. Which of the following statements is (are) true?

(A) For a given material of the capillary tube, h decreases with increase in r

(B) For a given material of the capillary tube, h is independent of σ

(C) If this experiment is performed in a lift going up with a constant acceleration, then h decreases

(D) h is proportional to contact angle θ

- Q.4 In the figure below, the switches S_1 and S_2 are closed simultaneously at $t = 0$ and a current starts to flow in the circuit. Both the batteries have the same magnitude of the electromotive force (emf) and the polarities are as indicated in the figure. Ignore mutual inductance between the inductors. The current I in the middle wire reaches its maximum magnitude I_{max} at time $t = \tau$. Which of the following statements is (are) true?

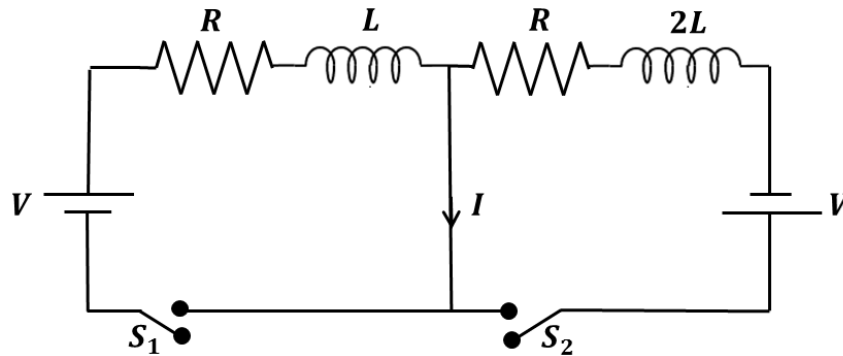

- (A) $I_{max} = \frac{V}{2R}$ (B) $I_{max} = \frac{V}{4R}$ (C) $\tau = \frac{L}{R} \ln 2$ (D) $\tau = \frac{2L}{R} \ln 2$
- Q.5 Two infinitely long straight wires lie in the xy -plane along the lines $x = \pm R$. The wire located at $x = +R$ carries a constant current I_1 and the wire located at $x = -R$ carries a constant current I_2 . A circular loop of radius R is suspended with its centre at $(0, 0, \sqrt{3}R)$ and in a plane parallel to the xy -plane. This loop carries a constant current I in the clockwise direction as seen from above the loop. The current in the wire is taken to be positive if it is in the $+\hat{j}$ direction. Which of the following statements regarding the magnetic field \vec{B} is (are) true?

- (A) If $I_1 = I_2$, then \vec{B} **cannot** be equal to zero at the origin $(0, 0, 0)$
- (B) If $I_1 > 0$ and $I_2 < 0$, then \vec{B} can be equal to zero at the origin $(0, 0, 0)$
- (C) If $I_1 < 0$ and $I_2 > 0$, then \vec{B} can be equal to zero at the origin $(0, 0, 0)$
- (D) If $I_1 = I_2$, then the z -component of the magnetic field at the centre of the loop is $\left(-\frac{\mu_0 I}{2R}\right)$

Q.6 One mole of a monatomic ideal gas undergoes a cyclic process as shown in the figure (where V is the volume and T is the temperature). Which of the statements below is (are) true?

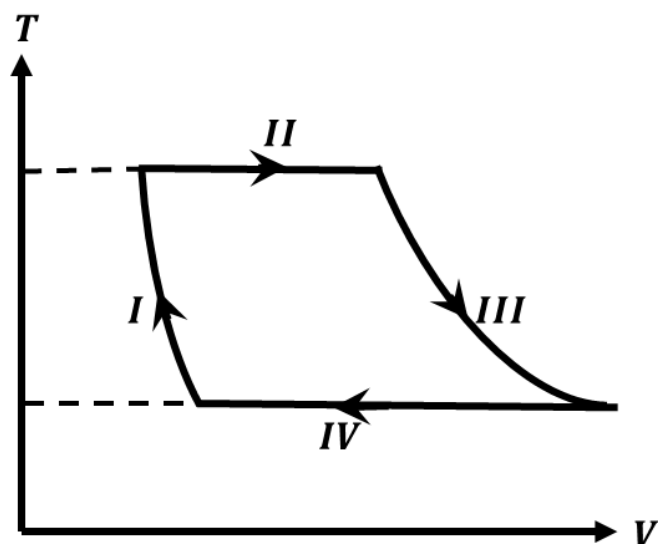

- (A) Process I is an isochoric process
- (B) In process II, gas absorbs heat
- (C) In process IV, gas releases heat
- (D) Processes I and III are **not** isobaric

SECTION 2 (Maximum Marks: 24)

- This section contains **EIGHT (08)** questions. The answer to each question is a **NUMERICAL VALUE**.
- For each question, enter the correct numerical value (in decimal notation, truncated/rounded-off to the **second decimal place**; e.g. 6.25, 7.00, -0.33, -.30, 30.27, -127.30) using the mouse and the on-screen virtual numeric keypad in the place designated to enter the answer.
- Answer to each question will be evaluated according to the following marking scheme:
Full Marks : +3 If ONLY the correct numerical value is entered as answer.
Zero Marks : 0 In all other cases.

- Q.7 Two vectors \vec{A} and \vec{B} are defined as $\vec{A} = a \hat{i}$ and $\vec{B} = a (\cos \omega t \hat{i} + \sin \omega t \hat{j})$, where a is a constant and $\omega = \pi/6 \text{ rad s}^{-1}$. If $|\vec{A} + \vec{B}| = \sqrt{3}|\vec{A} - \vec{B}|$ at time $t = \tau$ for the first time, the value of τ , in *seconds*, is _____.
- Q.8 Two men are walking along a horizontal straight line in the same direction. The man in front walks at a speed 1.0 m s^{-1} and the man behind walks at a speed 2.0 m s^{-1} . A third man is standing at a height 12 m above the same horizontal line such that all three men are in a vertical plane. The two walking men are blowing identical whistles which emit a sound of frequency 1430 Hz . The speed of sound in air is 330 m s^{-1} . At the instant, when the moving men are 10 m apart, the stationary man is equidistant from them. The frequency of beats in *Hz*, heard by the stationary man at this instant, is _____.
- Q.9 A ring and a disc are initially at rest, side by side, at the top of an inclined plane which makes an angle 60° with the horizontal. They start to roll without slipping at the same instant of time along the shortest path. If the time difference between their reaching the ground is $(2 - \sqrt{3})/\sqrt{10} \text{ s}$, then the height of the top of the inclined plane, in *metres*, is _____.
 Take $g = 10 \text{ m s}^{-2}$.

- Q.10 A spring-block system is resting on a frictionless floor as shown in the figure. The spring constant is 2.0 N m^{-1} and the mass of the block is 2.0 kg . Ignore the mass of the spring. Initially the spring is in an unstretched condition. Another block of mass 1.0 kg moving with a speed of 2.0 m s^{-1} collides elastically with the first block. The collision is such that the 2.0 kg block does not hit the wall. The distance, in *metres*, between the two blocks when the spring returns to its unstretched position for the first time after the collision is _____.

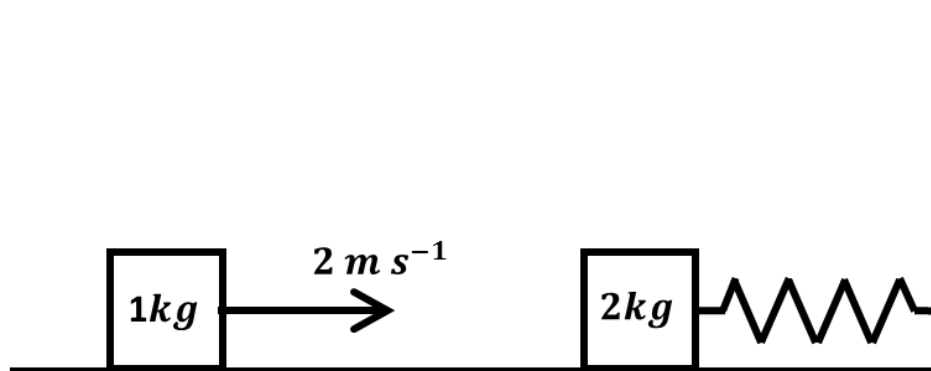

- Q.11 Three identical capacitors C_1 , C_2 and C_3 have a capacitance of $1.0 \mu\text{F}$ each and they are uncharged initially. They are connected in a circuit as shown in the figure and C_1 is then filled completely with a dielectric material of relative permittivity ϵ_r . The cell electromotive force (emf) $V_0 = 8 \text{ V}$. First the switch S_1 is closed while the switch S_2 is kept open. When the capacitor C_3 is fully charged, S_1 is opened and S_2 is closed simultaneously. When all the capacitors reach equilibrium, the charge on C_3 is found to be $5 \mu\text{C}$. The value of $\epsilon_r =$ _____.

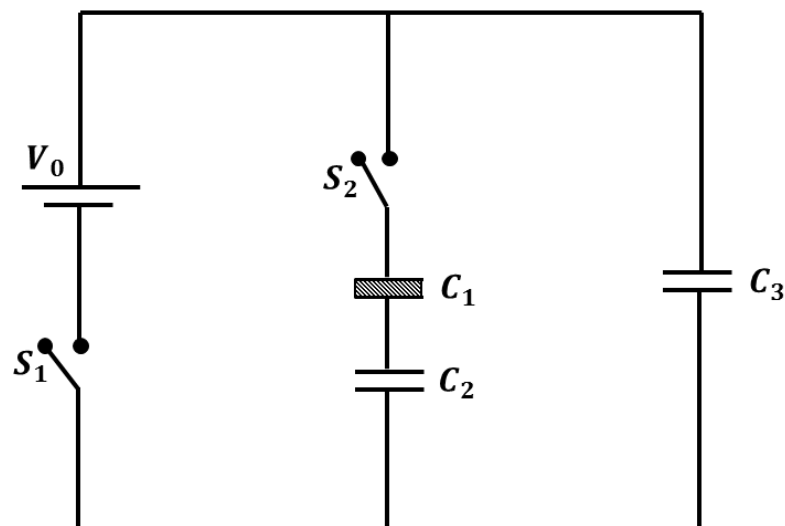

- Q.12 In the xy -plane, the region $y > 0$ has a uniform magnetic field $B_1 \hat{k}$ and the region $y < 0$ has another uniform magnetic field $B_2 \hat{k}$. A positively charged particle is projected from the origin along the positive y -axis with speed $v_0 = \pi m s^{-1}$ at $t = 0$, as shown in the figure. Neglect gravity in this problem. Let $t = T$ be the time when the particle crosses the x -axis from below for the first time. If $B_2 = 4B_1$, the average speed of the particle, in $m s^{-1}$, along the x -axis in the time interval T is _____.

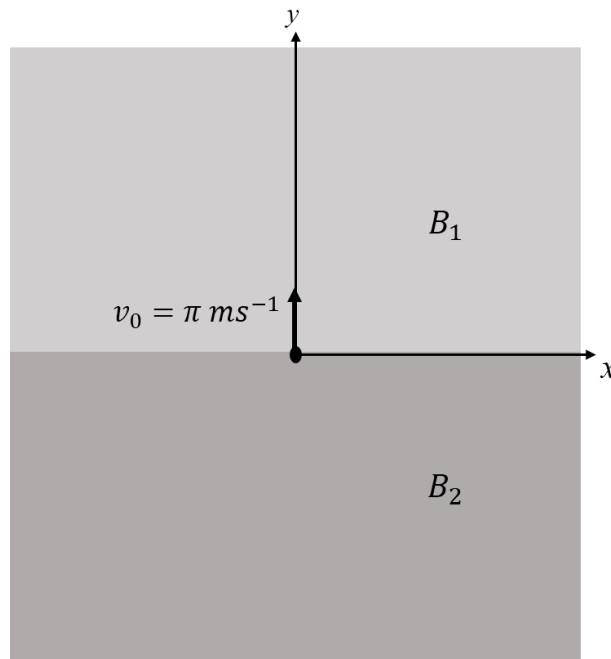

- Q.13 Sunlight of intensity $1.3 kW m^{-2}$ is incident normally on a thin convex lens of focal length $20 cm$. Ignore the energy loss of light due to the lens and assume that the lens aperture size is much smaller than its focal length. The average intensity of light, in $kW m^{-2}$, at a distance $22 cm$ from the lens on the other side is _____.

- Q.14 Two conducting cylinders of equal length but different radii are connected in series between two heat baths kept at temperatures $T_1 = 300\text{ K}$ and $T_2 = 100\text{ K}$, as shown in the figure. The radius of the bigger cylinder is twice that of the smaller one and the thermal conductivities of the materials of the smaller and the larger cylinders are K_1 and K_2 respectively. If the temperature at the junction of the two cylinders in the steady state is 200 K , then $K_1/K_2 =$ _____.

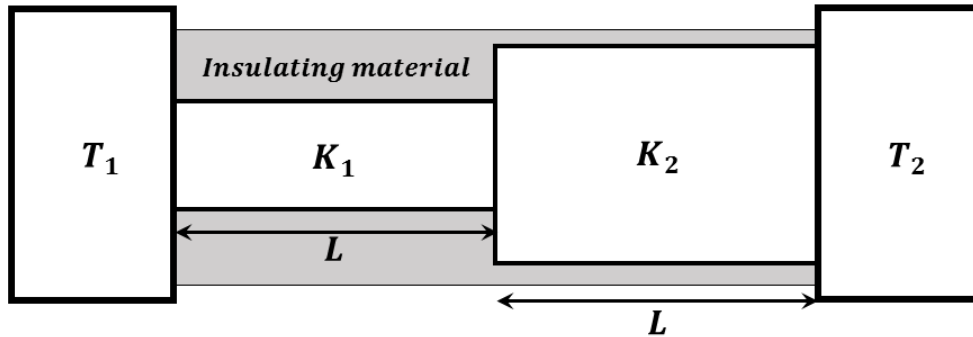

SECTION 3 (Maximum Marks: 12)

- This section contains **TWO (02)** paragraphs. Based on each paragraph, there are **TWO (02)** questions.
- Each question has **FOUR** options. **ONLY ONE** of these four options corresponds to the correct answer.
- For each question, choose the option corresponding to the correct answer.
- Answer to each question will be evaluated according to the following marking scheme:

Full Marks : +3 If **ONLY** the correct option is chosen.

Zero Marks : 0 If none of the options is chosen (i.e. the question is unanswered).

Negative Marks : -1 In all other cases.

PARAGRAPH "X"

In electromagnetic theory, the electric and magnetic phenomena are related to each other. Therefore, the dimensions of electric and magnetic quantities must also be related to each other. In the questions below, $[E]$ and $[B]$ stand for dimensions of electric and magnetic fields respectively, while $[\epsilon_0]$ and $[\mu_0]$ stand for dimensions of the permittivity and permeability of free space respectively. $[L]$ and $[T]$ are dimensions of length and time respectively. All the quantities are given in SI units.

(There are two questions based on PARAGRAPH "X", the question given below is one of them)

Q.15 The relation between $[E]$ and $[B]$ is

(A) $[E] = [B] [L] [T]$

(B) $[E] = [B] [L]^{-1} [T]$

(C) $[E] = [B] [L] [T]^{-1}$

(D) $[E] = [B] [L]^{-1} [T]^{-1}$

PARAGRAPH "X"

In electromagnetic theory, the electric and magnetic phenomena are related to each other. Therefore, the dimensions of electric and magnetic quantities must also be related to each other. In the questions below, $[E]$ and $[B]$ stand for dimensions of electric and magnetic fields respectively, while $[\epsilon_0]$ and $[\mu_0]$ stand for dimensions of the permittivity and permeability of free space respectively. $[L]$ and $[T]$ are dimensions of length and time respectively. All the quantities are given in SI units.

(There are two questions based on PARAGRAPH "X", the question given below is one of them)

Q.16 The relation between $[\epsilon_0]$ and $[\mu_0]$ is

(A) $[\mu_0] = [\epsilon_0] [L]^2 [T]^{-2}$

(B) $[\mu_0] = [\epsilon_0] [L]^{-2} [T]^2$

(C) $[\mu_0] = [\epsilon_0]^{-1} [L]^2 [T]^{-2}$

(D) $[\mu_0] = [\epsilon_0]^{-1} [L]^{-2} [T]^2$

PARAGRAPH "A"

If the measurement errors in all the independent quantities are known, then it is possible to determine the error in any dependent quantity. This is done by the use of series expansion and truncating the expansion at the first power of the error. For example, consider the relation $z = x/y$. If the errors in x , y and z are Δx , Δy and Δz , respectively, then

$$z \pm \Delta z = \frac{x \pm \Delta x}{y \pm \Delta y} = \frac{x}{y} \left(1 \pm \frac{\Delta x}{x}\right) \left(1 \pm \frac{\Delta y}{y}\right)^{-1}.$$

The series expansion for $\left(1 \pm \frac{\Delta y}{y}\right)^{-1}$, to first power in $\Delta y/y$, is $1 \mp (\Delta y/y)$. The relative errors in independent variables are always added. So the error in z will be

$$\Delta z = z \left(\frac{\Delta x}{x} + \frac{\Delta y}{y}\right).$$

The above derivation makes the assumption that $\Delta x/x \ll 1$, $\Delta y/y \ll 1$. Therefore, the higher powers of these quantities are neglected.

(There are two questions based on PARAGRAPH "A", the question given below is one of them)

- Q.17 Consider the ratio $r = \frac{(1-a)}{(1+a)}$ to be determined by measuring a dimensionless quantity a . If the error in the measurement of a is Δa ($\Delta a/a \ll 1$), then what is the error Δr in determining r ?

(A) $\frac{\Delta a}{(1+a)^2}$

(B) $\frac{2\Delta a}{(1+a)^2}$

(C) $\frac{2\Delta a}{(1-a^2)}$

(D) $\frac{2a\Delta a}{(1-a^2)}$

PARAGRAPH "A"

If the measurement errors in all the independent quantities are known, then it is possible to determine the error in any dependent quantity. This is done by the use of series expansion and truncating the expansion at the first power of the error. For example, consider the relation $z = x/y$. If the errors in x , y and z are Δx , Δy and Δz , respectively, then

$$z \pm \Delta z = \frac{x \pm \Delta x}{y \pm \Delta y} = \frac{x}{y} \left(1 \pm \frac{\Delta x}{x}\right) \left(1 \pm \frac{\Delta y}{y}\right)^{-1}.$$

The series expansion for $\left(1 \pm \frac{\Delta y}{y}\right)^{-1}$, to first power in $\Delta y/y$, is $1 \mp (\Delta y/y)$. The relative errors in independent variables are always added. So the error in z will be

$$\Delta z = z \left(\frac{\Delta x}{x} + \frac{\Delta y}{y}\right).$$

The above derivation makes the assumption that $\Delta x/x \ll 1$, $\Delta y/y \ll 1$. Therefore, the higher powers of these quantities are neglected.

(There are two questions based on PARAGRAPH "A", the question given below is one of them)

- Q.18 In an experiment the initial number of radioactive nuclei is 3000. It is found that 1000 ± 40 nuclei decayed in the first 1.0 s. For $|x| \ll 1$, $\ln(1 + x) = x$ up to first power in x . The error $\Delta\lambda$, in the determination of the decay constant λ , in s^{-1} , is

- (A) 0.04 (B) 0.03 (C) 0.02 (D) 0.01

JEE (ADVANCED) 2018 PAPER 1 PART II-CHEMISTRY

SECTION 1 (Maximum Marks: 24)

- This section contains **SIX (06)** questions.
- Each question has **FOUR** options for correct answer(s). **ONE OR MORE THAN ONE** of these four option(s) is (are) correct option(s).
- For each question, choose the correct option(s) to answer the question.
- Answer to each question will be evaluated according to the following marking scheme:
 - Full Marks* : +4 If only (all) the correct option(s) is (are) chosen.
 - Partial Marks* : +3 If all the four options are correct but **ONLY** three options are chosen.
 - Partial Marks* : +2 If three or more options are correct but **ONLY** two options are chosen, both of which are correct options.
 - Partial Marks* : +1 If two or more options are correct but **ONLY** one option is chosen and it is a correct option.
 - Zero Marks* : 0 If none of the options is chosen (i.e. the question is unanswered).
 - Negative Marks* : -2 In all other cases.
- **For Example:** If first, third and fourth are the **ONLY** three correct options for a question with second option being an incorrect option; selecting only all the three correct options will result in +4 marks. Selecting only two of the three correct options (e.g. the first and fourth options), without selecting any incorrect option (second option in this case), will result in +2 marks. Selecting only one of the three correct options (either first or third or fourth option), without selecting any incorrect option (second option in this case), will result in +1 marks. Selecting any incorrect option(s) (second option in this case), with or without selection of any correct option(s) will result in -2 marks.

Q.1 The compound(s) which generate(s) N_2 gas upon thermal decomposition below $300^\circ C$ is (are)

- (A) NH_4NO_3
- (B) $(NH_4)_2Cr_2O_7$
- (C) $Ba(N_3)_2$
- (D) Mg_3N_2

Q.2 The correct statement(s) regarding the binary transition metal carbonyl compounds is (are) (Atomic numbers: Fe = 26, Ni = 28)

- (A) Total number of valence shell electrons at metal centre in $Fe(CO)_5$ or $Ni(CO)_4$ is 16
- (B) These are predominantly low spin in nature
- (C) Metal-carbon bond strengthens when the oxidation state of the metal is lowered
- (D) The carbonyl C-O bond weakens when the oxidation state of the metal is increased

Q.3 Based on the compounds of group 15 elements, the correct statement(s) is (are)

- (A) Bi_2O_5 is more basic than N_2O_5
- (B) NF_3 is more covalent than BiF_3
- (C) PH_3 boils at lower temperature than NH_3
- (D) The N–N single bond is stronger than the P–P single bond

Q.4 In the following reaction sequence, the correct structure(s) of **X** is (are)

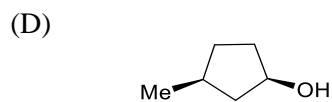
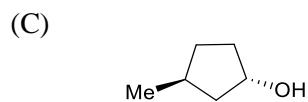
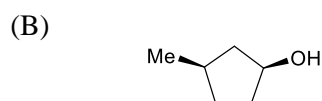
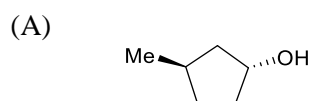
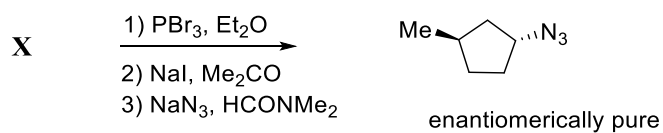

Q.5 The reaction(s) leading to the formation of 1,3,5-trimethylbenzene is (are)

(A)

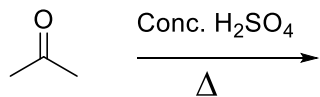

(B)

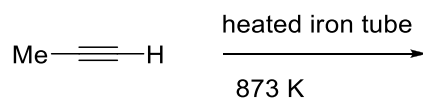

(C)

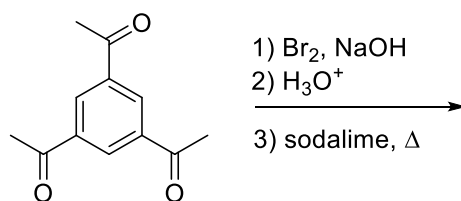

(D)

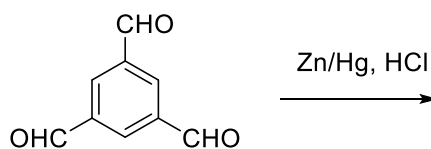

- Q.6 A reversible cyclic process for an ideal gas is shown below. Here, P , V , and T are pressure, volume and temperature, respectively. The thermodynamic parameters q , w , H and U are heat, work, enthalpy and internal energy, respectively.

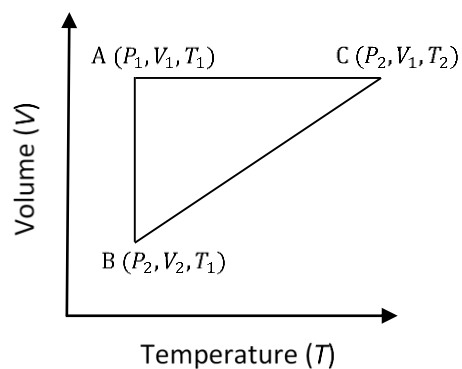

The correct option(s) is (are)

- (A) $q_{AC} = \Delta U_{BC}$ and $w_{AB} = P_2(V_2 - V_1)$
 (B) $w_{BC} = P_2(V_2 - V_1)$ and $q_{BC} = \Delta H_{AC}$
 (C) $\Delta H_{CA} < \Delta U_{CA}$ and $q_{AC} = \Delta U_{BC}$
 (D) $q_{BC} = \Delta H_{AC}$ and $\Delta H_{CA} > \Delta U_{CA}$

SECTION 2 (Maximum Marks: 24)

- This section contains **EIGHT (08)** questions. The answer to each question is a **NUMERICAL VALUE**.
- For each question, enter the correct numerical value (in decimal notation, truncated/rounded-off to the **second decimal place**; e.g. 6.25, 7.00, -0.33, -.30, 30.27, -127.30) using the mouse and the on-screen virtual numeric keypad in the place designated to enter the answer.
- Answer to each question will be evaluated according to the following marking scheme:
Full Marks : +3 If **ONLY** the correct numerical value is entered as answer.
Zero Marks : 0 In all other cases.

Q.7 Among the species given below, the total number of diamagnetic species is ____.

H atom, NO_2 monomer, O_2^- (superoxide), dimeric sulphur in vapour phase,
 Mn_3O_4 , $(\text{NH}_4)_2[\text{FeCl}_4]$, $(\text{NH}_4)_2[\text{NiCl}_4]$, K_2MnO_4 , K_2CrO_4

Q.8 The ammonia prepared by treating ammonium sulphate with calcium hydroxide is completely used by $\text{NiCl}_2 \cdot 6\text{H}_2\text{O}$ to form a stable coordination compound. Assume that both the reactions are 100% complete. If 1584 g of ammonium sulphate and 952 g of $\text{NiCl}_2 \cdot 6\text{H}_2\text{O}$ are used in the preparation, the combined weight (in grams) of gypsum and the nickel-ammonia coordination compound thus produced is ____.

(Atomic weights in g mol^{-1} : H = 1, N = 14, O = 16, S = 32, Cl = 35.5, Ca = 40, Ni = 59)

Q.9 Consider an ionic solid **MX** with NaCl structure. Construct a new structure (**Z**) whose unit cell is constructed from the unit cell of **MX** following the sequential instructions given below. Neglect the charge balance.

- (i) Remove all the anions (**X**) except the central one
- (ii) Replace all the face centered cations (**M**) by anions (**X**)
- (iii) Remove all the corner cations (**M**)
- (iv) Replace the central anion (**X**) with cation (**M**)

The value of $\left(\frac{\text{number of anions}}{\text{number of cations}}\right)$ in **Z** is _____ .

Q.10 For the electrochemical cell,

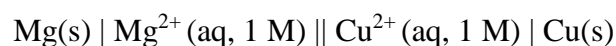

the standard emf of the cell is 2.70 V at 300 K. When the concentration of Mg^{2+} is changed to x M, the cell potential changes to 2.67 V at 300 K. The value of x is _____.

(given, $\frac{F}{R} = 11500 \text{ K V}^{-1}$, where F is the Faraday constant and R is the gas constant,

$\ln(10) = 2.30$)

- Q.11 A closed tank has two compartments **A** and **B**, both filled with oxygen (assumed to be ideal gas). The partition separating the two compartments is fixed and is a perfect heat insulator (Figure 1). If the old partition is replaced by a new partition which can slide and conduct heat but does **NOT** allow the gas to leak across (Figure 2), the volume (in m^3) of the compartment **A** after the system attains equilibrium is _____.

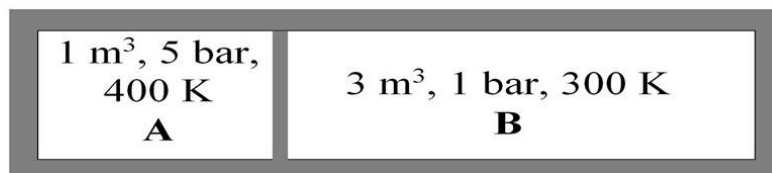

Figure 1

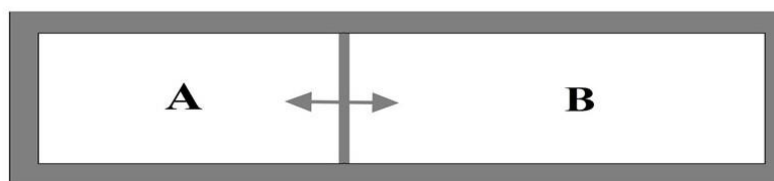
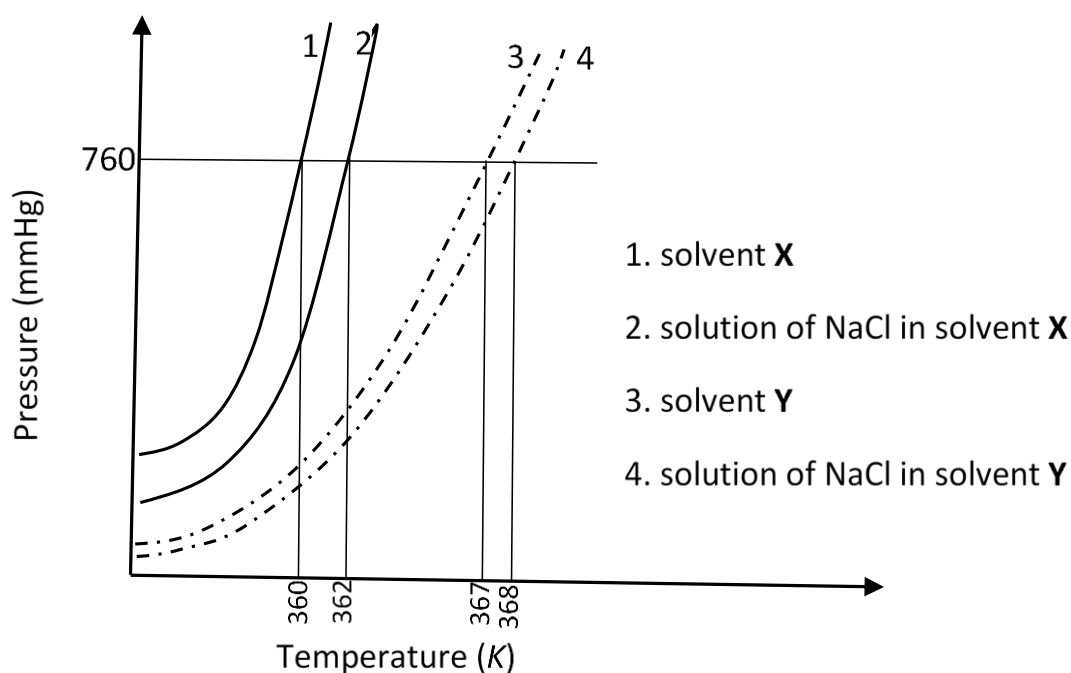

Figure 2

- Q.12 Liquids **A** and **B** form ideal solution over the entire range of composition. At temperature T , equimolar binary solution of liquids **A** and **B** has vapour pressure 45 Torr. At the same temperature, a new solution of **A** and **B** having mole fractions x_A and x_B , respectively, has vapour pressure of 22.5 Torr. The value of x_A/x_B in the new solution is _____ .
(given that the vapour pressure of pure liquid **A** is 20 Torr at temperature T)

- Q.13 The solubility of a salt of weak acid (**AB**) at pH 3 is $Y \times 10^{-3} \text{ mol L}^{-1}$. The value of **Y** is _____.
(Given that the value of solubility product of **AB** (K_{sp}) = 2×10^{-10} and the value of ionization constant of **HB** (K_a) = 1×10^{-8})

- Q.14 The plot given below shows $P - T$ curves (where P is the pressure and T is the temperature) for two solvents **X** and **Y** and isomolal solutions of NaCl in these solvents. NaCl completely dissociates in both the solvents.



On addition of equal number of moles of a non-volatile solute **S** in equal amount (in kg) of these solvents, the elevation of boiling point of solvent **X** is three times that of solvent **Y**. Solute **S** is known to undergo dimerization in these solvents. If the degree of dimerization is 0.7 in solvent **Y**, the degree of dimerization in solvent **X** is _____.

SECTION 3 (Maximum Marks: 12)

- This section contains **TWO (02)** paragraphs. Based on each paragraph, there are **TWO (02)** questions.
- Each question has **FOUR** options. **ONLY ONE** of these four options corresponds to the correct answer.
- For each question, choose the option corresponding to the correct answer.
- Answer to each question will be evaluated according to the following marking scheme:
 - Full Marks* : +3 If **ONLY** the correct option is chosen.
 - Zero Marks* : 0 If none of the options is chosen (i.e. the question is unanswered).
 - Negative Marks* : -1 In all other cases.

PARAGRAPH "X"

Treatment of benzene with CO/HCl in the presence of anhydrous $\text{AlCl}_3/\text{CuCl}$ followed by reaction with $\text{Ac}_2\text{O}/\text{NaOAc}$ gives compound **X** as the major product. Compound **X** upon reaction with $\text{Br}_2/\text{Na}_2\text{CO}_3$, followed by heating at 473 K with moist KOH furnishes **Y** as the major product. Reaction of **X** with $\text{H}_2/\text{Pd-C}$, followed by H_3PO_4 treatment gives **Z** as the major product.

(There are two questions based on PARAGRAPH "X", the question given below is one of them)

Q.15 The compound **Y** is

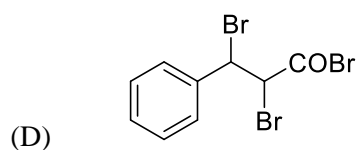
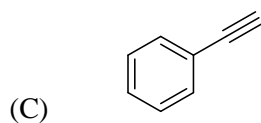
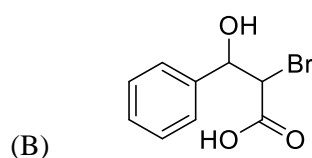
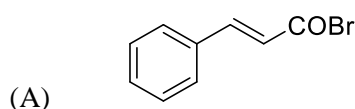

PARAGRAPH "X"

Treatment of benzene with CO/HCl in the presence of anhydrous $\text{AlCl}_3/\text{CuCl}$ followed by reaction with $\text{Ac}_2\text{O}/\text{NaOAc}$ gives compound **X** as the major product. Compound **X** upon reaction with $\text{Br}_2/\text{Na}_2\text{CO}_3$, followed by heating at 473 K with moist KOH furnishes **Y** as the major product. Reaction of **X** with $\text{H}_2/\text{Pd-C}$, followed by H_3PO_4 treatment gives **Z** as the major product.

(There are two questions based on PARAGRAPH "X", the question given below is one of them)

Q.16 The compound **Z** is

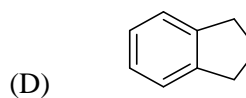
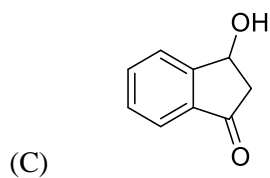
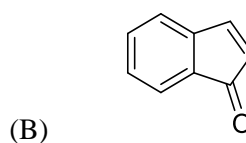
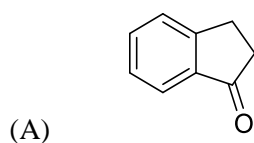

PARAGRAPH "A"

An organic acid **P** ($C_{11}H_{12}O_2$) can easily be oxidized to a dibasic acid which reacts with ethyleneglycol to produce a polymer dacron. Upon ozonolysis, **P** gives an aliphatic ketone as one of the products. **P** undergoes the following reaction sequences to furnish **R** via **Q**. The compound **P** also undergoes another set of reactions to produce **S**.

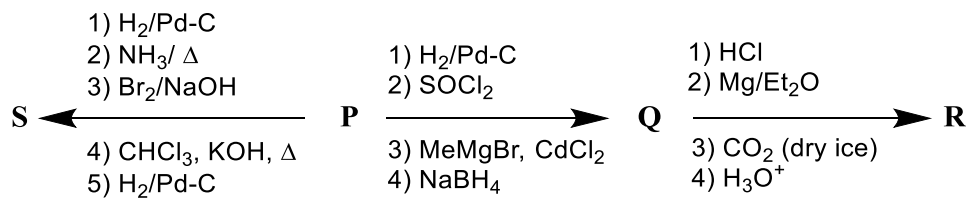

(There are two questions based on PARAGRAPH "A", the question given below is one of them)

Q.17 The compound **R** is

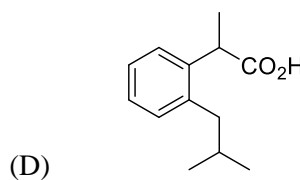
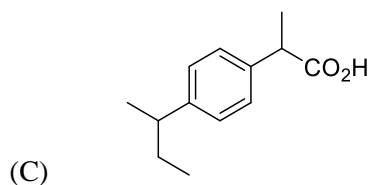
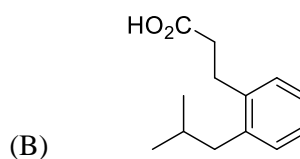
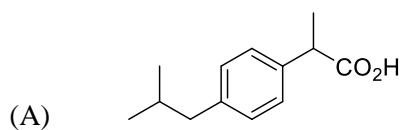

PARAGRAPH "A"

An organic acid **P** ($C_{11}H_{12}O_2$) can easily be oxidized to a dibasic acid which reacts with ethyleneglycol to produce a polymer dacron. Upon ozonolysis, **P** gives an aliphatic ketone as one of the products. **P** undergoes the following reaction sequences to furnish **R** via **Q**. The compound **P** also undergoes another set of reactions to produce **S**.

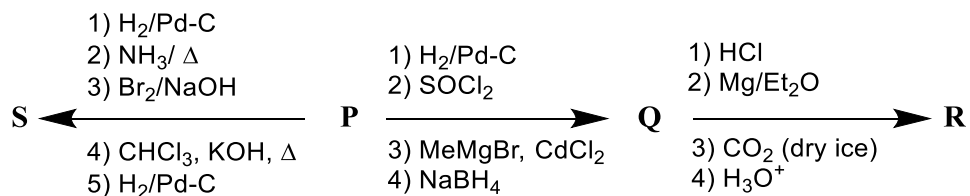

(There are two questions based on PARAGRAPH "A", the question given below is one of them)

Q.18 The compound **S** is

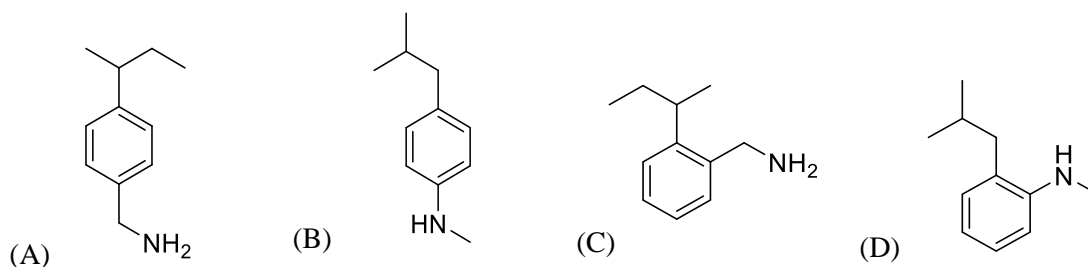

JEE (ADVANCED) 2018 PAPER 1

PART-III MATHEMATICS

SECTION 1 (Maximum Marks: 24)

- This section contains **SIX (06)** questions.
- Each question has **FOUR** options for correct answer(s). **ONE OR MORE THAN ONE** of these four option(s) is (are) correct option(s).
- For each question, choose the correct option(s) to answer the question.
- Answer to each question will be evaluated according to the following marking scheme:
 - Full Marks* : +4 If only (all) the correct option(s) is (are) chosen.
 - Partial Marks* : +3 If all the four options are correct but **ONLY** three options are chosen.
 - Partial Marks* : +2 If three or more options are correct but **ONLY** two options are chosen, both of which are correct options.
 - Partial Marks* : +1 If two or more options are correct but **ONLY** one option is chosen and it is a correct option.
 - Zero Marks* : 0 If none of the options is chosen (i.e. the question is unanswered).
 - Negative Marks* : -2 In all other cases.
- **For Example:** If first, third and fourth are the **ONLY** three correct options for a question with second option being an incorrect option; selecting only all the three correct options will result in +4 marks. Selecting only two of the three correct options (e.g. the first and fourth options), without selecting any incorrect option (second option in this case), will result in +2 marks. Selecting only one of the three correct options (either first or third or fourth option) , without selecting any incorrect option (second option in this case), will result in +1 marks. Selecting any incorrect option(s) (second option in this case), with or without selection of any correct option(s) will result in -2 marks.

Q.1 For a non-zero complex number z , let $\arg(z)$ denote the principal argument with $-\pi < \arg(z) \leq \pi$. Then, which of the following statement(s) is (are) **FALSE**?

(A) $\arg(-1 - i) = \frac{\pi}{4}$, where $i = \sqrt{-1}$

(B) The function $f: \mathbb{R} \rightarrow (-\pi, \pi]$, defined by $f(t) = \arg(-1 + it)$ for all $t \in \mathbb{R}$, is continuous at all points of \mathbb{R} , where $i = \sqrt{-1}$

(C) For any two non-zero complex numbers z_1 and z_2 ,

$$\arg\left(\frac{z_1}{z_2}\right) = \arg(z_1) - \arg(z_2)$$

is an integer multiple of 2π

(D) For any three given distinct complex numbers z_1 , z_2 and z_3 , the locus of the point z satisfying the condition

$$\arg\left(\frac{(z-z_1)(z_2-z_3)}{(z-z_3)(z_2-z_1)}\right) = \pi,$$

lies on a straight line

Q.2 In a triangle PQR , let $\angle PQR = 30^\circ$ and the sides PQ and QR have lengths $10\sqrt{3}$ and 10, respectively. Then, which of the following statement(s) is (are) **TRUE**?

(A) $\angle QPR = 45^\circ$

(B) The area of the triangle PQR is $25\sqrt{3}$ and $\angle QRP = 120^\circ$

(C) The radius of the incircle of the triangle PQR is $10\sqrt{3} - 15$

(D) The area of the circumcircle of the triangle PQR is 100π

Q.3 Let $P_1: 2x + y - z = 3$ and $P_2: x + 2y + z = 2$ be two planes. Then, which of the following statement(s) is (are) TRUE?

(A) The line of intersection of P_1 and P_2 has direction ratios 1, 2, -1

(B) The line

$$\frac{3x - 4}{9} = \frac{1 - 3y}{9} = \frac{z}{3}$$

is perpendicular to the line of intersection of P_1 and P_2

(C) The acute angle between P_1 and P_2 is 60°

(D) If P_3 is the plane passing through the point $(4, 2, -2)$ and perpendicular to the line of intersection of P_1 and P_2 , then the distance of the point $(2, 1, 1)$ from the plane

$$P_3 \text{ is } \frac{2}{\sqrt{3}}$$

Q.4 For every twice differentiable function $f: \mathbb{R} \rightarrow [-2, 2]$ with $(f(0))^2 + (f'(0))^2 = 85$, which of the following statement(s) is (are) TRUE?

(A) There exist $r, s \in \mathbb{R}$, where $r < s$, such that f is one-one on the open interval (r, s)

(B) There exists $x_0 \in (-4, 0)$ such that $|f'(x_0)| \leq 1$

(C) $\lim_{x \rightarrow \infty} f(x) = 1$

(D) There exists $\alpha \in (-4, 4)$ such that $f(\alpha) + f''(\alpha) = 0$ and $f'(\alpha) \neq 0$

Q.5 Let $f: \mathbb{R} \rightarrow \mathbb{R}$ and $g: \mathbb{R} \rightarrow \mathbb{R}$ be two non-constant differentiable functions. If

$$f'(x) = (e^{(f(x)-g(x))})g'(x) \text{ for all } x \in \mathbb{R},$$

and $f(1) = g(2) = 1$, then which of the following statement(s) is (are) TRUE?

(A) $f(2) < 1 - \log_e 2$

(B) $f(2) > 1 - \log_e 2$

(C) $g(1) > 1 - \log_e 2$

(D) $g(1) < 1 - \log_e 2$

Q.6 Let $f: [0, \infty) \rightarrow \mathbb{R}$ be a continuous function such that

$$f(x) = 1 - 2x + \int_0^x e^{x-t} f(t) dt$$

for all $x \in [0, \infty)$. Then, which of the following statement(s) is (are) TRUE?

(A) The curve $y = f(x)$ passes through the point $(1, 2)$

(B) The curve $y = f(x)$ passes through the point $(2, -1)$

(C) The area of the region $\{(x, y) \in [0, 1] \times \mathbb{R} : f(x) \leq y \leq \sqrt{1-x^2}\}$ is $\frac{\pi-2}{4}$

(D) The area of the region $\{(x, y) \in [0, 1] \times \mathbb{R} : f(x) \leq y \leq \sqrt{1-x^2}\}$ is $\frac{\pi-1}{4}$

SECTION 2 (Maximum Marks: 24)

- This section contains **EIGHT (08)** questions. The answer to each question is a **NUMERICAL VALUE**.
- For each question, enter the correct numerical value (in decimal notation, truncated/rounded-off to the **second decimal place**; e.g. 6.25, 7.00, -0.33, -.30, 30.27, -127.30) using the mouse and the on-screen virtual numeric keypad in the place designated to enter the answer.
- Answer to each question will be evaluated according to the following marking scheme:
Full Marks : +3 If **ONLY** the correct numerical value is entered as answer.
Zero Marks : 0 In all other cases.

Q.7 The value of

$$((\log_2 9)^2)^{\frac{1}{\log_2 (\log_2 9)}} \times (\sqrt{7})^{\frac{1}{\log_4 7}}$$

is _____ .

Q.8 The number of 5 digit numbers which are divisible by 4, with digits from the set $\{1, 2, 3, 4, 5\}$ and the repetition of digits is allowed, is _____ .

Q.9 Let X be the set consisting of the first 2018 terms of the arithmetic progression 1, 6, 11, ..., and Y be the set consisting of the first 2018 terms of the arithmetic progression 9, 16, 23, Then, the number of elements in the set $X \cup Y$ is _____ .

Q.10 The number of real solutions of the equation

$$\sin^{-1} \left(\sum_{i=1}^{\infty} x^{i+1} - x \sum_{i=1}^{\infty} \left(\frac{x}{2}\right)^i \right) = \frac{\pi}{2} - \cos^{-1} \left(\sum_{i=1}^{\infty} \left(-\frac{x}{2}\right)^i - \sum_{i=1}^{\infty} (-x)^i \right)$$

lying in the interval $\left(-\frac{1}{2}, \frac{1}{2}\right)$ is _____ .

(Here, the inverse trigonometric functions $\sin^{-1}x$ and $\cos^{-1}x$ assume values in $\left[-\frac{\pi}{2}, \frac{\pi}{2}\right]$ and $[0, \pi]$, respectively.)

Q.11 For each positive integer n , let

$$y_n = \frac{1}{n} \left((n+1)(n+2) \cdots (n+n) \right)^{\frac{1}{n}}$$

For $x \in \mathbb{R}$, let $[x]$ be the greatest integer less than or equal to x . If $\lim_{n \rightarrow \infty} y_n = L$, then the value of $[L]$ is _____ .

Q.12 Let \vec{a} and \vec{b} be two unit vectors such that $\vec{a} \cdot \vec{b} = 0$. For some $x, y \in \mathbb{R}$, let $\vec{c} = x\vec{a} + y\vec{b} + (\vec{a} \times \vec{b})$. If $|\vec{c}| = 2$ and the vector \vec{c} is inclined at the same angle α to both \vec{a} and \vec{b} , then the value of $8 \cos^2 \alpha$ is _____ .

Q.13 Let a, b, c be three non-zero real numbers such that the equation

$$\sqrt{3} a \cos x + 2 b \sin x = c, \quad x \in \left[-\frac{\pi}{2}, \frac{\pi}{2}\right],$$

has two distinct real roots α and β with $\alpha + \beta = \frac{\pi}{3}$. Then, the value of $\frac{b}{a}$ is _____ .

Q.14 A farmer F_1 has a land in the shape of a triangle with vertices at $P(0, 0)$, $Q(1, 1)$ and $R(2, 0)$. From this land, a neighbouring farmer F_2 takes away the region which lies between the side PQ and a curve of the form $y = x^n$ ($n > 1$). If the area of the region taken away by the farmer F_2 is exactly 30% of the area of ΔPQR , then the value of n is _____ .

SECTION 3 (Maximum Marks: 12)

- This section contains **TWO (02)** paragraphs. Based on each paragraph, there are **TWO (02)** questions.
- Each question has **FOUR** options. **ONLY ONE** of these four options corresponds to the correct answer.
- For each question, choose the option corresponding to the correct answer.
- Answer to each question will be evaluated according to the following marking scheme:
Full Marks : +3 If **ONLY** the correct option is chosen.
Zero Marks : 0 If none of the options is chosen (i.e. the question is unanswered).
Negative Marks : -1 In all other cases.

PARAGRAPH "X"

Let S be the circle in the xy -plane defined by the equation $x^2 + y^2 = 4$.

(There are two questions based on PARAGRAPH "X", the question given below is one of them)

- Q.15 Let E_1E_2 and F_1F_2 be the chords of S passing through the point $P_0(1, 1)$ and parallel to the x -axis and the y -axis, respectively. Let G_1G_2 be the chord of S passing through P_0 and having slope -1 . Let the tangents to S at E_1 and E_2 meet at E_3 , the tangents to S at F_1 and F_2 meet at F_3 , and the tangents to S at G_1 and G_2 meet at G_3 . Then, the points E_3 , F_3 , and G_3 lie on the curve
- (A) $x + y = 4$ (B) $(x - 4)^2 + (y - 4)^2 = 16$
 (C) $(x - 4)(y - 4) = 4$ (D) $xy = 4$

PARAGRAPH "X"

Let S be the circle in the xy -plane defined by the equation $x^2 + y^2 = 4$.

(There are two questions based on PARAGRAPH "X", the question given below is one of them)

- Q.16 Let P be a point on the circle S with both coordinates being positive. Let the tangent to S at P intersect the coordinate axes at the points M and N . Then, the mid-point of the line segment MN must lie on the curve
- (A) $(x + y)^2 = 3xy$ (B) $x^{2/3} + y^{2/3} = 2^{4/3}$
 (C) $x^2 + y^2 = 2xy$ (D) $x^2 + y^2 = x^2 y^2$

PARAGRAPH "A"

There are five students S_1, S_2, S_3, S_4 and S_5 in a music class and for them there are five seats R_1, R_2, R_3, R_4 and R_5 arranged in a row, where initially the seat R_i is allotted to the student $S_i, i = 1, 2, 3, 4, 5$. But, on the examination day, the five students are randomly allotted the five seats.

(There are two questions based on PARAGRAPH "A", the question given below is one of them)

Q.17 The probability that, on the examination day, the student S_1 gets the previously allotted seat R_1 , and **NONE** of the remaining students gets the seat previously allotted to him/her is

- (A) $\frac{3}{40}$ (B) $\frac{1}{8}$ (C) $\frac{7}{40}$ (D) $\frac{1}{5}$

PARAGRAPH "A"

There are five students S_1, S_2, S_3, S_4 and S_5 in a music class and for them there are five seats R_1, R_2, R_3, R_4 and R_5 arranged in a row, where initially the seat R_i is allotted to the student $S_i, i = 1, 2, 3, 4, 5$. But, on the examination day, the five students are randomly allotted the five seats.

(There are two questions based on PARAGRAPH "A", the question given below is one of them)

Q.18 For $i = 1, 2, 3, 4$, let T_i denote the event that the students S_i and S_{i+1} do **NOT** sit adjacent to each other on the day of the examination. Then, the probability of the event $T_1 \cap T_2 \cap T_3 \cap T_4$ is

- (A) $\frac{1}{15}$ (B) $\frac{1}{10}$ (C) $\frac{7}{60}$ (D) $\frac{1}{5}$

END OF THE QUESTION PAPER