

Electronics-Engineering

PRACTICE SET-2

1. In the circuit shown in the figure given below, RC is very small and L/R is very large when compared to the time period of the various input signals. Also $R \ll R_3$

The output $V_0(t)$ is given by

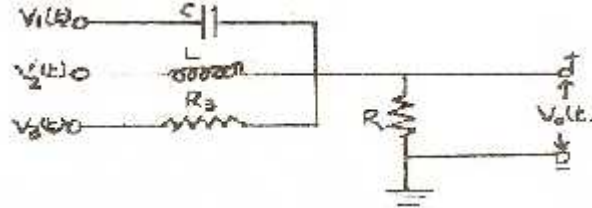

- A. $\frac{dv_1(t)}{dt} + \int v_2(t) dt + \frac{R}{R_3} v_3(t)$
- B. $\int V_1(t) dt + \frac{dv_2(t)}{dt} + \frac{R}{R_3} \int v_3(t) dt$
- C. $RC \frac{dv_1(t)}{dt} + \frac{1}{L/R} \int v_2(t) dt + \frac{R}{R_3} v_3(t)$
- D. $RC \int V_1(t) dt + \frac{1}{L/R} \int v_2(t) dt + \frac{R}{R_3} v_3(t)$
2. Transmission of power to a load over a transmission line achieves optimum value when standing-wave ratio (SWR) becomes
- A. 2 : 1
- B. 1 : 2
- C. 1 : 1
- D. 1 : $\sqrt{2}$
3. In resonant pulse inverters
- A. dc output voltage variation is wide
- B. the frequency is low
- C. the output voltage is never sinusoidal
- D. dc saturation of transformer core is minimised
4. A 10 V full-scale voltmeter having 100 k-ohm / V sensitivity is used to measure the output of a photovoltaic cell having an internal resistance of 1 M-ohm. The voltmeter reads 5V. The voltage generated by the photovoltaic cell is
- A. 5 V
- B. 10 V
- C. greater than 5 V but less than 10 V
- D. greater than 10 V
5. Match List-I with List-II and select the correct answer using the codes given below the lists:

List-I
(Transfer Function)

A. $\frac{1}{(s + \alpha)(s + \beta)}$

B. $\frac{1}{(s - \alpha)(s - \beta)}$

C. $\frac{1}{(s - \alpha + j\beta)(\alpha - \alpha - j\beta)}$

D. $\frac{1}{s + \alpha + j\beta)(s + \alpha - j\beta)}$

List-II
(Transient Response)

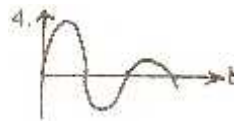
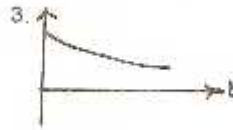
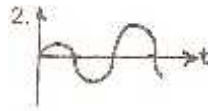
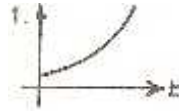

Assume $\alpha > 0$ and $\beta > 0$

Codes:

	A	B	C	D
A.	1	3	2	4
B.	3	1	2	4
C.	2	1	4	3
D.	4	2	1	3

6. A computer system has a 4K word cache organized in block set associative manner with 4 blocks per set, 64 words per block. The number of bits in the SET and WORD fields of the main memory address formula is
- A. 15, 4
 B. 6, 4
 C. 7, 2
 D. 4, 6
7. In figure shown below, which component in the battery charging circuit is wrongly connected?

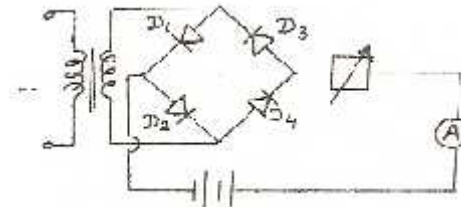

- A. Battery.
 - B. Control resistor.
 - C. Rectifier diodes.
 - D. Transformer.
8. A carrier is simultaneously modulated by sine wave with modulation indices of 30% and 40% respectively. The overall modulation index will be
- A. 50%
 - B. 70%
 - C. 100%
 - D. indefinite as modulation by two waves simultaneously is not possible.
9. In an 8085 microprocessor system with memory mapped I / O
- A. I / O devices have 16-bit addresses
 - B. I / O devices are accessed using IN and OUT instructions
 - C. there can be a maximum of 256 input devices and 256 output devices
 - D. arithmetic and logic operations can be directly performed with the I / O data.
10. Low grade fuels have
- A. low moisture content
 - B. low ash content
 - C. low calorific value
 - D. low carbon content
11. Aluminum has a higher atomic packing factor than molybdenum by about 6%. This means that
- A. Aluminum is heavier than molybdenum
 - B. the ratio of the volume of the unit cell to the volume of the atoms per unit cell is lower in aluminum
 - C. The ratio of the number of atoms per unit cell to size of the cell is roughly equal to Both
 - D. The distance between atoms are equal for both
12. A microwave junction is supposed to be matched at all ports if in the S matrix
- A. all the diagonal elements are zero
 - B. all the diagonal elements are equal but not zero
 - C. all the diagonal elements are complex
 - D. is Hermitian
13. Radar becons are used for
- A. target identification
 - B. navigation
 - C. causing significant extensions of the maximum range
 - D. all of these
14. Which of the following statements is / are correct?
- A. All the resonant frequencies of a microwave cavity are harmonics of a single

frequency

- B. No two of the resonant frequencies of a microwave cavity are harmonics of a single frequency
- C. Resonant frequencies of a microwave cavity form distinct sets of harmonically related frequencies
- D. None of the above, because a microwave cavity does not resonate at a number of frequencies.
15. Satellite repeater serves to
- A. to receive signal from the satellite
- B. to repeat the satellite signals received
- C. to change the frequency of signals received from the repeater
- D. none of these
16. For the circuit shown in figure below, match List-I with List-II and select the correct answer using the codes given below the lists:

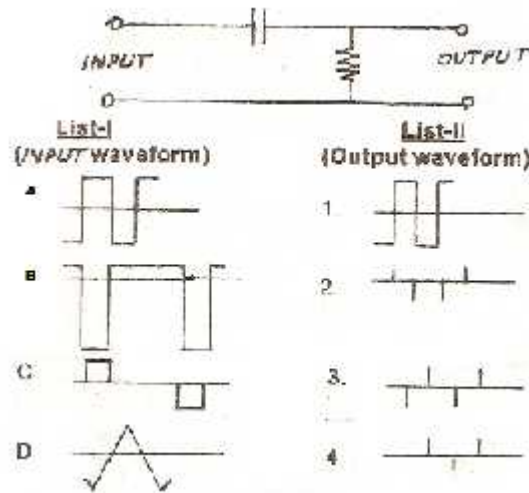

Codes:

- | | A | B | C | D |
|----|---|---|---|---|
| A. | 4 | 3 | 2 | 1 |
| B. | 1 | 2 | 3 | 4 |
| C. | 2 | 3 | 4 | 1 |
| D. | 4 | 3 | 1 | 2 |
17. The relationship between SWR and K_r of a transmission line is

A. $SWR = \frac{K_r + 1}{K_r - 1}$

B. $SWR = \frac{1 - K_r}{1 + K_r}$

$$C. SWR = \frac{1 + K_r}{1 - K_r}$$

$$D. SWR = \frac{K_r^2 + 1}{1 - K_r^2}$$

18. The speed and torque of induction motor can be varied by which of the following means
1. Stator voltage control
 2. Rotor voltage control
 3. Frequency control
- A. 1 only
 B. 2 only
 C. 1 and 2 only
 D. 1, 2 and 3.
19. A 2 V peak to peak symmetrical wave is given to a rectifier type ac voltmeter. The voltmeter will read
- A. 2.22 V
 B. 1.11 V
 C. 1 V
 D. zero
20. A control system whose step response is $-0.5(1 + e^{-2t})$ is cascaded to another control block whose impulse response is e^{-t} . The transfer function of the cascaded combination is:
- A. $\frac{1}{(s+1)(s+2)}$
 B. $\frac{1}{s(s+1)}$
 C. $\frac{1}{s(s+2)}$
 D. $\frac{0.5}{(s+1)(s+2)}$
21. For the logic circuit shown in figure below, the output Y is equal to

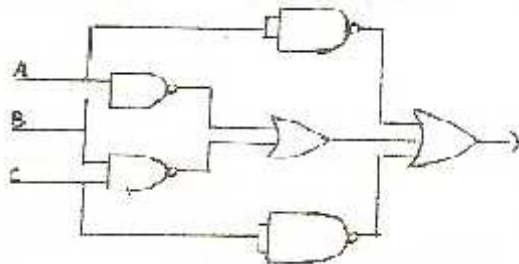

- A. \overline{ABC}
 B. $\overline{A} + \overline{B} + \overline{C}$

C. $\overline{AB} + \overline{BC} + \overline{A} + \overline{C}$

D. $\overline{AB} + \overline{BC}$

22. A full wave peak rectifier (using capacitor input filter) has a percentage ripple of 2 and load resistance of 10 k-ohms. Minimum filter capacitance, in μF , required is
- A. 12
 B. 50
 C. 24
 D. 100
23. The intermediate frequency of a superheat receiver is 450 KHz. If it is tuned to 1200 KHz, the image frequency will be
- A. 750 KHz
 B. 900 KHz
 C. 1650 KHz
 D. 2100 KHz
24. The following program is run on an 8085 microprocessor:

Memory Address in hex	Instruction
2000	LXI SP, 1000
2003	PUSH H
2004	PUSH D
2005	CALL 2050
2008	POP H
2009	HLT

At the completion of execution of the program, the program Counter of the 8085 contains And the Stack Pointer contains

- A. 2050, OFFC
 B. 2020, OCCF
 C. 2000, CCFC
 D. 2020, OFFC
25. A student would like to separate the various components of a sample of ink in the laboratory. Which of the following techniques would be most suitable for him to use ?
- A. Filtration
 B. Distillation
 C. Titration
 D. Paper chromatography.
26. The nature of atomic bond found in diamond is
- A. ionic
 B. covalent
 C. metallic

- D. none of the above
27. Waveguides are pressurized above normal atmospheric pressure for
- increasing their power handling capacity
 - improving the conductivity of their walls
 - preventing higher order modes from propagating
 - varying the wave impedance
28. The Doppler Effect is used in
- Pulsed Radar
 - CW Radar
 - MTI
 - both (a) and (c)
29. Two dissimilar antennas having their maximum directivities equal.
- must have their beam widths also equal
 - cannot have their beam widths equal because they are dissimilar antennas
 - may not necessarily have their maximum power gains equal
 - must have their effective aperture areas (capture areas) also equal.
30. A satellite earth station has
- only transmitting equipment
 - only receiving equipment
 - both transmitting as well as receiving equipment
 - none of these
31. Assertion (A): In the given network, the source is delivering maximum power.



Reason (R): Z_L is the complex of Z_g .

32. The reflection coefficient, characteristic impedance and load impedance of a transmission line are connected together by the relation
- $K_r = \frac{Z_L + Z_0}{Z_0 - Z_L}$
 - $K_r = \frac{Z_0 Z_L}{Z_0 - Z_L}$
 - $K_r = \frac{Z_L - Z_0}{Z_L + Z_0}$
 - $K_r = \frac{Z_L - Z_0}{Z_0 Z_L}$
33. Static induction thyristors have

- A. high dv / dt and low di / dt
 B. low dv / dt and high di / dt
 C. low dv / dt and low di / dt
 D. high dv / dt and high di / dt
34. An advantage of a permanent magnet moving coil instrument is that it is
 A. free from friction error
 B. has high (torque / weight of the moving parts) ratio
 C. has low (torque / weight of moving parts) ratio
 D. can be used on both a.c. and d.c.

35. The error response of a second order system to a step input is obtained as

$$E(t) = 1.66 e^{-st} \sin(6t + 37^\circ).$$

The damping ratio is

- A. 0.4
 B. 0.5
 C. 0.8
 D. 1.0
36. The logic realized by the circuit shown in figure below, is

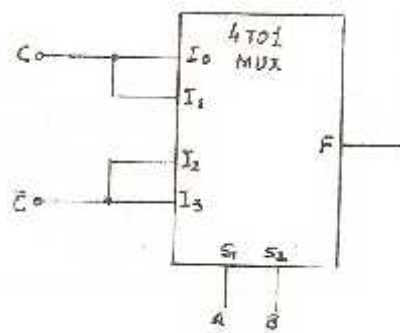

- A. $F = A \odot C$
 B. $F = A \oplus C$
 C. $F = B \odot C$
 D. $F = B \oplus C$
37. A zener regulator has an input voltage from 16 to 20 V and a load current from 25 to 100 mA. Breakdown voltage $V = 12$ V. For holding load voltage constant under all conditions, the value of series limiting resistor should be
 A. 1600 ohms
 B. 40 ohms
 C. 160 ohms
 D. 200 ohms
38. The filter required to obtain SSB from DSB signal is
 A. low pass filter
 B. high - pass filter

- C. band - pass filter
 - D. band - stop filter
39. When a CPU is interrupted, it
- A. stops execution of instructions
 - B. acknowledges interrupt and branches to a subroutine
 - C. acknowledges interrupt and continues
 - D. acknowledges interrupt and waits for the next instruction from the interrupting device.
40. Which of the following statements concerning the pH meter is / are correct?
- I. The pH meter may be used to measure the acidity (for alkalinity) of a solution.
 - II. The pH meter must consist of at least a reference electrode, an indicating electrode and a potential measuring meter
 - III. The potential of a reference electrode of a pH meter depends largely upon the hydrogen ion concentration of the measured solution.
- A. I only
 - B. I and II
 - C. III only
 - D. I and III only
41. The crystal structure of most of the common metals is
- A. hexagonal
 - B. covalent
 - C. orthorhombic
 - D. none of the above
42. Interleaving in colour TV system implies
- A. mixing colour information with black and white signals
 - B. extracting black and white signals from colour signals
 - C. converting black and white signals into colour signals
 - D. producing I and Q signals.
43. Flat topped rectangular pulses are used in Radar Transmitters to
- A. allow good minimum range and accurate range transmission
 - B. prevent frequency changes in magnetron
 - C. get better echo's free from noise
 - D. both (a) and (b)
44. The beam width-between first-nulls of a uniform linear array of N equally-spaced (element spacing = b), equally-excited antennas, is determined by
- A. N alone and not be d
 - B. d alone and not be N
 - C. the ratio, (N / d)
 - D. the product, (Nd)
45. A satellite earth station
- A. has only receiving equipment

- B. transmitting equipment
C. (a) and (b) above
D. none of these
46. A relation over the set $s = (x, y, z)$ is defined by $(x, x), (x, y), (y, x), (x, z), (y, z), (y, y), (z, z)$
What properties hold for this relation?
I. Symmetry
II. Reflexivity
III. Antisymmetry
IV. Irreflexivity.
A. I only
B. II only
C. I and II
D. I and IV.
47. A saw-tooth generator is built using a UJT with a constant current-charged capacitor C of $1 \mu\text{F}$ driving the emitter. If the voltage V_{BB} is 15 V and the capacitor charging current is 1 mA , then the period of the saw-tooth is approximately
A. 10 ms
B. 1 ms
C. 0.1 ms
D. 0.01 ms
48. Consider the following communication systems
1. Technology
2. Radio communication
3. Microwave communication
4. Optical sequence of these systems from the point of view of increase of base band channels each one of them can accommodate is
A. 2, 4, 3, 1
B. 3, 4, 1, 2
C. 1, 2, 3, 4
D. 4, 2, 1, 3
49. The number of bits needed to address 4K memory is
A. 6
B. 8
C. 12
D. 16
50. Three rods one made of glass, one of pure aluminum and one made of wrought iron are heated to 150°C . All the rods are 15 mm in diameter and 300 mm long. The lowest temperature at the free end of the rods will occur in case of
A. Aluminum rod

- B. Wrought iron rod
- C. Glass rod
- D. Temperature will be same for all the three rods at free.

Solution

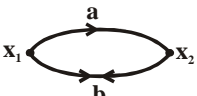
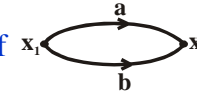
- 1.(D). The networks having identical driving point functions are N1 and N4.
- 2.(D). The m.k.s. unit of electric field E is ampere per meter.
- 3.(B). The current-source inverter (CSI) is a dual of a voltage-source inverter (VSI). The line-to-line voltage of a VSI is similar in shape to the line current of a CSI. The advantages of the CSI are:
 1. Since the input dc current is controlled and limited, misfiring of switching devices, or a short circuit, would not be serious problems;
 2. The peak current of power devices is limited;
 3. The commutation circuits for thyristors are simpler; and
 4. It has the ability to handle reactive or regenerative load without freewheeling diodes.
- 4.(D). $W_1 = 100 \text{ W} \pm 1 \text{ W}$;
 $W_2 = -50 \pm 0.5 \text{ W}$
 $\therefore W_1 + W_2 = 50 \pm \frac{1.5}{50} \times 100 = \pm 3\%$.
- 5.(C). The transfer function of  is $\frac{a}{1-ab}$ and that of  is $(a + b)$.
- 6.(D). Recursive programs take more time than the equivalent non-recursive version and hence not efficient. This is because to the function call overhead. In binary search since every time the current list is probed at the middle, random access, binary search implemented this way inefficient.
- 7.(D). Input voltage should be greater than 12 V to allow for drop across R. Since Zener diode has to be reverse-biased, terminal A should, obviously, be positive.
- 8.(C). UHF range
- 9.(D). If each control field has k lines, then cell $\lceil \log_2 (k + 1) \rceil$ bits are needed. For 7, 3 lines exist. The closest power of 2 equal to or larger than $7 + 1$ is $2^3 = 8$. So 3 control bits are needed to describe those 7 lines Note: $7 + 1$ is needed since No activity is one more alternative besides selecting one of seven lines Likewise, $4 + 1$ requires 3 bits, $5 + 1$ requires 3 bits, $2 + 1$ requires 2 bits, $1 + 1$ requires 1 bit and $3 + 1$ requires 2 bits, so, the total number of bits needed is: $3 + 3 + 3 + 2 + 1 + 2 = 14$.
- 10.(A). Gamma rays
- 11.(D). Increasing the temperature will increase the thermal agitation in the molecule. This thermal agitation is the result of increased molecular vibrations. The kinked confirmation can be straightened with an applied stress. At higher temperature the molecules increase their resistance to the applied stress. Therefore, the elastic modulus increases with temperature.

12.(A). A-3, B-2, C-4, D-1

13.(B). Type A scope in Radar system displays target range alone.

14.(C). X-band, S - band, C-band, L-band

15.(D). Linear velocity of a satellite in a circular orbit is independent of its mass.

16.(C). The output $V_0(t) = i_1(t) R$

Also, $V_1(t) = (1/C) \int i_1(t) dt + i_1(t) R$

or $C dv_1(t)/dt = i_1(t) + RC di_1(t)/dt$

or $i_1(t) = C dv_1(t)/dt$

if $RC < T$ or $i_1(t)$ or $V_1(t)$

$\therefore V_0(t) = RC dv_1(t)/dt$

Similarly, we can see that L-R circuit, under the condition $L/R > T$, acts as an integrator.

Thus for the circuit shown and under the conditions stated, the output would be

$$v_0(t) = \frac{RC dv_1(t)}{dt} + \frac{1}{L/R} \int v_2(t) dt + \frac{R}{R_3} v_3(t)$$

17.(C). Transmission of power to a load over a transmission line achieves optimum value when SWR becomes 1: 1.

18.(D). Resonant pulse inverters are used when the variation of the dc output voltage is not wide.

The inverter frequency is very high and the output voltage is almost sinusoidal. Due to resonant oscillation, the transformer core is always reset and there is no dc saturation problem.

19.(B).

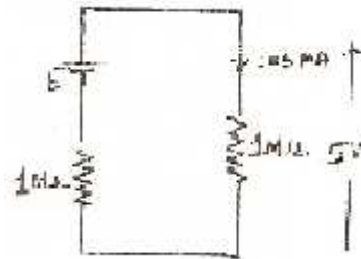

Voltmeter resistance = 100×10

= 1000 k - ohm

= 1 M - ohm

Photovoltaic cell internal resistance

= 1 M - ohm The voltmeter reads 5 V.

Therefore, the internal voltage is 10 V.

20.(B). A-3, B-1, C-2, D-4

21.(D). There are 64 words in a block. So, the 4K cache has $(4 \times 1024) / 64 = 64$ blocks. Since 1 set has 4 blocks, there are 16 sets. 16 sets need a 4 bit representation. In a set there are 4 blocks. So, the block field needs 2 bits. Each block has 64 words. So, the word field has 6 bits.

22.(C). It should be remembered that for charging a battery, its positive terminal must be connected to the positive end of the dc supply.

23.(A). The overall modulation index = $\sqrt{(0.3)^2 + (0.4)^2} = 0.5$

24.(D). Memory mopped I / O.

1. I / O have 16 bit addresses.
2. Devices are accessed like registers
3. Mass devices = $2^{16} = 256 \times 256$
4. Arithmetic / Logic operations can be done.

25.(C). Low grade fuels have low calorific value

26.(B). The definition of atomic packing factor is the ratio:

$$\frac{\text{Volume of atoms per unit cell}}{\text{Volume of the unit cell}}$$

Since aluminum has 6% greater atomic packing factor, then it has a lesser inverse ratio of volume of unit cell to volume of atoms per unit cell.

27.(A). Property of matched junctions

28.(D). Radar becons are used for target identification, navigation and causing for significant extensions of the maximum range.

29.(D). None of the statements is correct because a microwave cavity does not resonate at a number of frequencies.

30.(B). Satellite repeater serves to repeat the satellite signals received.

31.(A). As explained in Q. 20, C-R circuit acts as a differentiator under appropriate conditions. We can associate output waveforms with the input waveform by checking whether as particular output waveform with the input waveform by checking whether as particular output waveform is obtained by taking the derivative of input waveform being considered. Wherever there is a jump discontinuity in the function, the derivative function at that has impulse function, we arrive at answer (a).

32.(C). The relationship between SWR and K_r of a transmission line is

$$\text{SWR} = \frac{1 + K_r}{1 - K_r}$$

33.(D). To meet the torque speed duty cycle of a drive, the voltage, current and frequency control are normally used.

34.(B). If it is a symmetrical square wave of value 1V, or any other symmetrical wave having mean value of 1V, then the rectifier type instrument will read 1.11V as it is calibrated to read 1.1 times the mean value. Probable answer is (b).

35.(D). The step response is $-0.5 (1 + e^{-2t}) u(t)$. The impulse response is the derivative of above expression,

$$h(t) r\delta(t) = 0.5 \delta(t) + e^{-2t} u(t)$$

\therefore The system function for 1st control system is

$$H_1(s) = -0.5 + \frac{1}{s+2} = \frac{-0.58}{(s+2)}$$

$$H_2(s) = \alpha e^{-t} = \frac{1}{s+1}$$

$$\begin{aligned} \therefore H(s) &= H_1(s) H_2(s) \\ &= [-0.5 + 1/(s+2)] 1/(s+1) \\ &= \frac{-0.5s}{(s+2)(s+1)} \end{aligned}$$

36.(C). $Y = (G + F + H)$

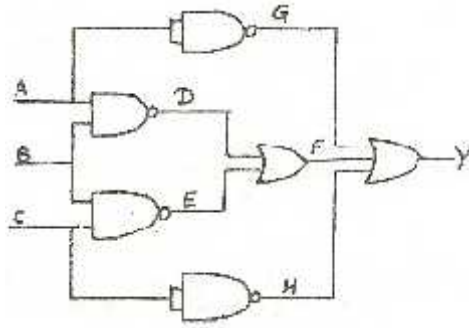

$$\begin{aligned} &= (\overline{AA}) + (D + E) + (\overline{CC}) \\ &= (\overline{A} + \overline{A}) + (\overline{AB} + \overline{BC}) + (\overline{C} + \overline{C}) \\ &= \overline{A} + \overline{AB} + \overline{BC} + \overline{C}. \end{aligned}$$

37.(A). The formula is

$$C_{\min} = \frac{0.24}{rR_L} F$$

Where r is ripple factor in percent.

$$\therefore C_{\min} = \frac{0.24}{2 \times 10000} \quad F = 12 \sim F$$

38.(D). Image frequency = $1200 + 2 \times 450 = 2100$ KHz.

39.(B). After instruction:

2000 SP \rightarrow 1000 PC \rightarrow 2003

2003 SP \rightarrow OFF DE (SP decrement by 2)

2004 SP \rightarrow OFFC (SP decrement by 2)

2005 PC \rightarrow 2050

SP has OFFC, PC has 2050.

40.(D). The different components of ink would move along the pores of the paper at different rates, thus making separation possible. All the other choices are inappropriate.

41.(B). The nature of atomic bond found in diamond is covalent.

42.(C). Preventing higher order modes from propagating

43.(D). The Doppler Effect is used in Pulsed Radar and MTI

- 44.(C). Two dissimilar antennas having their maximum directivities equal may not necessarily have their maximum power gains equal.
- 45.(C). A satellite earth station has both transmitting as well as receiving equipment.
- 46.B. A relation is reflexive if every element of the set is related to itself. This is true; R includes (x, x) , (y, y) , and (z, z) .
- A relation is irreflexive, if no element is related to itself. This is clearly untrue for R.
- A relation is symmetric if, for any two distinct elements of the set, say, x and y, then if x is related to y, y is related to x.
- Now, since R contains (x, y) and also (y, x) , it may appear to be symmetric at first sight. However, R also contains (y, z) but (z, y) is absent. We conclude that R not symmetric.
- A relation is ant symmetric if for any two distinct elements x and y, if x is related to y, y is not related to x. We observe (x, y) and (y, x) present in R, so R is not ant symmetric.
- 47.A. 10 ms.
- 48.D. Optical communication, Radio communication, Telephone and Microwave communication.
- 49.C. $2^{12} = 4096 \Rightarrow 4 \text{ K}$
- 50.C. Glass rod.