

# **APPRENTICESHIP TRAINING**

## **TRADE ENTRANCE EXAM Study Guide**

**Government  
of Alberta ■**

2003, Her Majesty the Queen in right of the Province of Alberta, as represented by the Minister of Learning, 10th floor, Commerce Place, Edmonton, Alberta, Canada, T5J 4L5. All rights reserved. No part of this material may be reproduced in any form or by any means, without the prior written consent of the Minister of Learning.

Care has been taken to acknowledge all sources and references in these materials. If there are any inadvertent omissions, please contact Alberta Learning, 10th floor, Commerce Place, Edmonton, Alberta, Canada, T5J 4L5.

## Table of Contents

What is a trade entrance exam? .....	3
What's the exam like?.....	3
How can this study guide help me prepare? .....	4
What is in this study guide? .....	4
How do I use this study guide?.....	5
Examination Instructions .....	7
Mathematical Formulas .....	8
Trade Entrance Exam Study Guide.....	9
Mathematics .....	9
English & Reading Comprehension.....	17
Science .....	20
Trade Entrance Exam Answer Key.....	33
Alberta Apprenticeship and Industry Training Client Services .....	34

## What is a trade entrance exam?

If you are taking an apprenticeship program in Alberta, you must meet the educational requirements for your trade before you can start your technical training.

If you cannot prove you meet the educational requirements for your trade, you can write a trade entrance exam. Passing this exam will prove that you have the basic educational requirements for technical training in your trade. If you pass a trade entrance exam with a mark of 70% or higher, you are eligible to attend technical training.

Trade entrance exams are given by Alberta Apprenticeship and Industry Training and can be written at any Alberta Apprenticeship and Industry Training Office (see page 34 & 35 for locations).

## What's the exam like?

There are five different trade entrance exams one for each of the five different clusters of trades. Each cluster includes trades and occupations that have similar skill and knowledge requirements.

For example, the Construction Craft Labourer occupation and the Hairstylist trade are both in Cluster 1. These two careers are very different, but require a similar knowledge of English, mathematics and science in their first year of technical training. (see page 6 for a list of the trades and occupations in each cluster).

The trade entrance exam for each cluster includes questions that test for educational requirements for the trades and occupations in that cluster. The exams are made up of 100 multiple-choice questions that cover the areas of English/reading comprehension, mathematics and science.

Depending on which cluster the trade is in, there will be a set number of questions from each of these areas as shown in the chart below.

Cluster	English/Reading Comprehension	Mathematics	Science	Total Questions
1	10	30	60	100
2	22	50	28	100
3	29	36	35	100
4	22	33	45	100
5	17	48	35	100
Average	20	40	40	

You will have 3 hours to complete your exam. A mark of 70% or greater is required to pass the trade entrance exam.

## How can this study guide help me prepare?

Many people who write the trade entrance exam have been out of school for several years. This guide will give you an idea of the kind of questions that will be on the exam so you can see what areas you may need to brush up in ahead of time. If you find you need some help, the following organizations may offer upgrading courses or pre-employment programs that can help you prepare to write the entrance exam.

- Bow Valley College
- Fairview College
- Grande Prairie Regional College
- Grant MacEwan College
- Keyano College
- Lakeland College
- Lethbridge Community College
- Medicine Hat College
- Mount Royal College
- Norquest College
- Northern Lakes College
- Olds College
- Red Deer College
- Northern Alberta Institute of Technology (NAIT)
- Southern Alberta Institute of Technology (SAIT)

Your local school or school board may also be able to provide help in preparing for the exam.

This guide can also help you refresh and improve your study and exam writing skills. Use it to practice before your exam. Contact your local Apprenticeship and Industry Training office for further information.

## What is in this study guide?

This trade entrance exam study guide includes:

- sample questions like those on any of the five trade entrance exams
- an answer key for the questions included in the study guide
- study and exam writing tips
- copies of the formula and metric conversion charts used with the trade entrance exams
- a sample diagram booklet that includes some typical diagrams used for the trade entrance exams
- a list of the trades and occupations included in each cluster

## How do I use this study guide?

This study guide can help you become more comfortable with writing exams and with the kinds of questions included in each of the five trade entrance exams. There are 70 sample questions included in the guide. Each one covers knowledge needed in at least one of the five clusters. The clusters a question covers are noted below it in the guide.

Here's how you can use these questions to get ready for your exam:

1. Read each question in the study guide carefully to get an idea of the kind of questions, the level of difficulty and the knowledge you will be tested on. This will help you focus your studying in the areas that need the most work.
2. Exam writing takes planning to ensure you have enough time to answer all the questions on the exam to the best of your ability and within the time allowed. These sample questions can help you determine how much time it will take you to complete individual questions when writing the exam. Practise reading over and recognizing the questions that will take more or less time to answer.
3. Look over the diagrams and formulas that are used in the questions. Make sure you can interpret what is shown in the diagrams. Often, the questions that relate to diagrams will require some interpretation and reasoning.
4. You may also want to study the formulas and conversion charts to make sure you know how to use them. You will be given the formula sheets and conversion charts to use during your exam.

## ENTRANCE EXAMINATIONS ARRAY

### **ENTRANCE 1 77/01/03/20**

Construction Craft Labourer  
Hairstylist

### **ENTRANCE 2 77/02/01/10**

Baker  
Boilermaker  
Bricklayer  
Cabinetmaker  
Carpenter  
Concrete Finisher  
Cook  
Crane and Hoisting Equipment Operator  
Floorcovering Installer  
Glazier  
Insulator  
Ironworker  
Ironworker - MBSE  
Lather - Interior Systems Mechanic  
Locksmith  
Painter and Decorator  
Parts Technician  
Roofer  
Sheet Metal Worker  
Structural Steel and Plate Fitter  
Tiler  
Welder

### **ENTRANCE 3 77/03/01/10**

Agricultural Equipment Technician  
Auto Body Technician  
Automotive Service Technician  
Heavy Equipment Technician  
Landscape Gardener  
Motorcycle Mechanic  
Outdoor Power Equipment Technician  
Recreation Vehicle Service Technician  
Sawfiler  
Transport Refrigeration Technician  
Water Well Driller

### **ENTRANCE 4 77/04/01/10**

Elevator Constructor  
Gas Utility Operator  
Gasfitter  
Machinist  
Millwright  
Plumber  
Sprinkler Systems Installer  
Steamfitter – Pipefitter

### **ENTRANCE 5 77/05/01/10**

Appliance Service Technician  
Communication Technician  
Electrical Motor Systems Technician  
Electrician  
Electronic Technician  
Instrument Technician  
Power Lineman  
Power System Electrician  
Refrigeration and Air Conditioning Mechanic

NOTE: A pass mark earned on Entrance Exam 5 = deemed to have also passed Entrance Exams 4, 3, 2 and 1.

A pass mark earned on Entrance Exam 4 = deemed to have also passed Entrance Exams 3, 2 and 1.

A pass mark earned on Entrance Exam 3 = deemed to have also passed Entrance Exam 1 (due to the significant differential in math/science content, a pass mark on Entrance Exam 3 does NOT allow a pass mark on Entrance Exam 2).

A pass mark earned on Entrance Exam 2 = deemed to have also passed Entrance Exam 1.

Alberta entrance exams are also used for entrance into trades in the Yukon Territory. Candidates who successfully complete an Alberta entrance exam may enter an apprenticeship in Alberta or the Yukon Territory.

## Examination Instructions

THESE INSTRUCTIONS ARE INCLUDED IN THE EXAM BOOKLET.

You should have in front of you:

- (1) a test booklet;
- (2) a green calculation sheet
- (3) an answer sheet (be sure you have filled in the required information); and
- (4) an eraser and an HB pencil.

IF YOU DO NOT HAVE ALL OF THESE MATERIALS,  
PLEASE INFORM THE TEST ADMINISTRATOR.

### Permissible Materials for Examinations

Candidates may bring a cordless pocket sized non-programmable mini calculator into the examination room for their personal use.

This examination is composed of 100 multiple-choice questions, each with four answer choices; ALL examinees are to complete all 100 questions.

You may use any of the formulas provided on page 5 of this examination.

Read each question carefully and choose the ONE best answer. Record your answer on the answer sheet in the space that corresponds to the question number. Completely fill in the space having the same letter as the answer you have chosen. Use only an HB pencil. Be sure to erase cleanly any answer you wish to change.

Sample Question: 1. What is the capital of Canada?

- A. Vancouver
- B. Yellowknife
- C. Ottawa
- D. St. John's

The correct answer to this question is C. You would indicate that on the answer sheet as follows:

1.            A    B    C    D

<input type="radio"/>	<input type="radio"/>	<input checked="" type="radio"/>	<input type="radio"/>
-----------------------	-----------------------	----------------------------------	-----------------------

Try to answer all questions. In general, if you have some knowledge about a question, it is better to try to answer it. You will **NOT** be penalized for guessing.

In the test questions, he is used as a generic term to denote any person, male or female.

You will have three hours to complete the test. Once the test has begun, you should continue from page to page, in sequence, throughout the test booklet.

If you have any questions, please ask them now before beginning the test.

**DO NOT GO ON UNTIL YOU ARE TOLD TO DO SO.**



## Mathematical Formulas (These formulas are included in the exam booklet)

You may make use of the following formulas when answering certain questions in this examination.

$$\pi = 3.14$$

$$\text{Circumference of a circle} = \pi D$$

$$\text{Area of a rectangle} = \text{Length} \times \text{Width}$$

$$\text{Area of a circle} = \pi r^2$$

$$\text{Area of a triangle} = \frac{\text{Altitude} \times \text{base}}{2}$$

$$\text{Volume of a cylinder} = \pi r^2 h$$

$$\text{Volume of a cube} = \text{Length} \times \text{Width} \times \text{Height}$$

### METRIC CONVERSIONS

#### Distance

Imperial		Metric		Metric		Imperial
1 inch	=	2.540	centimeters	1 centimeter	=	0.3937 inch
1 foot	=	0.3048	meter	1 meter	=	3.281 feet
1 yard	=	0.9144	meter	1 meter	=	1.094 yards
1 rod	=	5.029	meters	1 meter	=	0.20 rods
1 mile	=	1.609	kilometers	1 kilometer	=	0.6214 mile

#### Capacity

Imperial				U.S.		
1 pint	=	0.568	liters	1 pint (U.S.)	=	0.473 liter
1 gallon	=	4.546	liters	1 quart (U.S.)	=	0.946 liter
1 bushel	=	36.369	liters	1 gallon (U.S.)	=	3.785 liters
1 fluid oz.	=	28.41	ml	1 barrel oil	=	158.99 liters
1 quart	=	1.137	liters	1 cup-8 fl. ounces	=	227.00 ml
Metric						
1 liter	=	1.76	pints	1 tablespoon	=	14.21 ml
1 liter	=	0.220	gallon	1 teaspoon	=	4.74 ml
1 liter	=	.88	quart			

#### Weight

Imperial				Metric		
1 ounce (troy)	=	31.103	grams	1 gram	=	0.032 ounce (troy)
1 ounce (avoir)	=	28.350	grams	1 gram	=	0.035 ounce (avoir)
1 pound (troy)	=	373.242	grams	1 kilogram	=	2.679 pounds (troy)
1 pound (avoir)	=	453.592	grams	1 kilogram	=	2.205 pounds (avoir)
1 ton (short)	=	1	tonne		=	1.102 ton (short)
(2000 lb)	=	0.907	tonne*	1 tonne	=	1000 kilograms

## Trade Entrance Exam Study Guide

Use this study guide to get a sense for how much time is required to answer questions of the type included in the guide. An important skill in writing multiple choice exams is ensuring you have enough time to get through all questions on the exam. The time allotted to write the Entrance Exam is 3 hours and each exam includes 100 questions. Therefore, you have an average of approximately 1½ minutes per question to complete the exam within the time allowed. Note the cluster that includes the trade you have chosen to enter (page 6) and pay special attention to the questions that are identified for that cluster.

**NOTE:** The answer key for all the following questions in this study guide can be found at the end of the study guide (page 33)

### SECTION ONE: MATHEMATICS

**Studying for the mathematics section of the trade entrance exam.**

Each Entrance Exam includes a section for mathematics questions. The questions are designed to challenge the exam writer's ability to perform basic calculations, manipulate basic equations, and use formulas. The types of questions asked and the difficulty will vary with the exam for each cluster.

1.  $11 \times 6 + 7 \times 4 =$

- A. 94
- B. 101
- C. 292
- D. 572

*This question is applicable to Cluster 2, Cluster 3, Cluster 4, Cluster 5.*

2. Which is the smallest number?

- A. 0.01001
- B. 0.00998
- C. 0.00385
- D. 0.00297

*This question is applicable to Cluster 2, Cluster 3, Cluster 5.*

3.  $-23.7 + 88 - 56 + 407.9 =$

- A. 202.9
- B. 287.6
- C. 416.2
- D. 463.6

*This question is applicable to Cluster 2, Cluster 4, Cluster 5.*

**Trade Entrance Exam Study Guide**

4.  $7 \text{ ft. } 4 \text{ in.} + 10 \text{ ft. } 9 \text{ in.} =$

- A. 183 in.
- B. 197 in.
- C. 203 in.
- D. 217 in.

*This question is applicable to Cluster 2, Cluster 3, Cluster 4, Cluster 5.*

5. A mother wants to divide \$680.00 among her children according to the ratio 2:4:6. The shares would be

- A. \$113.33, \$226.67, \$340.00
- B. \$118.33, \$220.67, \$340.00
- C. \$120.00, \$220.00, \$340.00
- D. \$136.00, \$204.00, \$340.00

*This question is applicable to Cluster 2, Cluster 3, Cluster 4, Cluster 5.*

6. If 5 liters of paint cover 20 square meters, how many liters are required to cover 400 square meters?

- A. 40 liters
- B. 52 liters
- C. 80 liters
- D. 100 liters

*This question is applicable to Cluster 2, Cluster 3, Cluster 4, Cluster 5.*

7.  $\frac{3}{8} + \frac{3}{4} =$

- A.  $\frac{9}{32}$
- B.  $\frac{1}{2}$
- C.  $1\frac{1}{8}$
- D.  $1\frac{1}{4}$

*This question is applicable to Cluster 2, Cluster 3, Cluster 4, Cluster 5.*

**Trade Entrance Exam Study Guide**

8. A piece of sheet metal is  $28\frac{1}{2}$  inches wide. A piece  $13\frac{5}{16}$  inches is cut off. How wide will the remaining piece of sheet metal be?
- A.  $14\frac{1}{4}$  inches.
  - B.  $15\frac{3}{16}$  inches.
  - C.  $15\frac{13}{16}$  inches.
  - D.  $16\frac{1}{4}$  inches.

*This question is applicable to Cluster 2, Cluster 3, Cluster 5.*

9. When 2.49 is multiplied by 0.17, the result rounded to 2 decimal places is
- A. 0.04
  - B. 0.42
  - C. 4.23
  - D. 42.33

*This question is applicable to Cluster 1.*

10. Subtract 64.85 from 209.11
- A. 44.260
  - B. 144.260
  - C. 202.625
  - D. 273.960

*This question is applicable to Cluster 1, Cluster 2, Cluster 3, Cluster 4, Cluster 5.*

11. Express  $\frac{3}{8}$  as a decimal number.
- A. 0.240
  - B. 0.267
  - C. 0.375
  - D. 2.667

*This question is applicable to Cluster 2, Cluster 3, Cluster 4.*

**Trade Entrance Exam Study Guide**

12. What is  $8^2$ ?

- A. 10
- B. 16
- C. 64
- D. 82

*This question is applicable to Cluster 1.*

13. The area of a circle 200 mm in diameter is approximately how many times greater than the area of a circle 40 mm in diameter?

- A. 5
- B. 10
- C. 20
- D. 25

*This question is applicable to Cluster 2, Cluster 3, Cluster 4.*

14. The area of a circle with a diameter of 240 mm is

- A.  $75.36 \text{ cm}^2$
- B.  $150.72 \text{ cm}^2$
- C.  $452.16 \text{ cm}^2$
- D.  $1,808.64 \text{ cm}^2$

*This question is applicable to Cluster 1, Cluster 2.*

15. A corner grocery store sold 14 boxes of oranges. Each box contained 5 pounds of oranges. If the profit per box was \$1.85, what was the total profit?

- A. \$129.50
- B. \$37.84
- C. \$25.90
- D. \$12.95

*This question is applicable to Cluster 2, Cluster 3, Cluster 4, Cluster 5.*

**Trade Entrance Exam Study Guide**

16. Barry has a job painting new houses. One week he worked the following hours:

Monday	7.5 hours
Tuesday	10.0 hours
Wednesday	6.0 hours
Thursday	12.0 hours
Friday	14.5 hours
Saturday	10.0 hours

What was the average number of hours Barry worked per day?

- A. 9.5
- B. 10.0
- C. 10.5
- D. 11.0

*This question is applicable to Cluster 2, Cluster 3, Cluster 4, Cluster 5.*

17. How many cubic meters of cement are required to cover a walkway 7 m long, 0.95 m wide, and 10 cm deep?

- A.  $66.500 \text{ m}^3$
- B.  $6.650 \text{ m}^3$
- C.  $0.737 \text{ m}^3$
- D.  $0.665 \text{ m}^3$

*This question is applicable to Cluster 2, Cluster 3, Cluster 4, Cluster 5.*

18. A rectangular school yard 280 meters by 245 meters is to be fenced. How many meters of fencing will be required to fence it completely?

- A. 525 m
- B. 705 m
- C. 770 m
- D. 1050 m

*This question is applicable to Cluster 2, Cluster 3, Cluster 4.*

19. A parking lot charges \$1.50 for the first hour of parking and 55 cents for each additional half hour. How much would it cost to park a car from 12:45 p.m. to 6:15 p.m.?

- A. \$4.65
- B. \$6.05
- C. \$6.45
- D. \$11.28

*This question is applicable to Cluster 2, Cluster 3, Cluster 4, Cluster 5.*

**Trade Entrance Exam Study Guide**

20. If a contractor pays an average wage of \$20.00 per hour and wants to make a 15% mark-up on the cost of labour, what will the contractor charge as an average labour cost on contracts?
- A. \$20.30
  - B. \$21.50
  - C. \$23.00
  - D. \$26.00

*This question is applicable to Cluster 3, Cluster 4, Cluster 5.*

21. What is the circumference of a circle with a diameter of 50 mm?
- A. 78.5 mm
  - B. 157.0 mm
  - C. 78.5 cm
  - D. 157.0 cm

*This question is applicable to Cluster 3, Cluster 4, Cluster 5.*

22.  $\frac{5}{8}$  divided by  $\frac{1}{2}$  equals
- A.  $1\frac{1}{4}$
  - B.  $\frac{3}{8}$
  - C.  $\frac{1}{4}$
  - D.  $\frac{3}{16}$

*This question is applicable to Cluster 1.*

23. If  $3(y + 3y) = 12$ , solve for y.
- A. 2.0
  - B. 1.5
  - C. 1.0
  - D. 0.0

*This question is applicable to Cluster 2, Cluster 3, Cluster 5.*

**Trade Entrance Exam Study Guide**

24. If  $4(2x + 3x) = 30$ , solve for  $x$ .
- A. 1.50
  - B. 1.75
  - C. 2.00
  - D. 2.50

*This question is applicable to Cluster 2, Cluster 3, Cluster 5.*

25. What is the simple interest of \$1500.00 for 4 months at  $6\frac{3}{4}\%$  annual interest?
- A. \$222.22
  - B. \$101.25
  - C. \$50.63
  - D. \$33.75

*This question is applicable to Cluster 1.*

26. Which polynomial expression would have a value of -2 when  $x = -2$  ?
- A.  $2x^2 + 2x - 2$
  - B.  $3x^2 - 4x + 1$
  - C.  $x^2 + 3x + 2$
  - D.  $-x^2 - 4x - 6$

*This question is applicable to Cluster 3, Cluster 5.*

27. Five rental cars require four new tires each. The price for one new tire is \$84.00. What would be the total cost including 7% tax for new tires for all five cars?
- A. \$2856.00
  - B. \$1797.60
  - C. \$1680.00
  - D. \$1570.09

*This question is applicable to Cluster 2, Cluster 4, Cluster 5.*



**Trade Entrance Exam Study Guide**

28. What is the radius of a circle with a diameter of 240 mm?
- A. 76.43 mm
  - B. 480.00 mm
  - C. 12.00 mm
  - D. 120.00 mm

*This question is applicable to Cluster 2, Cluster 3, Cluster 4, Cluster 5.*

29. A journeyperson earns \$23.45 per hour. A new apprentice earns 60% of the journeyperson rate and has 27% deductions. What would the apprentice's net weekly earnings be for a 40 hour week?
- A. \$273.90
  - B. \$379.89
  - C. \$410.84
  - D. \$562.80

*This question is applicable to Cluster 2, Cluster 3, Cluster 4, Cluster 5.*

30. Refer to Diagram 011. If  $x = 12.5$  cm, what is the area of the rectangle?
- A. 22.73 cm<sup>2</sup>
  - B. 30.25 cm<sup>2</sup>
  - C. 68.75 cm<sup>2</sup>
  - D. 87.50 cm<sup>2</sup>

*This question is applicable to Cluster 1, Cluster 2, Cluster 3.*

## Trade Entrance Exam Study Guide

NOTE: The answer key for all the following questions in this study guide can be found at the end of the study guide (page 33)

### SECTION TWO: ENGLISH & READING COMPREHENSION

#### *Studying for the English/Reading Comprehension section of the trade entrance exam.*

Clusters 1 through 5 include a section on reading comprehension. Cluster 1 also includes questions on English grammar. The English questions are designed to challenge the exam writer's ability to read, apply the rules of good grammar, and interpret written materials. The reading comprehension questions require the exam writer to read different types of information, recall details of the passage or material, and make inferences based on your interpretation of what you have just read.

### CAREFULLY READ THE FOLLOWING PARAGRAPHS AND ANSWER QUESTIONS 31 TO 34

#### Multiple Choice Exam Writing Strategies

##### **Watch Your Time**

For every exam it is important to calculate the amount of time you can spend on each section or question according to the number of marks it is worth. (Do the easy questions or sections first - this is helpful for calming nerves and establishing your concentration.) If your exam is all multiple choice, you may want to note where you should be after one hour and after two hours to ensure you aren't falling too far behind. It is important to work at a fairly quick pace; multiple choice exams are notorious for being long.

##### **Process the Question**

Careless mistakes are often made when students rush through the "stem" of the question, missing important information. Read the question carefully, noting key terms. Watch for negative or positive phrasing, or qualifying words like "always" or "never" which can drastically change the meaning of a statement. If you don't understand the stem, ask the exam supervisor for clarification. Before you look at the list of possible responses, try to recall the answer on your own. Then look at the alternatives to see which one best matches your answer. As you read through the possible responses, make a mental note of the ones you know are wrong. This will mean less reading time if you have to come back to the question later. If none of the selections seems close, re-read the question and try to determine what you missed. If you still can't get it, go on. Something in another question may trigger your memory so you can recall the answer later.

31. What is recommended as a method for establishing your concentration?
- A. Work at a fairly quick pace.
  - B. Look for qualifying words like "never" and "always".
  - C. Do the easy questions or sections first.
  - D. Read the question carefully, underlining key terms.

*This question is applicable to Cluster 1, Cluster 2, Cluster 3, Cluster 4, Cluster 5.*

**Trade Entrance Exam Study Guide**

32. What is a recommended strategy for ensuring you have enough time to complete the exam?
- A. Read each question quickly trying to get a sense of what is being asked for.
  - B. Estimate how far you should progress through the exam for each hour and mark on your notepaper.
  - C. Ask the exam supervisor to give you a reminder when each hour has passed.
  - D. As you read through the possible responses, mark off the ones you know are wrong.

*This question is applicable to Cluster 1, Cluster 2, Cluster 3, Cluster 4, Cluster 5.*

33. How should you work through a question that appears to have more than one correct answer?
- A. Ask for assistance from someone around you.
  - B. Guess since it's only one question.
  - C. If you are not sure always choose option "D".
  - D. Start by eliminating the answers you know are wrong.

*This question is applicable to Cluster 1, Cluster 2, Cluster 3, Cluster 4, Cluster 5.*

34. Why is it important to read through the "stem" carefully when answering the question?
- A. There may be words like "always" and "never" that drastically change the meaning of the statement.
  - B. It may be possible to answer the question on your own before looking at the list of possible responses.
  - C. You may be able to trigger something in your memory that will help with an earlier question you were not able to answer.
  - D. You will get a better sense of how long it is going to take to write the exam and be able to judge more accurately if you still have enough time.

*This question is applicable to Cluster 1, Cluster 2, Cluster 3, Cluster 4, Cluster 5.*

35. Which sentence uses correct grammar?
- A. Our printers don't work too good.
  - B. Brewing coffee results in bitterness using more water.
  - C. Apprenticeship involves a combination of work experience and formal training.
  - D. Tests used to measure your knowledge take long to write.

*This question is applicable to Cluster 1.*

**Trade Entrance Exam Study Guide**

36. Which of the following groups of words is not a complete thought?
- A. Building a large house takes time.
  - B. When you have a chance to travel to a tropical location.
  - C. Given enough information, you should be able to answer the question.
  - D. Take a sweater along, it may be chilly.

*This question is applicable to Cluster 1.*

37. Choose the correct spelling.
- A. Adressed
  - B. Adresed
  - C. Addressed
  - D. Addressed

*This question is applicable to Cluster 1.*

**Trade Entrance Exam Study Guide**

NOTE: The answer key for all the following questions in this study guide can be found at the end of the study guide (page 33)

**SECTION THREE: SCIENCE**

***Studying for the Science section of the trade entrance exam.***

*Each Entrance Exam includes a section for Science questions. The questions are designed to challenge the exam writer's ability to recall basic information, manipulate basic equations, and interpret basic scientific relationships. The types of questions asked and the difficulty will vary with the exam for each cluster.*

38. What does 6.4 liters of water equal in imperial gallons?

- A. 1.408 gal.
- B. 3.635 gal.
- C. 5.628 gal.
- D. 5.632 gal.

*This question is applicable to Cluster 2, Cluster 4, Cluster 5.*

39. Convert 11.4 km to miles and express to two decimal places.

- A. 5.70 mi.
- B. 7.08 mi.
- C. 9.79 mi.
- D. 18.34 mi.

*This question is applicable to Cluster 1, Cluster 2, Cluster 3, Cluster 4, Cluster 5.*

40. How many tablespoons are there in 49.74 ml?

- A. 3.50 tbsp.
- B. 10.49 tbsp.
- C. 35.00 tbsp.
- D. 706.81 tbsp.

*This question is applicable to Cluster 1, Cluster 2, Cluster 3, Cluster 4, Cluster 5.*

**Trade Entrance Exam Study Guide**

41. When a gas is heated it

- A. expands.
- B. contracts.
- C. condenses.
- D. solidifies.

*This question is applicable to Cluster 1, Cluster 2, Cluster 3, Cluster 4, Cluster 5.*

42. Water at sea level heated to 100° Celsius would be

- A. expanding.
- B. just beginning to change to a solid.
- C. starting to boil.
- D. contracting.

*This question is applicable to Cluster 1, Cluster 2, Cluster 3, Cluster 4, Cluster 5.*

43. An object floats in water because the weight of water displaced is

- A. more than the object's weight.
- B. less than the object's weight.
- C. equal to the object's weight.
- D. not related to the object's weight.

*This question is applicable to Cluster 1, Cluster 2, Cluster 3, Cluster 4, Cluster 5.*

44. The cooling effect of alcohol on the skin is the result of

- A. sublimation of liquids.
- B. condensation of liquids.
- C. evaporation of liquids.
- D. contraction of liquids.

*This question is applicable to Cluster 1, Cluster 2, Cluster 3, Cluster 4, Cluster 5.*

45. Which of the following could be used to express density?

- A. Grams per centimeter.
- B. Grams per square centimeter.
- C. Grams per cubic centimeter.
- D. Grams per kilometer.

*This question is applicable to Cluster 1, Cluster 2, Cluster 3, Cluster 4, Cluster 5.*

**Trade Entrance Exam Study Guide**

46. The pressure gauge on a bottle containing a gas would show a lower reading if the gas in the bottle was
- A. to expand.
  - B. cooled.
  - C. heated.
  - D. a constant temperature.

*This question is applicable to Cluster 1, Cluster 2, Cluster 3, Cluster 4, Cluster 5.*

47. Which state is matter in if it has a definite shape and a definite volume?
- A. solid.
  - B. liquid.
  - C. gas.
  - D. fluid.

*This question is applicable to Cluster 1, Cluster 2, Cluster 3, Cluster 4, Cluster 5.*

48. The reason ice floats on water is because it
- A. is a solid.
  - B. contains more air.
  - C. has less heat energy than water.
  - D. is less dense than water.

*This question is applicable to Cluster 1, Cluster 2, Cluster 3, Cluster 4, Cluster 5.*

49. Compared to an elevation of 1,000 meters, the air pressure at sea level is generally
- A. lower.
  - B. higher.
  - C. the same.
  - D. lower in the summer.

*This question is applicable to Cluster 1, Cluster 2, Cluster 3, Cluster 4, Cluster 5.*

50. Assuming equal volumes, the expansion of solids is usually
- A. greater than liquids.
  - B. the same as liquids.
  - C. greater than gases
  - D. less than liquids.

*This question is applicable to Cluster 1, Cluster 2, Cluster 3, Cluster 4, Cluster 5.*

**Trade Entrance Exam Study Guide**

51. Which of the following is true?
- A. A liquid has no mass, shape, or volume.
  - B. A liquid will expand to fit the container it is in.
  - C. Liquids **can not** be easily compressed.
  - D. A liquid has mass but no shape or volume.

*This question is applicable to Cluster 1, Cluster 2, Cluster 3, Cluster 4, Cluster 5.*

52. The ability to do work is known as
- A. power.
  - B. energy.
  - C. force.
  - D. effort.

*This question is applicable to Cluster 1, Cluster 2, Cluster 3, Cluster 4, Cluster 5.*

53. A parallel circuit is one in which
- A. two batteries are included in the circuit.
  - B. current can flow through only one path.
  - C. current can flow through more than one path.
  - D. light bulbs must not be used.

*This question is applicable to Cluster 3, Cluster 4, Cluster 5.*

54. A series circuit includes several lamps. When the light bulb from one lamp is removed the other lights will
- A. stay lit.
  - B. stay lit and get brighter.
  - C. stay lit and get dimmer.
  - D. no longer be lit.

*This question is applicable to Cluster 3, Cluster 4, Cluster 5.*



**Trade Entrance Exam Study Guide**

55. Refer to diagram 003. To ensure safe climbing practice, the base of a straight ladder should be one meter out for every four meters of height to the point of support. If  $h = 8$  m, what is the value of  $d$ ?
- A. 2 m
  - B. 2.5 m
  - C. 3.2 m
  - D. 4 m

*This question is applicable to Cluster 1, Cluster 2, Cluster 3, Cluster 4, Cluster 5.*

56. When trying to move a 150 kg rock using a 3 meter pry bar you can make the task easier by placing a smaller rock under the pry bar
- A. 1.0 meter from the large rock.
  - B. 1.5 meters from the large rock.
  - C. 2.0 meters from the large rock.
  - D. 2.5 meters from the large rock.

*This question is applicable to Cluster 1, Cluster 2, Cluster 3, Cluster 4, Cluster 5.*

57. Given the relationship  $E(\text{voltage}) = I(\text{current}) \times R(\text{resistance})$ , what is the current in a circuit with  $E = 6$  volts and  $R = 15$  ohms?
- A. 0.04 amps
  - B. 0.40 amps
  - C. 4.00 amps
  - D. 40.00 amps

*This question is applicable to Cluster 3, Cluster 4, Cluster 5.*

58. A liter of water has a mass of
- A. 1 kg
  - B. 1 km
  - C. 1 ksec
  - D. 1 kW

*This question is applicable to Cluster 2, Cluster 3, Cluster 4.*

**Trade Entrance Exam Study Guide**

59. A fulcrum is used to support a

- A. wedge.
- B. ramp.
- C. drawer.
- D. lever.

*This question is applicable to Cluster 2, Cluster 3, Cluster 4, Cluster 5.*

60. Which of the following does not affect the amount of heat a body will store?

- A. Density.
- B. Altitude.
- C. Mass.
- D. Both (a) and (c).

*This question is applicable to Cluster 2, Cluster 3, Cluster 4, Cluster 5.*

61. If friction can cause heat to be released, letting a cord slide quickly through your hands will cause

- A. your hands to feel cool.
- B. your hands to become wet.
- C. your hands to feel warmer.
- D. your hands to feel stiff.

*This question is applicable to Cluster 1, Cluster 2, Cluster 3, Cluster 4, Cluster 5.*

62. What causes a coasting vehicle in motion to eventually come to a stop?

- A. Friction.
- B. Expansion.
- C. Contraction.
- D. Potential Energy.

*This question is applicable to Cluster 3, Cluster 4, Cluster 5.*

63. The chemical combination of two or more elements is known as a/an

- A. isotope.
- B. ion.
- C. compound.
- D. catalyst.

*This question is applicable to Cluster 1, Cluster 2, Cluster 3, Cluster 4, Cluster 5.*

**Trade Entrance Exam Study Guide**

64. The molecular composition of water is
- A. 2 hydrogen atoms + 2 oxygen atoms.
  - B. 1 hydrogen atom + 1 oxygen atom.
  - C. 2 hydrogen atoms + 1 oxygen atom.
  - D. 2 oxygen atoms + 1 Hydrogen atom.

*This question is applicable to Cluster 1, Cluster 2, Cluster 3, Cluster 4, Cluster 5.*

65. If a gas in a closed space is compressed, it will
- A. decrease in temperature.
  - B. increase in temperature.
  - C. solidify.
  - D. move more slowly.

*This question is applicable to Cluster 3, Cluster 4, Cluster 5.*

66. The reason inventors have not been able to invent a machine that is 100% efficient is because of
- A. gravity.
  - B. inertia.
  - C. technology.
  - D. friction.

*This question is applicable to Cluster 2, Cluster 3, Cluster 4, Cluster 5.*

67. How much work is done in 1 minute by a machine operating at 300 ft. lb./sec
- A. 300 ft lb
  - B. 1,800 ft lb
  - C. 18,000 ft lb
  - D. 180,000 ft lb

*This question is applicable to Cluster 2, Cluster 3, Cluster 4, Cluster 5.*

68. The volume of a cube which is 5 meters per side is
- A. 5 cubic meters.
  - B. 25 cubic meters.
  - C. 75 cubic meters.
  - D. 125 cubic meters.

*This question is applicable to Cluster 2, Cluster 3, Cluster 4, Cluster 5.*

**Trade Entrance Exam Study Guide**

69. Refer to Diagram 020. Four pumps are shown in the diagram. Arrows show the direction the piston is being moved. Choose the only pump that will pump water.
- A.
  - B.
  - C.
  - D.

*This question is applicable to Cluster 3, Cluster 4.*

70. Refer to Diagram 014. Which diagram shows what happens when heat is applied to a bi-metal strip consisting of stainless steel on the top and brass on the bottom? (Brass has the higher expansion rate.)
- A.
  - B.
  - C.
  - D.

*This question is applicable to Cluster 1.*

**TRADE ENTRANCE  
EXAM  
STUDY GUIDE**

**DIAGRAM BOOK**

**Entrance**

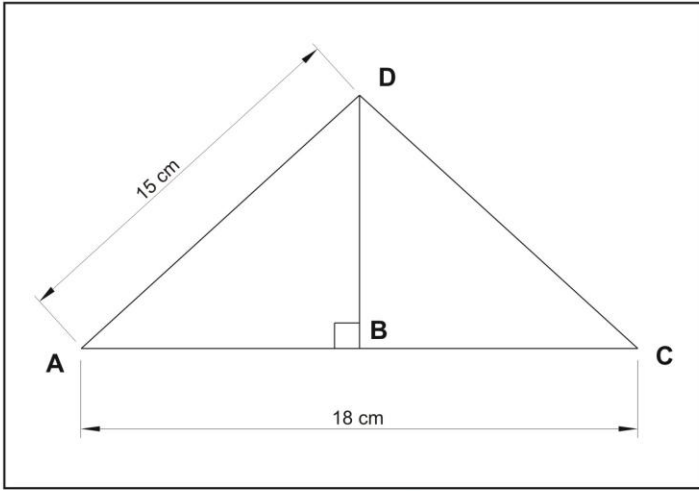


Diagram 001

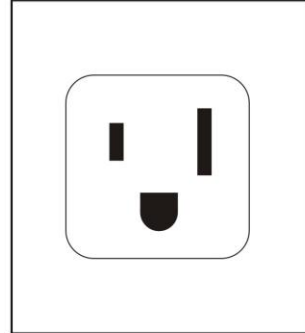


Diagram 002

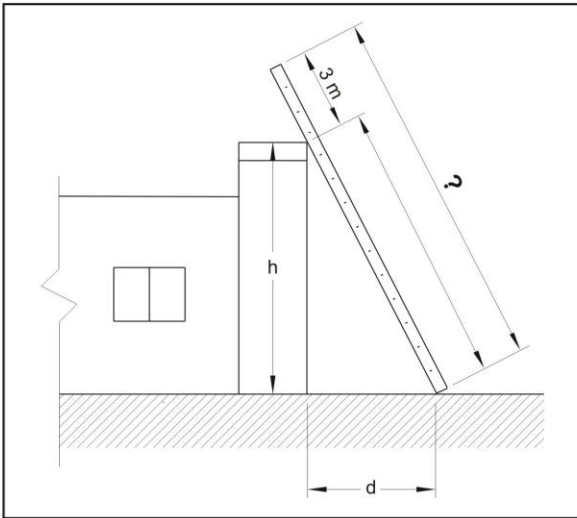


Diagram 003

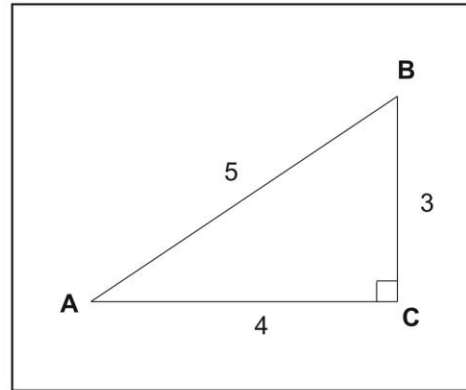


Diagram 004

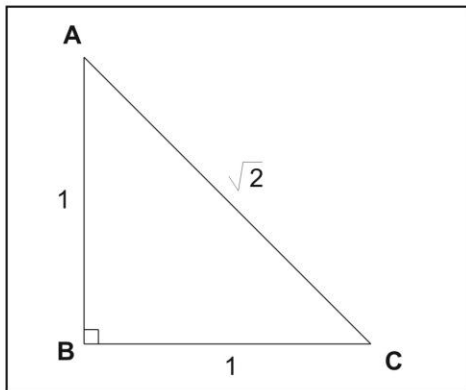


Diagram 005

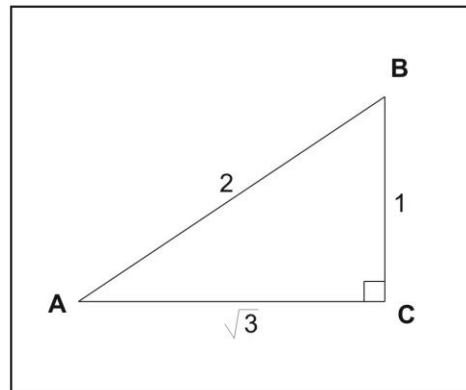
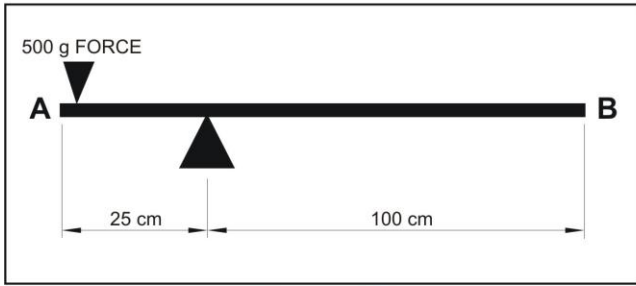
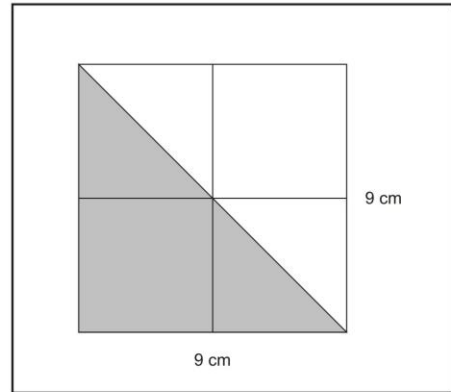


Diagram 006

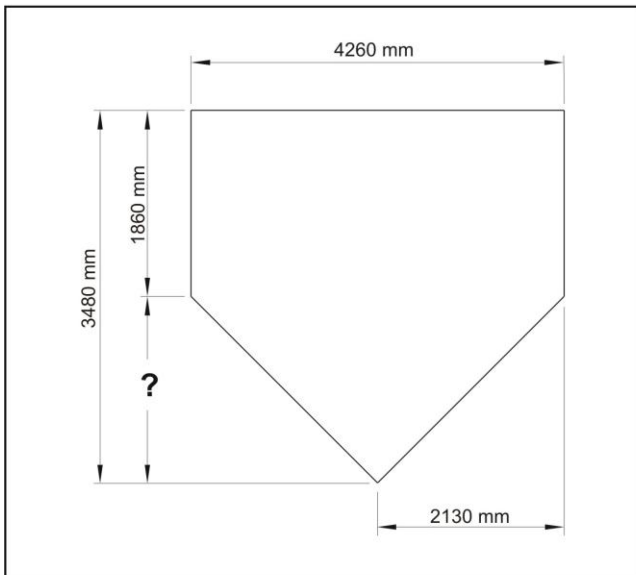
**Entrance**



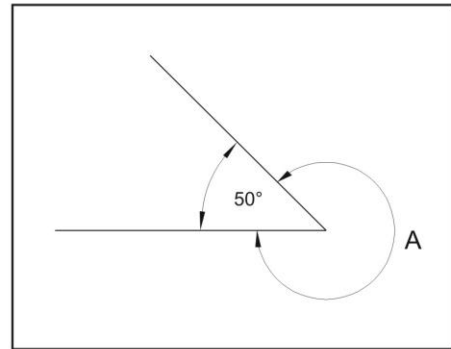
**Diagram 007**



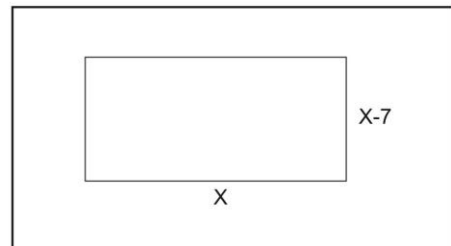
**Diagram 008**



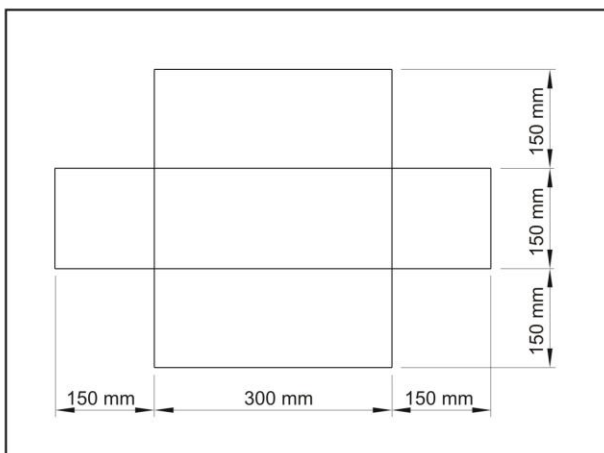
**Diagram 009**



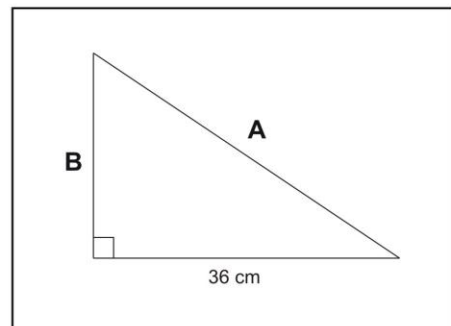
**Diagram 010**



**Diagram 011**

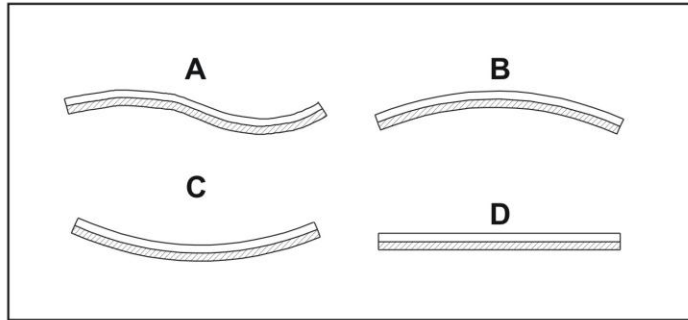


**Diagram 012**

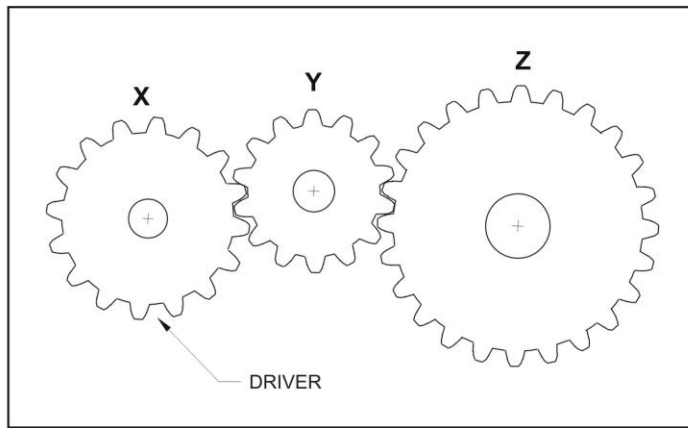


**Diagram 013**

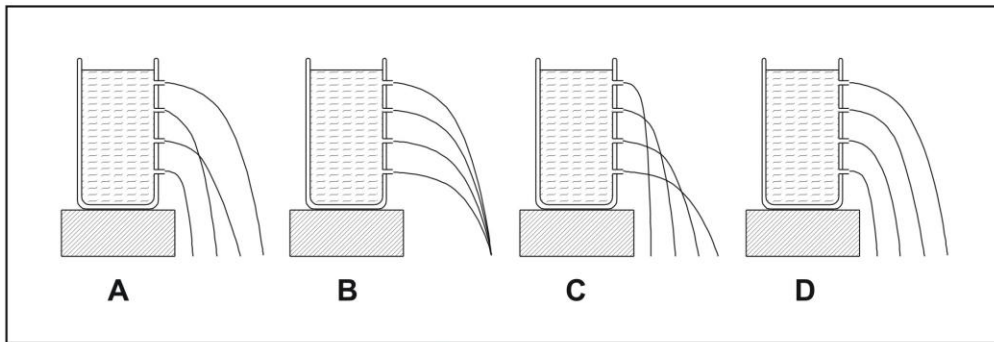
**Entrance**



**Diagram 014**



**Diagram 015**



**Diagram 016**

ANGLES	SINE	COSINE	TANGENT
0	0	1	0
30	0.5	0.866	0.577
45	0.707	0.707	1
60	0.866	0.5	1.732
90	1.0	0	---

**Diagram 017**



**Entrance**

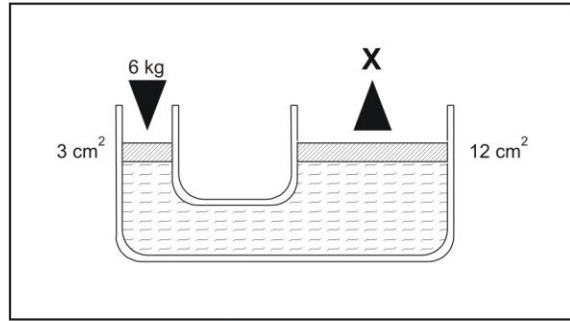


Diagram 018

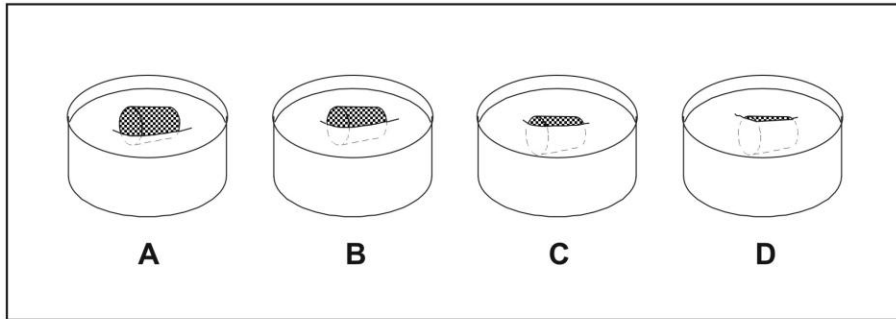


Diagram 019

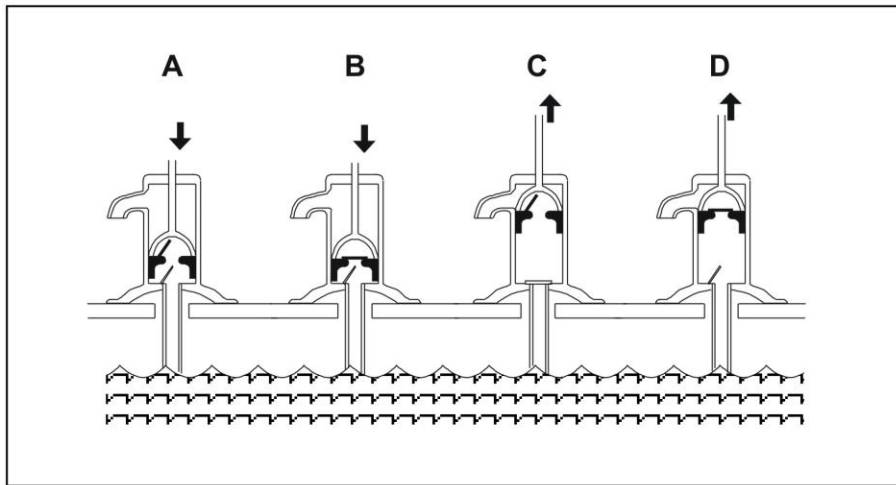


Diagram 020

## Trade Entrance Exam Answer Key

1.	A
2.	D
3.	C
4.	D
5.	A
6.	D
7.	C
8.	B
9.	B
10.	B
11.	C
12.	C
13.	D
14.	C
15.	C
16.	B
17.	D
18.	D
19.	C
20.	C
21.	B
22.	A
23.	C
24.	A
25.	D
26.	D
27.	B
28.	D
29.	C
30.	C
31.	C
32.	B
33.	D
34.	A
35.	C

36.	B
37.	D
38.	A
39.	B
40.	A
41.	A
42.	C
43.	C
44.	C
45.	C
46.	B
47.	A
48.	D
49.	B
50.	D
51.	C
52.	B
53.	C
54.	D
55.	A
56.	A
57.	B
58.	A
59.	D
60.	B
61.	C
62.	A
63.	C
64.	C
65.	B
66.	D
67.	C
68.	D
69.	D
70.	C

## **Alberta Apprenticeship and Industry Training Client Services**

### **Bonnyville**

New Park Place, Box 8115  
5201 - 44 Street  
T9N 2J4  
Main Phone: (780) 826-6142  
Fax: (780) 826-1904

### **Calgary**

Apprenticeship and Industry Training  
Suite 300, Willow Park Centre  
10325 Bonaventure Drive S.E.  
Calgary, Alberta  
T2J 7E4  
Main Phone: (403) 297-6457  
Fax: (403) 297-3799

### **Edmonton**

Apprenticeship and Industry Training  
7th Floor, Capital Health Centre, South Tower  
10030 - 107 Street, T5J 4X7  
Main Phone: (780) 427-8517  
Fax: (780) 422-3734

### **Fort McMurray**

Box 19, 7th Floor, Provincial Building  
9915 Franklin Avenue  
T9H 2K4  
Main Phone: (780) 743-7150  
Fax: (780) 743-7492

### **Grande Prairie**

Suite 100, Towne Centre Mall  
9845 - 99 Avenue  
T8V 0R3  
Main Phone: (780) 538-5240  
Fax: (780) 833-4253

### **Hinton**

568 Carmichael Lane  
T7V 1S8  
Main Phone: (780) 865-8293  
Fax: (780) 865-8376

**Lethbridge**

Room 280, Provincial Building  
200 - 5 Avenue S.  
T1J 4C7  
Main Phone: (403) 381-5380  
Fax: (403) 381-5795

**Medicine Hat**

104 Provincial Building  
346 - 3 Street SE  
T1A 0G7  
Main Phone: (403) 529-3580  
Fax: (403) 529-3564

**Peace River**

9715 - 100 Street Midwest Electric Bldg.  
Bag 900 - 28  
T8S 1T4  
Main Phone: (780) 624-6529  
Fax: (780) 624- 6476

**Red Deer**

3 rd Floor, First Red Deer Place  
4911 - 51 Street  
T4N 6V4  
Main Phone: (403) 340-5151  
Fax: (403) 340-5153

**Slave Lake**

3<sup>rd</sup> Floor, Lakeland Centre  
Box 787  
101 Main Street SE  
T0G 2A0  
Main Phone: (780) 849-7228  
Fax: (780) 849-7121

**Vermilion**

Box 26, 1st Floor, Provincial Building  
4701 - 52 Street  
T9X 1J9  
Main Phone: (780) 853-8150  
Fax: (780) 853-8203



Alberta Apprenticeship  
and Industry Training  
*Excellence through training and experience*

77SG03