



# **Sardar Vallabhbhai National Institute of Technology, Surat.**

## ***Training & Placement Section.***

*SVNIT offers Six Under Graduate (B.Tech), Seventeen Post Graduate (M.Tech) and Three M.Sc. Integrated courses (Chemistry, Physics & Mathematics) to the students. The Training & Placement Section (T&P) helps the student's community to get the proper placement in various public and private sector organizations by arranging the campus interviews.*

*Sardar Vallabhbhai National Institute of Technology (SVNIT) Surat is one of the NIT's operated under the guidance of MHRD-Govt. of India since its inception in 1961 (known as Regional Engineering College earlier). Admissions to various UG programs in SVNIT are processed on the basis of JEE (2013 onwards) results, whereas GATE score is the basis for admission in PG program.*

# Courses:

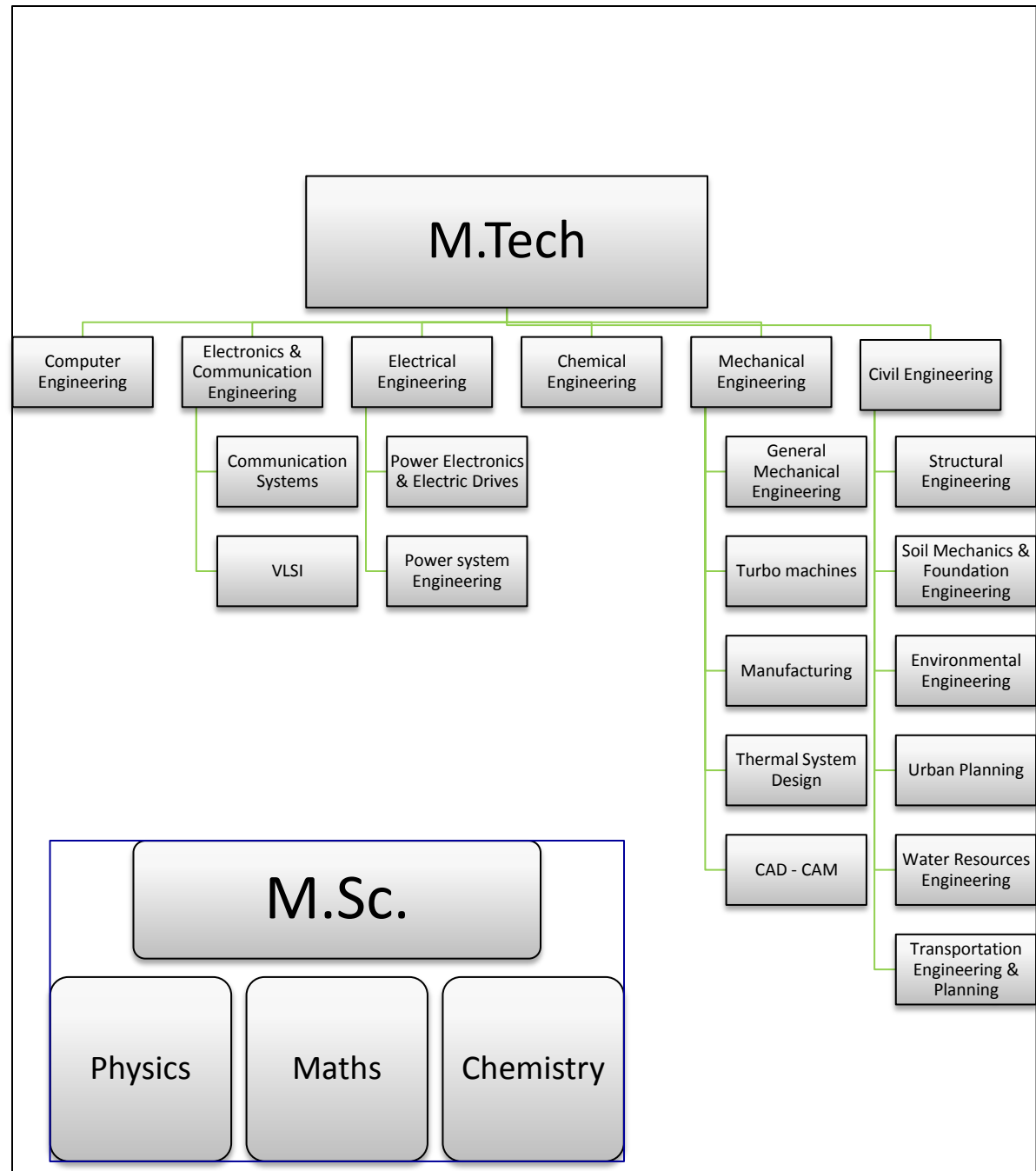
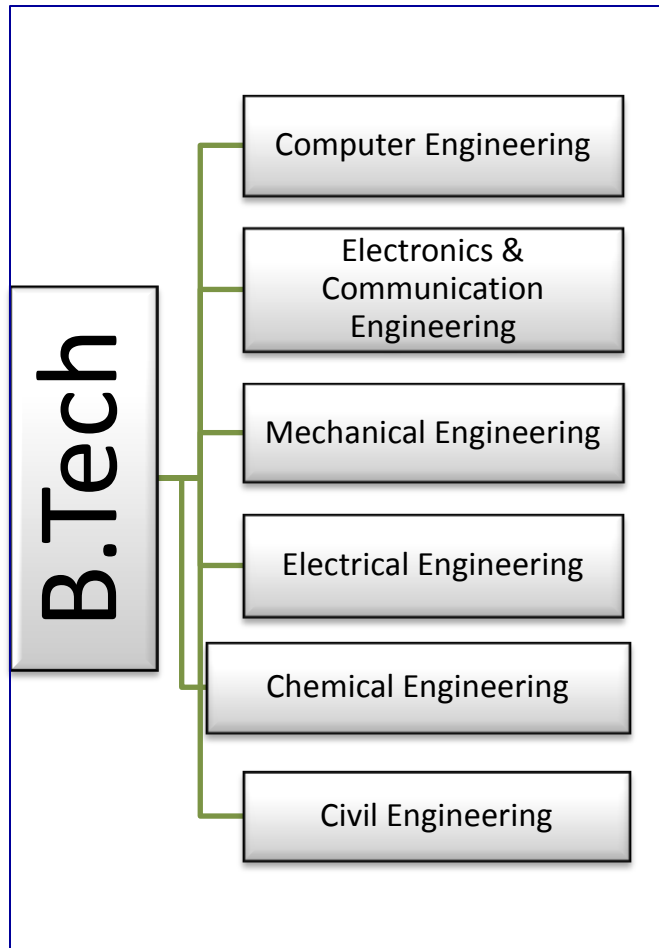

# Placement Till 2015:

Placements

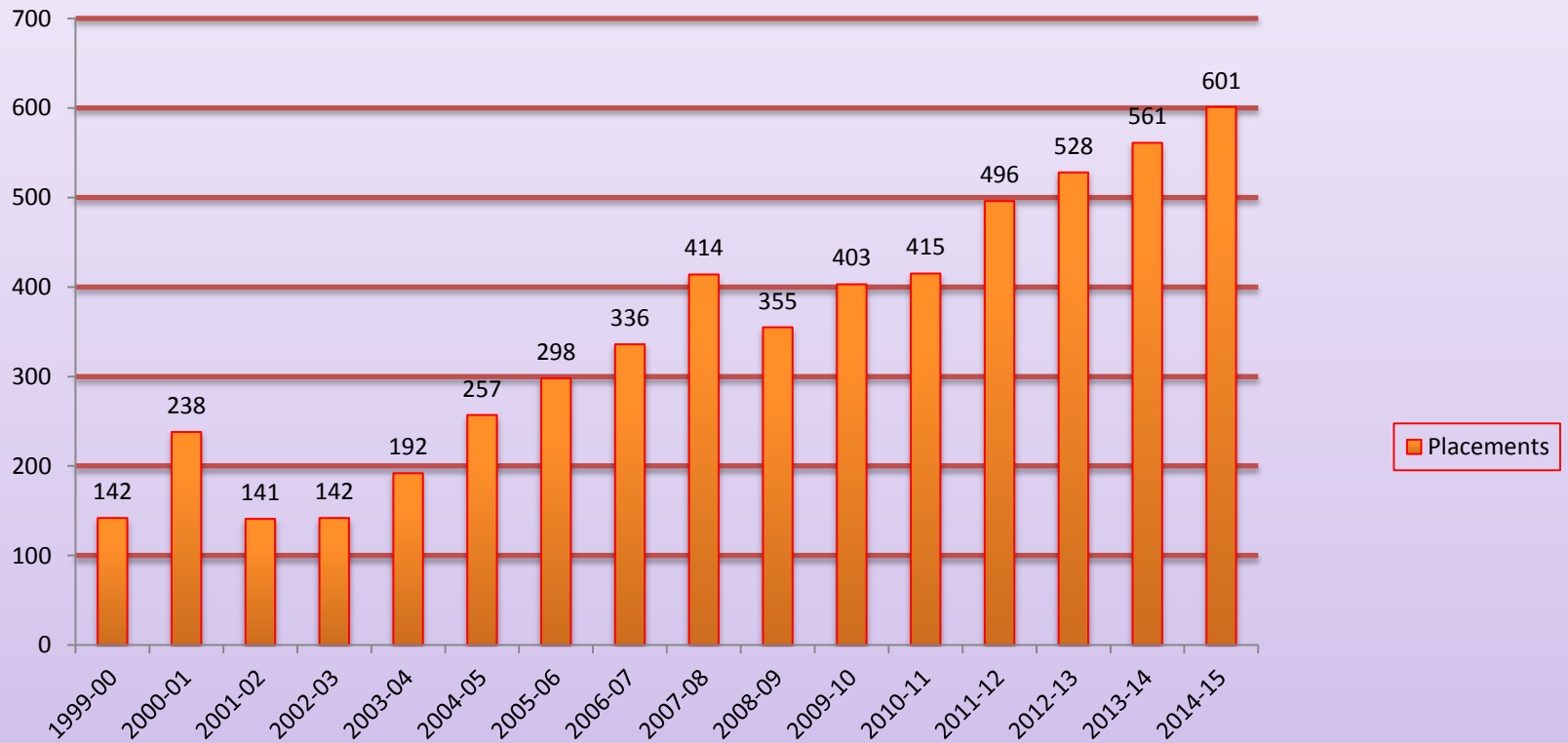

# Placement of PG (M.Tech.) students:

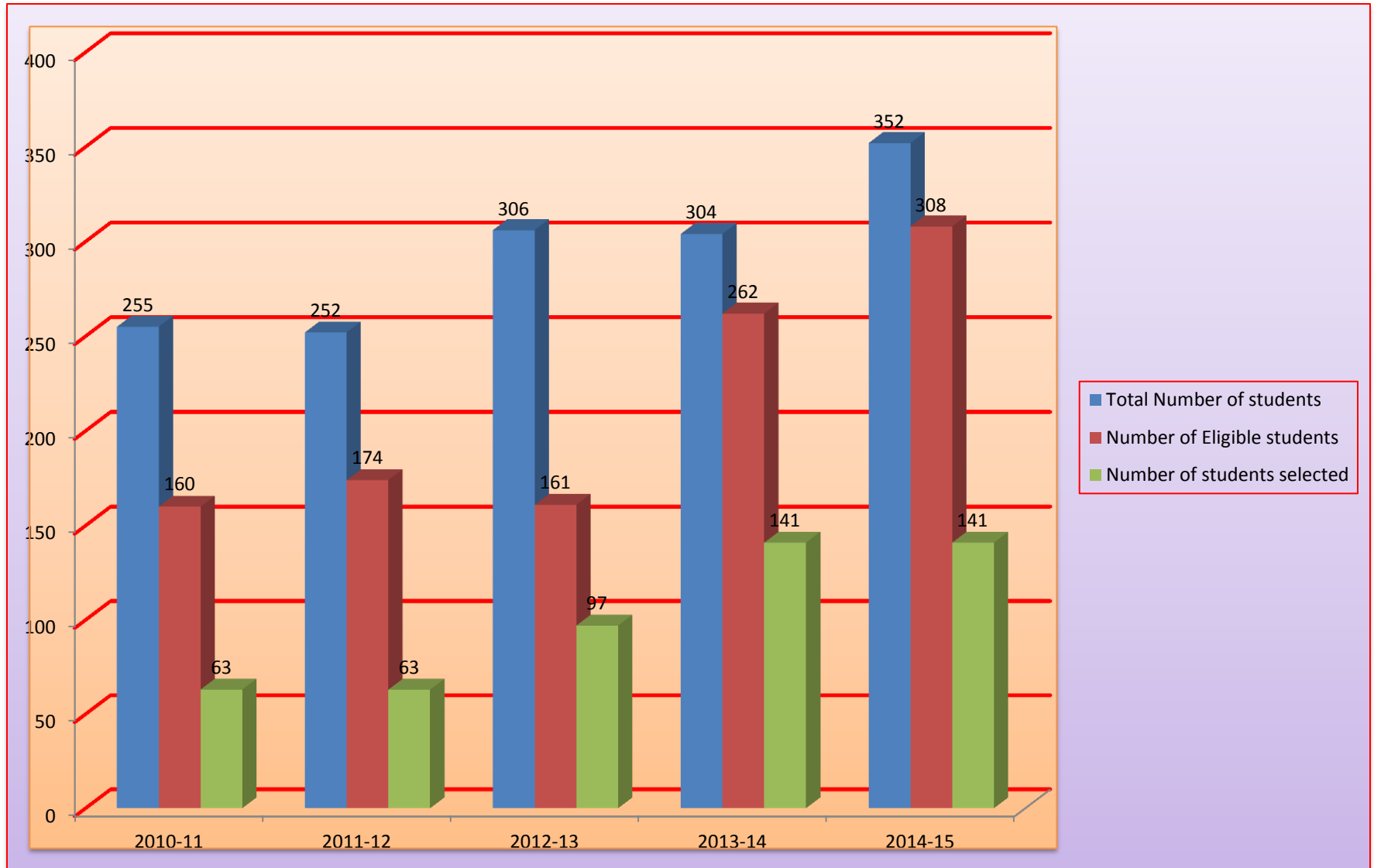

# Placement of UG(B.Tech.) Students:

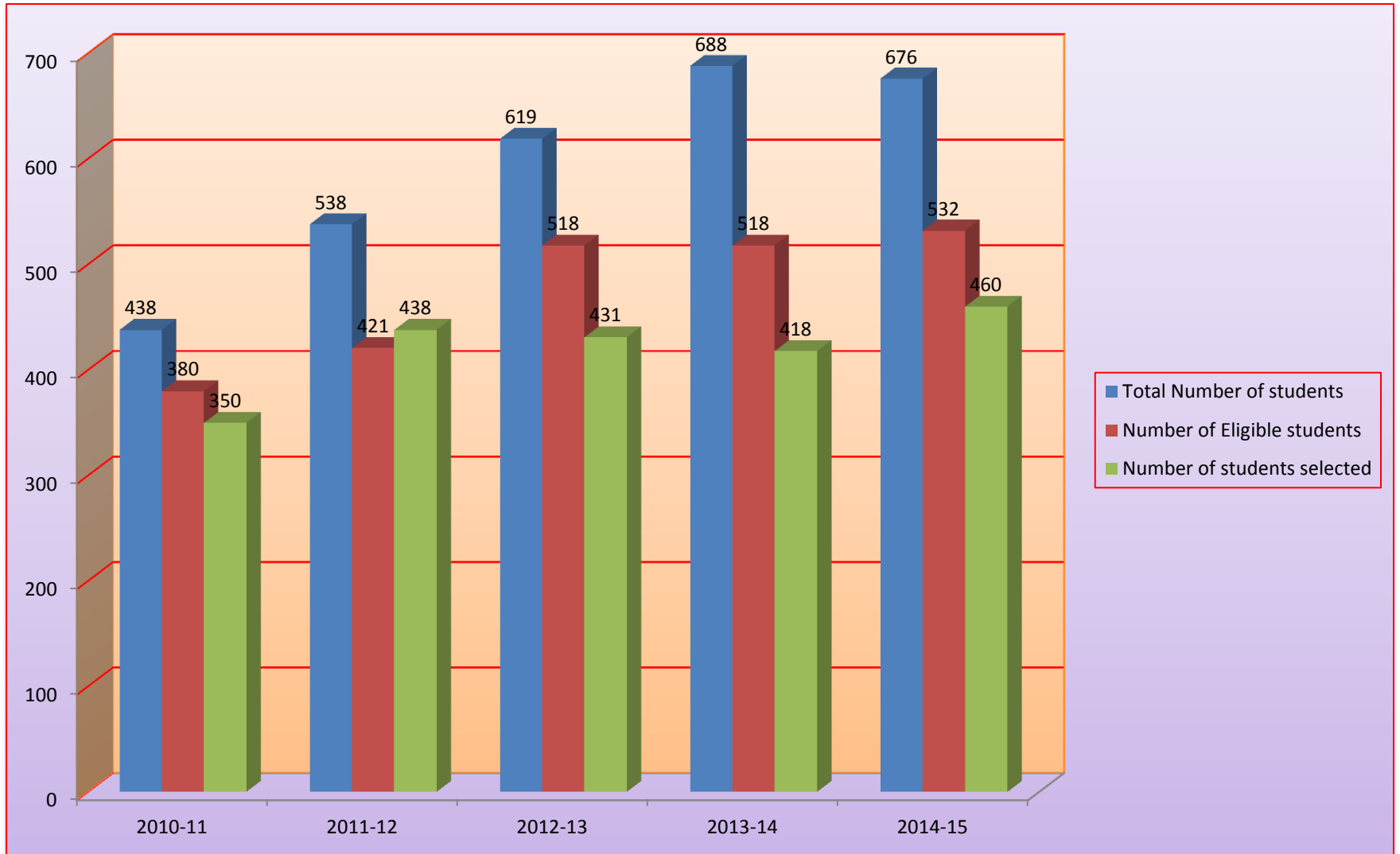

# Sector Wise Company Distribution for year 2014-15:

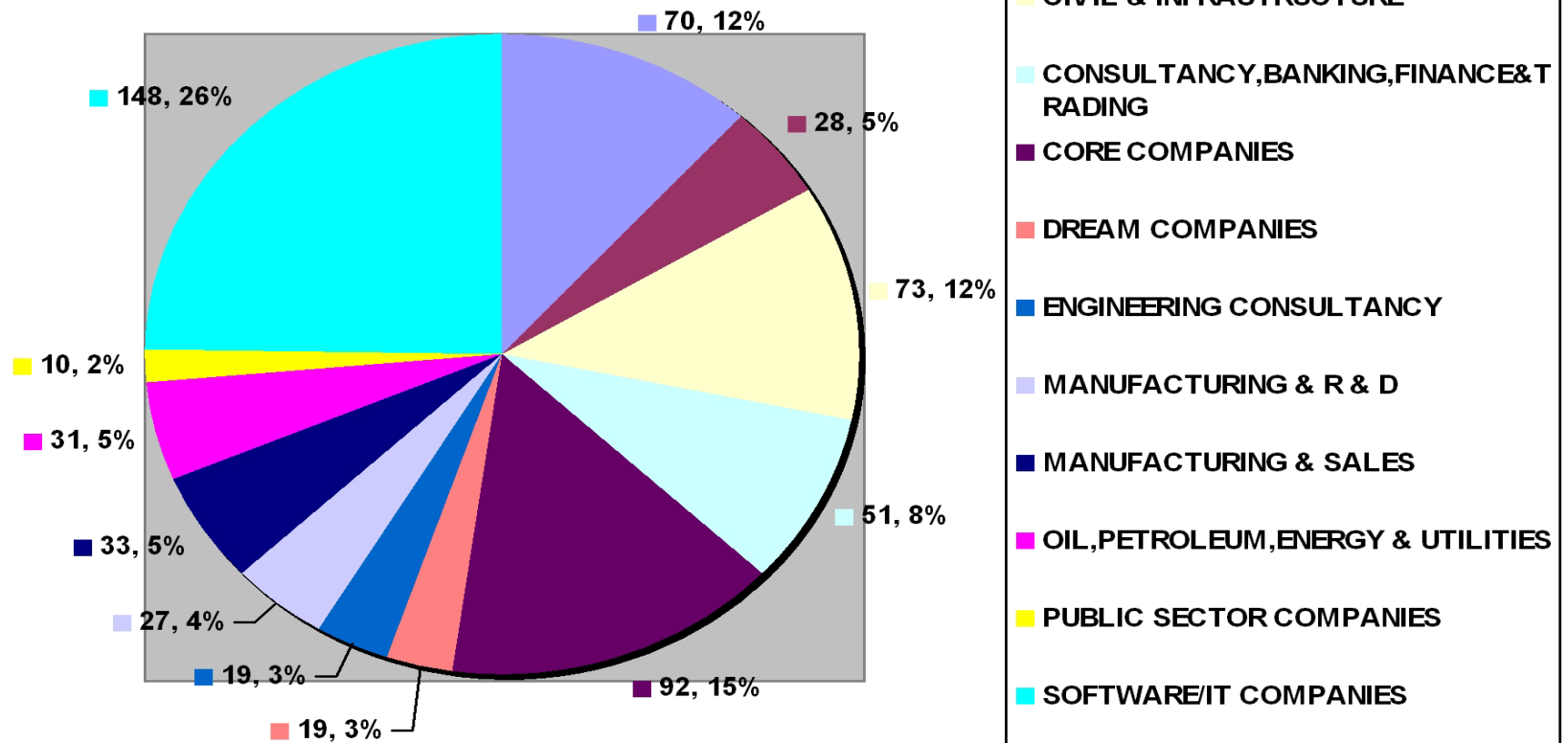

# CTC Wise Company Distribution for year 2014-15:

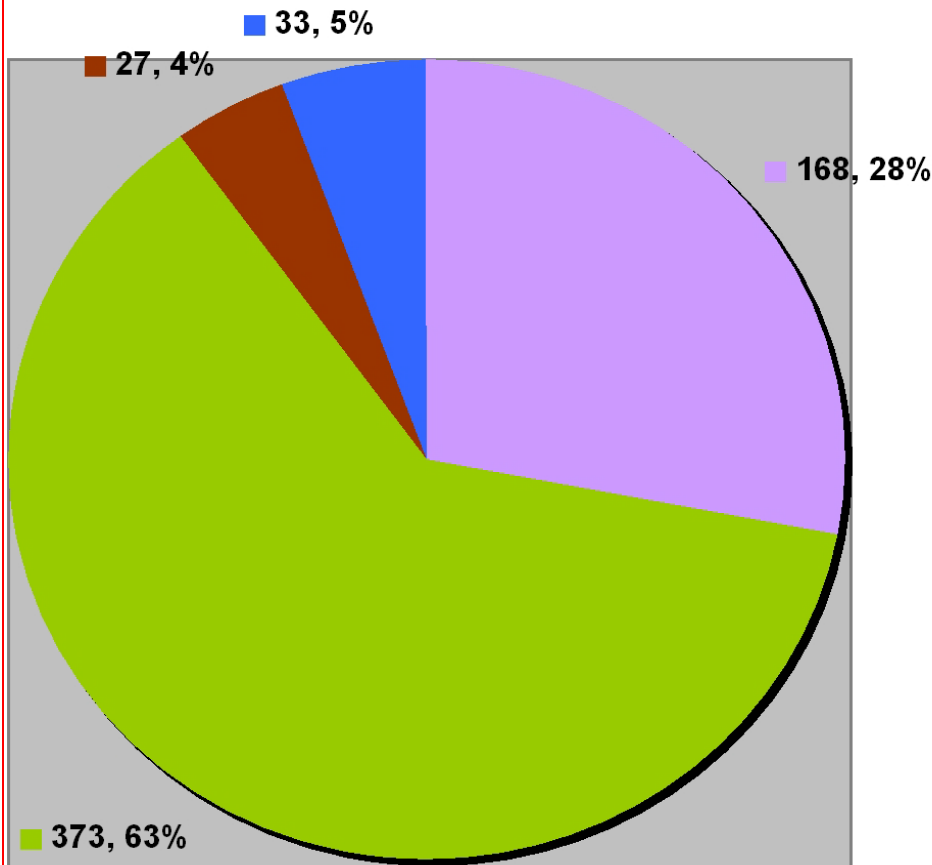

- Less than 4 Lac
- 4 to 7 Lac
- 7 to 9 Lac
- Above 9 Lac

# Branch-wise Placements of Batch 2014-15:

Number of Students Selected (Branch-wise/Course-wise) (B.Tech., M.Tech. & M.Sc.)																										
UG (B.Tech.) All branches						PG (M.Tech.) All courses																M.Sc. All courses		PhD.		
Computer	Electronics & Comm.	Electrical	Mechanical	Chemical	Civil	Computer	Comm. Sys.	VLSI	Power systems	PE&ED	Mechanical	Turbo.	Manufacturing	TSD	CAD/CAM	Structural	SMFE	Environ.	Urban Planning	WRE	TE&P	Chemical	Physics	Chemistry	Mathematics	PHD.CAD/CAM
65	107	58	138	42	50	10	5	10	7	8	11	7	11	12	3	9	4	11	7	7	9	2	5	0	2	1



# Average CTC Of B.Tech Branches 2014-15:

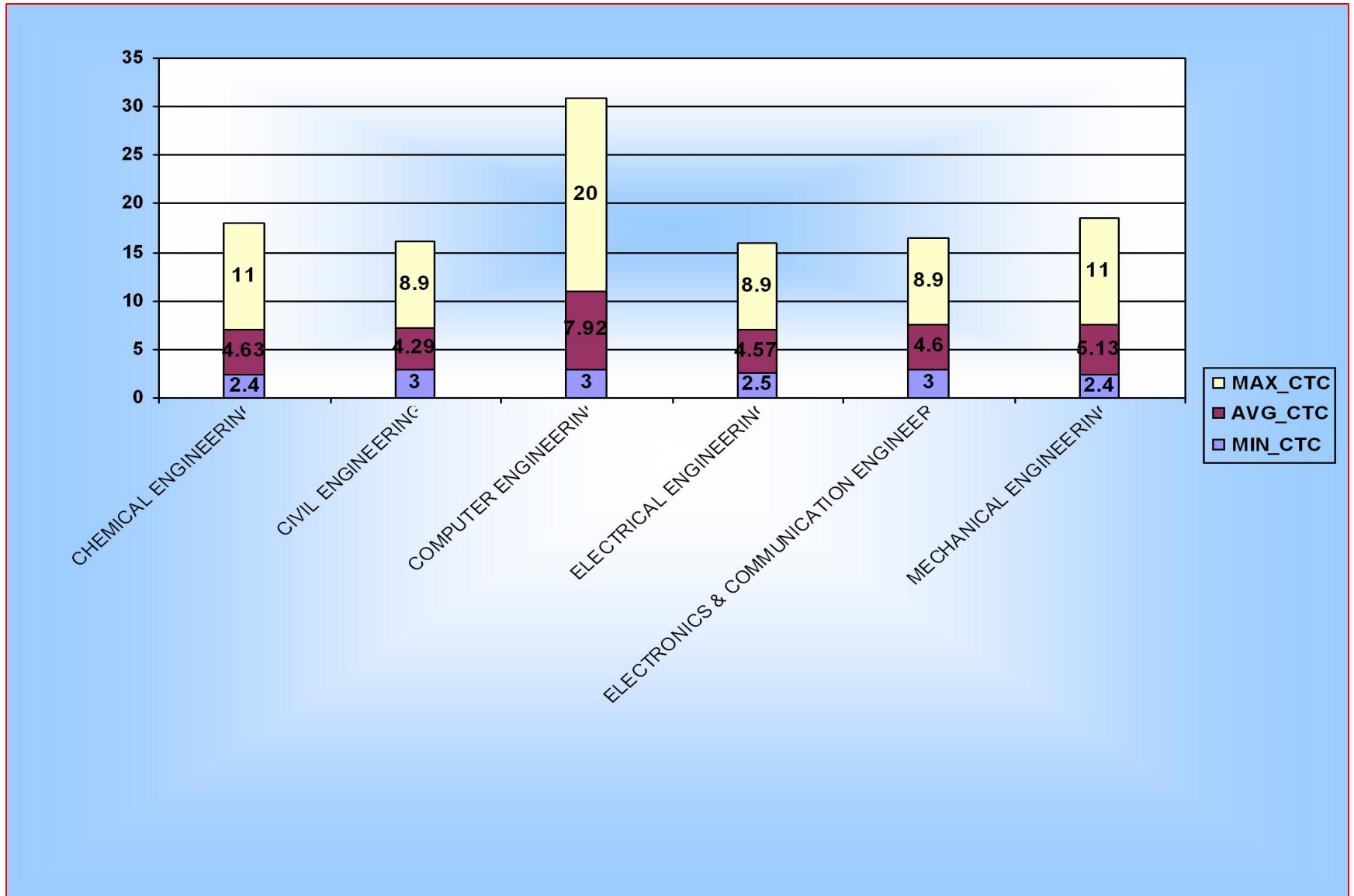

# Average CTC Of M.Tech Branches 2014-15:

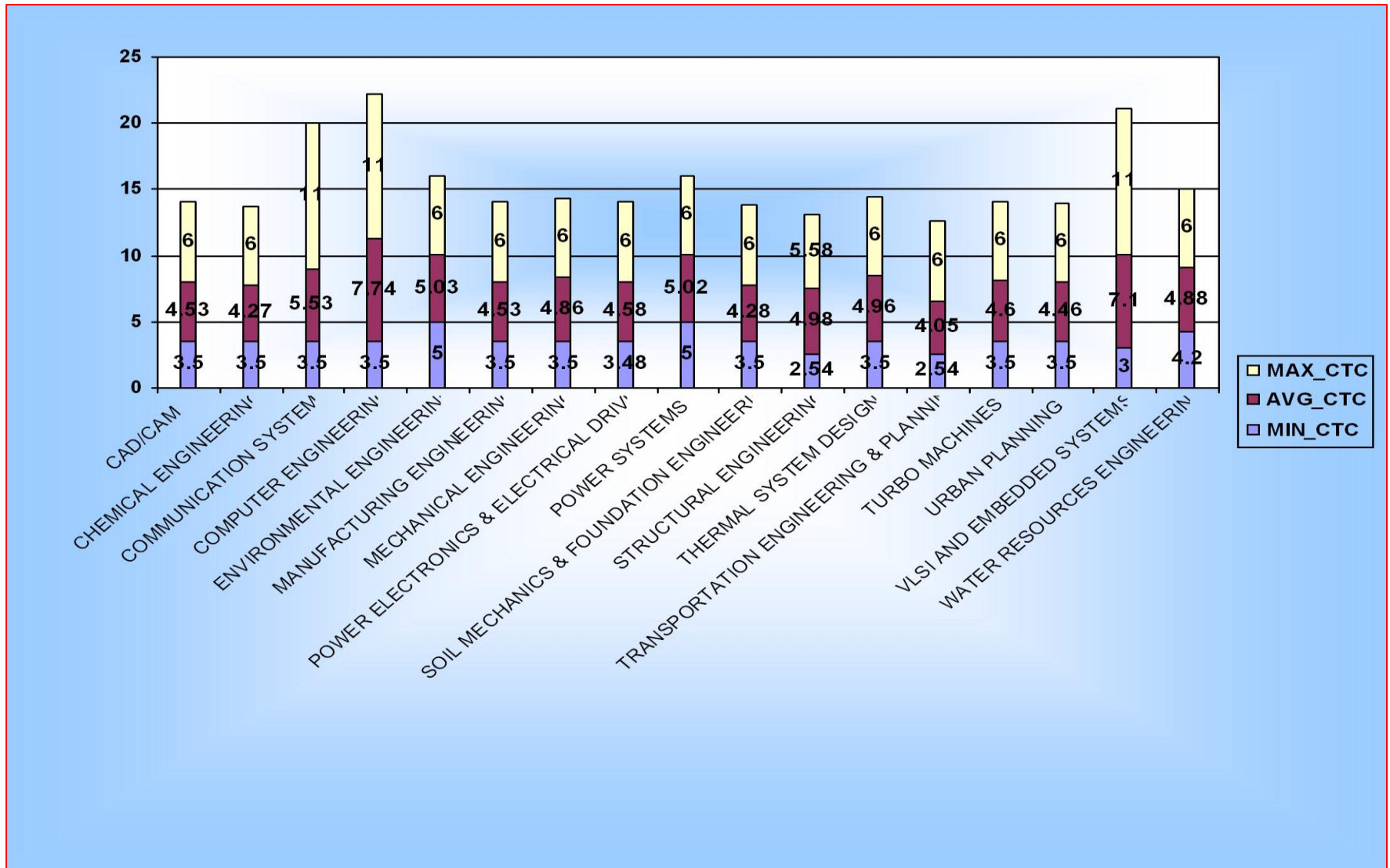

# Companies Hiring from our Institute



TATA TECHNOLOGIES





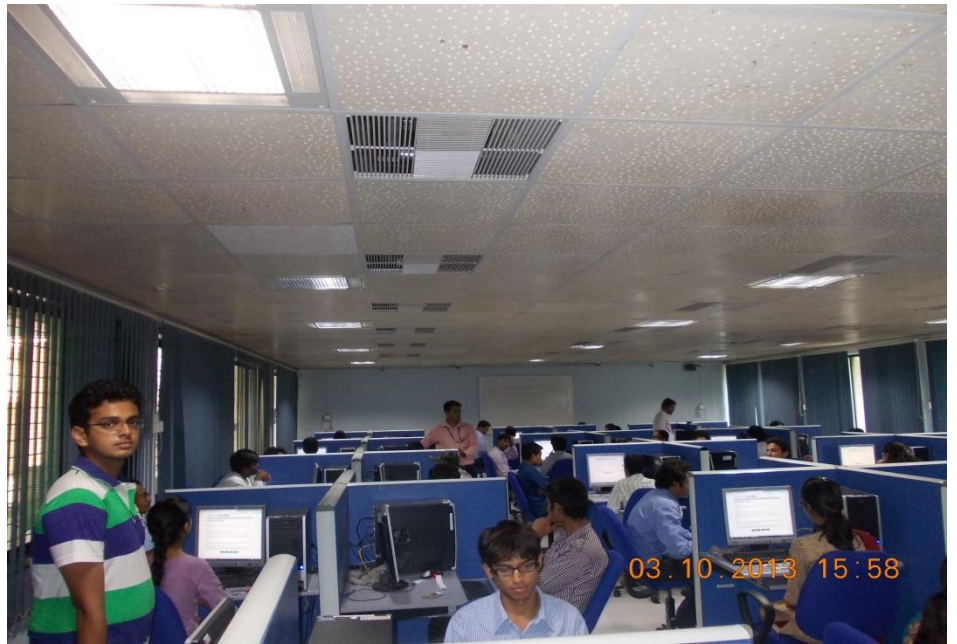





Placement Office:

Training & Placement Section

CAD-LAB-1,SVNIT,

Ichchanath Road, Surat, 395007

***BHARGVI JAGIRDAR***

***INSTITUTE PLACEMENT COORDINATOR***

***TRAINING & PLACEMENT SECTION.***

***tnp@svnit.ac.in/tnpnitsurat@gmail.com***

***9825689997/0261-2201540/0261-2255225***

***PROFESSOR I/C TRAINING & PLACEMENT SECTION***

***SHRI AMIT SOLANKI***

***09409237192/0261-2201606***

***ajs@ced.svnit.ac.in***

***DR.AJAY RAI***

***09904003860/0261-2201798***

***akr@ashd.svnit.ac.in***