

**AIPMT 2011**  
**PRELIM EXAMINATION**

**BIOLOGY**

**Q. 1.** The "Eyes" of the potato tuber are

1. Axillary buds
2. Root buds
3. Flower buds
4. Shoot buds

**Sol:**

Axillary buds developing at nodes/notch/eyes.

**Answer: (1)**

**Q. 2.** Organisms called Methanogens are most abundant in a

1. Hot spring
2. Sulphur rock
3. Cattle yard
4. Polluted stream

**Sol:**

Methanogens are archaebacteria abundant in cattle yard, and paddy fields.

**Answer: (3)**

**Q. 3.** Which one of the following have the highest number of species in nature?

1. Angiosperms
2. Fungi
3. Insects
4. Birds

**Sol:**

The largest phylum in animal kingdom is arthropoda, and the largest class is insecta with 7,50,000 species.

**Answer: (3)**

**Q. 4.** Archegoniophore is present in

1. Funaria
2. Marchantia
3. Chara
4. Adiantum

**Sol:**

Stalk bearing archegonial cluster at tip in Marchantia thallus

**Answer: (2)**

**Q. 5.** Compared with the gametophytes of the bryophytes the gametophytes of vascular plants tend to be

1. Smaller and to have smaller sex organs
2. Smaller but to have larger sex organs
3. Larger but to have smaller sex organs
4. Larger and to have larger sex organs

**Sol:**

Gametophytes are reduced and few celled in all vascular plants.

**Answer: (1)**

**Q. 6.** The gametophyte is not an independent, free-living generation in

1. Pinus
2. Polytrichum
3. Adiantum
4. Marchantia

**Sol:**

In gymnosperms and angiosperms gametophytes are dependent on sporophyte.

**Answer: (1)**

**Q. 7.** Important site for formation of glycoproteins and glycolipids is

1. Lysosome
2. Vacuole
3. Golgi apparatus
4. Plastid

**Sol:**

Golgi complex performs glycosyl transferase activity for addition of glycans on lipids and proteins.

**Answer: (3)**

**Q. 8.** Peptide synthesis inside a cell takes place in

1. Ribosomes
2. Chloroplast
3. Mitochondria
4. Chromoplast

**Sol:**

Ribosomes are site of peptide bond formation.

**Answer: (1)**

**Q. 9.** In eubacteria, a cellular component that resembles eukaryotic cell is

1. Cell wall
2. Plasma membrane
3. Nucleus
4. Ribosomes

**Sol:**

Lipoprotein cell membrane is found in both but ribosomes are of different kinds.

**Answer: (2)**

**Q. 10.** Mutations can be induced with

1. Gamma radiations
2. Infra Red radiations
3. I A A
4. Ethylene

**Sol:**

Mutation can be induced with high energy radiations like UV rays, gamma rays, which cause change in the structure of DNA.

**Answer: (1) Q. 11.** A collection of plants and seeds having diverse alleles of all the genes of a crop is called

1. Genome
2. Herbarium
3. Germplasm
4. Gene library

**Sol:**

Germplasm can be selected as seed or plantlets for their superior traits.

**Answer: (3)**

**Q. 12.** Which one of the following also acts as a catalyst in a bacterial cell?

1. 23 sr RNA
2. 5 sr RNA
3. sn RNA
4. hn RNA

**Sol:**

23 S rRNA is catalytic RNA.

**Answer: (1)**

**Q. 13.** Which one of the following statements is **correct**?

1. Flower of tulip is a modified shoot
2. In tomato, fruit is a capsule
3. Seeds of orchids have oil-rich endosperms
4. Placentation in *primrose* is basal

**Sol:**

Tomato — Berry, Orchid seed — no endosperm formation, Primrose — Free central placentation.

**Answer: (1)**

**Q. 14.** The correct floral formula of chilli is

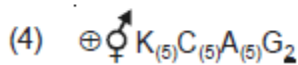
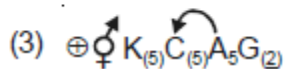
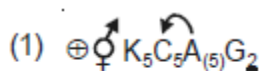

**Sol:**

Chilli belongs to Solanaceae.

**Answer: (3)**

**Q. 15.** Nitrifying bacteria

1. Reduce nitrates to free nitrogen
2. Oxidize ammonia to nitrates
3. Convert free nitrogen to nitrogen compounds
4. Convert proteins into ammonia

**Sol:**

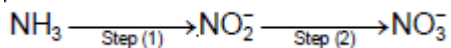

Step (1) — Nitrification by Nitrosomonas

Step (2) — Nitrification by Nitrocystis

**Answer: (2)**

**Q. 16.** The function of leghaemoglobin in the root nodules of legumes is

1. Expression of nif gene
2. Inhibition of nitrogenase activity
3. Oxygen removal
4. Nodule differentiation

**Sol:**

LHB is O<sub>2</sub> scavenger.

**Answer: (3)**

**Q. 17.** Which one of the following elements in plants is not remobilised?

1. Sulphur
2. Phosphorus
3. Calcium
4. Potassium

**Sol:**

Calcium is not remobilised, as it is a structural component in cell.

**Answer: (3)**

**Q. 18.** A drupe develops in

1. Tomato
2. Mango
3. Wheat
4. Pea

**Sol:**

Tomato — Berry, Wheat — Caryopsis, Pea — Legume

**Answer: (2)**

**Q. 19.** Ground tissue includes

1. All tissues internal to endodermis
2. All tissues external to endodermis
3. All tissues except epidermis and vascular bundles
4. Epidermis and cortex

**Sol:**

Ground tissue system includes — cortex, endoderm, pericycle and pith.

**Answer: (3)**

**Q. 20 .** In land plants the guard cells differ from other epidermal cells in having

1. Chloroplasts
2. Cytoskeleton
3. Mitochondria
4. Endoplasmic reticulum

**Sol:**

Guard cells are specialised chlorophyllous epidermal cells.

**Answer: (1)**

**Q. 21.** The ovary is half inferior in flowers of

1. Guava
2. Peach
3. Cucumber
4. Cotton

**Sol:**

Ovary is half inferior in perigynous flowers.

**Answer: (2)**

**Q. 22.** The cork cambium, cork and secondary cortex are collectively called

1. Phellem
2. Phelloderm
3. Phellogen
4. Periderm

**Sol:**

Phellem, phellogen and phelloderm are collectively called periderm.

**Answer: (4)**

**Q. 23.** Which one of the following is **wrongly** matched?

1. Cassia – Imbricate aestivation
2. Root pressure – Guttation
3. Puccinia – Smut
4. Root – Exarch protoxylem

**Sol:**

Puccinia — rust fungi.

**Answer: (3)**

**Q 24.** Flowers are Zygomorphic in

1. Datura
2. Mustard
3. Gulmohur
4. Tomato

**Sol:**

Datura, mustard and tomato have actinomorphic flowers.

**Answer: (3)**

**Q. 25.** CAM helps the plants in

1. Reproduction



2. Conserving water
3. Secondary growth
4. Disease resistance

**Sol:**

These are succulent plants with water storing cells.

**Answer: (2)**

**Q. 26.** Of the total incident solar radiation the proportion of PAR is

1. More than 80%
2. About 70%
3. About 60%
4. Less than 50%

**Sol:**

Plants capture 2-10% of PAR.

**Answer: (4)**

**Q. 27.** A prokaryotic autotrophic nitrogen fixing symbiont found in

1. Pisum
2. Alnus
3. Cycas
4. Cicer

**Sol:**

Anabaena cycadae is a BGA found in coralloid roots of Cycas

**Answer: (3)**

**Q. 28.** Nucellar polyembryony is reported in species of

1. Brassica
2. Citrus

3. Gossypium
4. Triticum

**Sol:**

Nucellus polyembryony is common in Citrus, mango and Opuntia.

**Answer: (2)**

**Q. 29.** Filiform apparatus is a characteristic feature of

1. Zygote
2. Suspensor
3. Egg
4. Synergid

**Sol:**

These are finger like projections at micropylar end of synergids.

**Answer: (4)**

**Q .30.** What would be the number of chromosomes of the aleurone cells of a plant with 42 chromosomes in its roots tip cells?

1. 21
2. 42
3. 63
4. 84

**Sol:**

Aleurone is triploid and root tip is diploid.

**Answer: (3)**

**Q .31.** Wind pollination is common in

1. Orchids
2. Legumes
3. Lilies
4. Grasses

**Sol:**

Wind pollination is common in grasses and gymnosperms.

**Answer: (4)**

**Q .32.** In which one of the following pollination is autogamous?

1. Cleistogamy
2. Geitonogamy
3. Xenogamy
4. Chasmogamy

**Sol:**

Self pollination is favoured by cleistogamy.

**Answer: (1)**

**Q .33.** Mass of living matter at a trophic level in an area at any time is called

1. Standing state
2. Standing crop
3. Detritus
4. Humus

**Sol:**

Standing state represent all non-living matter in an area at a given time.

**Answer: (2)**

**Q .34.** Which one of the following statements is wrong in case of Bhopal tragedy?

1. It took place in the night of December 2/3/1984
2. Methyl Isocyanate gas leakage took place
3. Thousands of human beings died
4. Radioactive fall out engulfed Bhopal

**Sol:**

It was not a tragedy related to radioactivity

**Answer: (4)**

**Q. 35.** Secondary sewage treatment is mainly a

1. Biological process
2. Physical process
3. Mechanical process
4. Chemical process

**Sol:**

Secondary sewage treatment involves aerobic and anaerobic microbes.

**Answer: (1)**

**Q. 36.** Eutrophication is often seen in

1. Mountains
2. Deserts
3. Fresh water lakes
4. Ocean

**Sol:**

It is process of enrichment of lakes by phosphates, nitrates etc.

**Answer: (3)**

**Q. 37.** Large Woody Vines are more commonly found in

1. Alpine forests
2. Temperate forests
3. Mangroves
4. Tropical rainforests

**Sol:**

Lianas and epiphytes are more common in tropical rain forest.

**Answer: (4)**

**Q. 38.** Which one of the following expanded forms of the following acronyms is correct?

1. IUCN = International Union for Conservation of Nature and Natural Resources
2. IPCC = International Panel for Climate Change
3. UNEP = United Nations Environmental Policy
4. EPA = Environmental Pollution Agency

**Sol:**

IPCC — Intergovernmental Panel for Climate Change

**Answer: (1)**

**Q. 39.** Which one of the following statements is correct for secondary succession?

1. It is similar to primary succession except that it has a relatively fast pace
2. It begins on a bare rock
3. It occurs on a deforested site
4. It follows primary succession

**Sol:**

Secondary biotic succession occurs in abandoned farm lands, burned or cut forests and lands that have been flooded.

**Answer: (3)**

**Q. 40.** Which one of the following shows maximum genetic diversity in India?

1. Mango
2. Groundnut
3. Rice
4. Maize

**Sol:**

Rice has more than 50,000 genetically different strains, while mango has 1000 varieties in India.

**Answer: (3)**

**Q. 41.** Which one of the following is not a biofertilizer?

1. Mycorrhiza
2. Agrobacterium
3. Rhizobium
4. Nostoc

**Sol:**

Agrobacterium is a gene transfer agent.

**Answer: (2)**

**Q. 42.** Which one of the following acts as a physiological barrier to the entry of microorganisms in human body?

1. Skin
2. Epithelium of Urogenial tract
3. Tears
4. Monocytes

**Sol:**

Physiological barriers to the entry of micro-organisms in human body are tears in eyes, saliva in mouth and HCl in stomach.

**Answer: (3)**

**Q. 43.** Which one of the following helps in absorption of phosphorus from soil by plants?

1. Anabaena
2. Glomus
3. Rhizobium
4. Frankia

**Sol:**

Glomus is an endomycorrhiza for phosphorus absorption.

**Answer: (2)**

**Q. 44.** 'Himgiri' developed by hybridisation and selection for disease resistance against rust pathogens is a variety of

1. Wheat
2. Chilli
3. Maize
4. Sugarcane

**Sol:**

This variety is resistant against leaf and stripe rust, hill bunt.

**Answer: (1)**

**Q. 45.** Which of the followings is mainly produced by the activity of anaerobic bacteria on sewage?

1. Marsh gas
2. Laughing gas
3. Propane
4. Mustard gas

**Sol:**

It is by the activity of methanogens.

**Answer: (1)**

**Q. 46.** Agarose extracted from sea weeds finds use in

1. Gel electrophoresis
2. Spectrophotometry
3. Tissue culture
4. PCR

**Sol:**

Agarose extracted from sea weeds finds use in gel electrophoresis.

**Answer: (1)**

**Q. 47.** Maximum number of existing transgenic animals is of

1. Pig
2. Fish
3. Mice
4. Cow

**Sol:**

95% of the existing transgenic animals are mice.

**Answer: (3)**

**Q. 48.** Continuous addition of sugars in 'fed batch' fermentation is done to

1. Degrade sewage
2. Produce methane
3. Obtain antibiotics
4. Purify enzymes

**Sol:**

Continuous addition of sugar in fed 'batch' fermentation is done to purify enzymes.

**Answer: (4)**

**Q. 49.** The process of RNA interference has been used in the development of plants resistant to

1. Insects
2. Nematodes
3. Fungi
4. Viruses

**Sol:**

RNAi *i.e.*, RNA interference is used in the development of plants resistant to nematode like *Meloidegynne incognita*.

**Answer: (2)**



**Q. 50.** "Jaya" and "Ratna" developed for green revolution in India are the varieties of

1. Bajra
2. Maize
3. Rice
4. Wheat

**Sol:**

Jaya and Ratna are released throughout the rice growing belts of India.

**Answer: (3)**

**Q. 51.** Which one of the following organisms is not an example of eukaryotic cells

1. Amoeba proteus
2. Paramecium caudatum
3. Paramecium caudatum
4. Euglena viridis

**Sol:**

E. coli is a prokaryotic bacterium.

**Answer: (3)**

**Q. 52.** Which one of the following animals is correctly matched with its particular named taxonomic category?

1. Housefly - Musca, an order
2. Tiger - Tigris, the species
3. Cuttlefish - Mollusca, a class
4. Humans - Primata, the family

**Sol:**

The zoological name of tiger is *Panthera tigris* in which *Panthera* is genus and *tigris* is species.

**Answer: (2)**

**Q. 53.** In which one of the following the genus name, its two characters and its class/phylum are correctly matched?

Genus name	Two characters	Class/ Phylum
(1) Aurelia	(a) cnidoblasts (b) Organ level of organization	Coelenterata
(2) Ascaris	(a) Body segmented (b) Males and females distinct	Annelida
(3) Salamandra	(a) A tympanum represents ear (b) Fertilization is external	Amphibia
(4) Pteropus	(a) Skin possesses hair (b) Oviparous	Amphibia

**Sol:**

Salamandra is a tailed amphibian, has tymphanum which represents ear.

**Answer: (3)**

**Q. 54.** Which one of the following groups of animals is correctly matched with its one characteristic feature without even a single exception?

1. Mammalia: give birth to young ones
2. Reptilia : possess 3-chambered heart with one incompletely divided ventricle
3. Chordata : possess a mouth provided with an upper and a lower jaw
- 4.

**Sol:**

All chondrichthyes possess cartilaginous endoskeleton without exception

**Answer: (4)**

**Q. 55.** What will you look for to identify the sex of the following?

1. Male shark - Claspers borne on pelvic fins
2. Female *Ascaris* - Sharply curved posterior end
3. Male frog - A copulatory pad on the first digit of the hind limb
4. Female cockroach - Anal cerci

**Sol:**

In class chondrichthyes males possess claspers on the pelvic fins.

**Answer: (1)**

**Q. 56.** The curve given below show enzymatic activity with relation to three conditions (pH, temperature and substrate concentration)

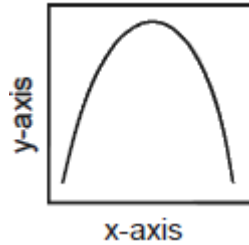

What do the two axes(x and y) represent?

**x-axis**

1. Enzymatic activity
2. Enzymatic activity
3. Temperature Enzyme
4. Substrate concentration

**y-axis**

1. Temperature
2. pH
3. Activity
4. Enzymatic Activity

**Sol:**

X-axis represent temperature and Y-axis represent enzyme activity. All enzymes act at an optimum temperature, above and below this temperature the enzyme activity declines.

**Answer: (3)**

**Q. 57.** The ciliated columnar epithelial cells in humans are known to occur in

1. Fallopian tubes and urethra
2. Eustachian tube and stomach lining
3. Bronchioles and Fallopian tubes
4. Bile duct and oesophagus

**Sol:**

Ciliated columnar epithelium lines bronchioles and fallopian tubes.

**Answer: (3)**

**Q. 58.** Select the correct option with respect to mitosis

1. Chromosomes move to the spindle equator and get aligned along equatorial plate in metaphase
2. Chromatids separate but remain in the centre of the cell in anaphase
3. Chromatids start moving towards opposite poles in telophase
4. Golgi complex and endoplasmic reticulum are still visible at the end of prophase

**Sol:**

Chromatids show poleward movement in anaphase; golgi and ER disappears in late prophase.

**Answer: (1)**

**Q. 59.** Which one of the following structural formulae of two organic compounds is correctly identified along with its related function?

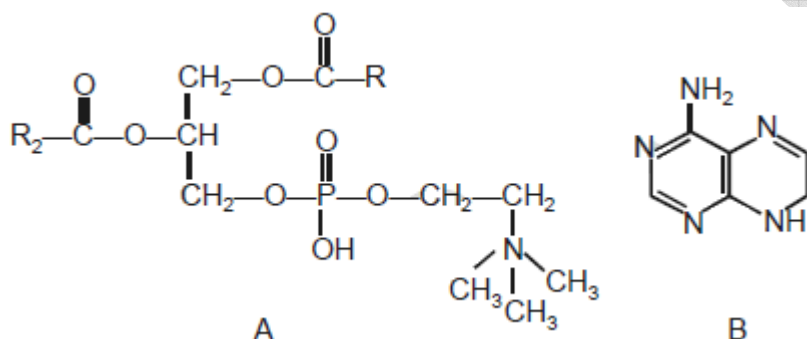

1. A: Lecithin - a component of cell membrane
2. B: Adenine - a nucleotide that makes up nucleic acids
3. A: Triglyceride - major source of energy
4. B: Uracil - a component of DNA

**Sol:**

A is the formula of Lecithin. Lecithin is a phospholipid and is the component of the cell membranes. B is the formula of adenine which is a nitrogenous base not a nucleotide.

**Answer: (1)**

**Q. 60.** What was the most significant trend in the evolution of modern man (*Homo sapiens*) from his ancestors?

1. Increasing brain capacity
2. Upright posture
3. Shortening of jaws

4. Binocular vision

**Sol:**

The most significant trend in the evolution of modern man (*Homo sapiens*) from the ancestors is increasing brain capacity.

**Answer: (1)**

**Q. 61.** Which one of the following conditions correctly describes the manner of determining the sex in the given example?

1. Homozygous sex chromosomes (XX) produce male in *Drosophila*
2. Homozygous sex chromosomes (ZZ) determine female sex in birds
3. XO type of sex chromosomes determine male sex in grasshopper
4. XO condition in humans as found in Turner Syndrome, determines female sex

**Sol:**

X/A ratio determines sex in *Drosophila* ♀ ; is heterogametic (ZW) in birds. In 'XO type' the 'O' determines maleness.

**Answer: (3)**

**Q. 62.** A person with unknown blood group under ABO system, has suffered much blood loss in an accident and needs immediate blood transfusion. His one friend who has a valid certificate of his own blood type, offers for blood donation without delay. What would have been the type of blood group of the donor friend?

1. Type A
2. Type B
3. Type AB
4. Type O

**Sol:**

The person with blood group O is said to be universal donor, because in this, there are no antigens on the surface of RBC.

**Answer: (4)**

**Q. 63.** What are those structures that appear as 'beads-on-string' in the chromosomes when viewed under electron microscope?

1. Base pairs

2. Genes
3. Nucleotides
4. Nucleosomes

**Sol:**

Nucleosome consist of octameric histone core wrapped by dsDNA

**Answer: (4)**

**Q. 64.**

Match the source gland with its respective hormone as well as the function

Source gland	Hormone	Function
Thyroid	Thyroxine	Regulates blood calcium level
Anterior pituitary	Oxytocin	Contraction of uterus muscles during child birth
Posterior pituitary	Vasopressin	Stimulates resorption of water in the distal tubules in the nephron
Corpus luteum	Estrogen	Supports pregnancy

**Sol:**

Vasopressin (ADH) is synthesised in hypothalamus but released into the blood from posterior lobe of pituitary,so it is called as a hormone of posterior lobe. It stimulates reabsorption of water in distal tubules in the nephron.

**Answer: (3)**

**Q. 65.** Which of the following is **correctly** stated as happens in the common cockroach?

1. The food is ground by mandibles an gizzard
2. Malpighian tubules are excretory organ projecting out from the colon
3. Oxygen is transported by haemoglobin blood
4. Nitrogenous excretory product is urea

**Sol:**

In cockroach the food is grinded by mandibles and gizzard. In insects there is no oxygen transporting pigment and nitrogenous excretory product is uric acid.

**Answer: (1)**

**Q. 66.** A large proportion of oxygen is left unused the human blood even after its uptake by the body tissues. This O<sub>2</sub>

5. Helps in releasing more O<sub>2</sub> to the epithelium tissues
6. Acts as a reserve during muscular exercise
7. Raises the pCO<sub>2</sub> of blood to 75 mm of Hg
8. Is enough to keep oxyhaemoglobin saturation at 96%

**Sol:**

Our tissues are able to utilise only 25% of O<sub>2</sub> carried by arterial blood. Our venous blood is still 75% saturated with O<sub>2</sub>. This O<sub>2</sub> acts as a reserve during muscular exercise.

**Answer: (2)**

**Q. 67.** Which one of the following enzymes carries on the initial step in the digestion of milk in humans?

1. Trypsin
2. Pepsin
3. Rennin
4. Lipase

**Sol:**

In humans milk protein digesting enzyme in stomach is pepsin. In calves it is rennin. Rennin is also present in small amounts in human infants but not adults. Pepsin acts on water soluble caseinogen (milk protein) to form solubles 'casein'. This combines with calcium salts to form insoluble calcium paracaseinate, which gets readily digested enzymatically.

**Answer: (2)**

**Q. 68.** Which one of the following is not a part of a renal pyramid?

1. Loops of Henle
2. Peritubular capillaries
3. Convolute tubules
4. Collecting ducts

**Sol:**

In Bowman's capsule PCT and DCT are in renal cortex, whereas, loops of Henle are in medullary pyramids.

**Answer: (3)**

**Q. 69.** One very special feature in the earthworm pheretima is that

1. It has a long dorsal tubular heart
2. Fertilisation of eggs occurs inside the body
3. The typhlosole greatly increases the effective absorption area of the digested food in the intestine
4. The S-shaped setae embedded in the integument are the defensive weapons used against the enemies

**Sol:**

In earthworm, mid dorsal villi typhlosole greatly increases the effective absorption area of the digested food in the intestine

**Answer: (3)**

**Q. 70.** Two friends are eating together on a dining table. One of them suddenly starts coughing while swallowing some food. This coughing would have been due to improper movement of

1. Tongue
2. Epiglottis
3. Diaphragm
4. Neck

**Sol:**

If a person suddenly starts coughing while swallowing food, it is due to improper movement of epiglottis. If the glottis is not properly closed some food can enter respiratory tract.

**Answer: (2)**

**Q. 71.** Arteries are best defined as the vessels which

1. Carry blood from one visceral organ to another visceral organ
2. Supply oxygenated blood to the different organs
3. Carry blood away from the heart to different organs
4. Break up into capillaries which reunite to form a vein

**Sol:**

Arteries are best defined as vessels which carry blood away from the heart to different organs.



**Answer: (3)**

**Q. 72.** 'Bundle of His' is a part of which one of the following organs in humans?

1. Pancreas
2. Brain
3. Heart
4. Kidney

**Sol:**

'Bundle of His' is a part of conducting system of human heart.

**Answer: (3)**

**Q. 73.** The purplish red pigment rhodopsin contained in the rods type of photoreceptor cells of the human eye, is a derivative of

1. Vitamin A
2. Vitamin B1
3. Vitamin C
4. Vitamin D

**Sol:**

Vitamin A is the precursor of the purplish red pigment rhodopsin contained in the rods (photoreceptor) cells of human eye.

**Answer: (1)**

**Q. 74.** Which one of the following plasma proteins is involved in the coagulation of blood?

1. Fibrinogen
2. An albumin
3. Serum amylase
4. A globulin

**Sol:**

Fibrinogen is a plasma protein involved in clotting of blood.

**Answer: (1)**

**Q. 75.** When a neuron is in resting state i.e. not conducting any impulse, the axonal membrane is

1. Comparatively more permeable to  $K^+$  ions and nearly impermeable to  $Na^+$  ions
2. Comparatively more permeable to  $Na^+$  ions and nearly impermeable to  $K^+$  ions
3. Equally permeable to both  $Na^+$  and  $K^+$  ions
4. Impermeable to both  $Na^+$  and  $K^+$  ions

**Sol:**

When a neuron is in resting state *i.e.*, not conducting any impulse, the axonal membrane is comparatively more permeable to  $K^+$  ions and nearly impermeable to  $Na^+$  ions.

**Answer: (1)**

**Q. 76.** Which one of following **correctly** explains the function of a specific part of a human nephron?

1. Afferent arteriole : Carries the blood away from the glomerulus towards renal vein
2. Podocytes : Create minute spaces (slit pores) for the filtration of blood into the Bowman's capsule
3. Henle's loop : Most reabsorption of the major substances from the glomerular filtrate
4. Distal convoluted tubule: Reabsorption of  $K^+$  ions into the surrounding blood capillaries

**Sol:**

Podocytes are specialised squamous epithelial cells in the inner wall of Bowman's capsule. They give rise to foot like processes which form filtration slits for the filtration of blood into the Bowman's capsule.

**Answer: (2)**

**Q. 77.** Given below is an incomplete table about certain hormones, their source glands and one major effect of each on the body in humans. Identify the correct option for the three blanks A, B and C

GLANDS	SECRETION	EFFECT ON BODY
A	Oestrogen	Maintenance of secondary sexual characters
Alpha cells of Islets of Langerhans	B	Raises blood sugar level
Anterior pituitary	C	Over secretion leads to gigantism

**Options**

A	B	C
1. Placenta	Glucagon	Calcitonin
2. Ovary Glucagon	Growth	hormone
3. Placenta	Insulin	Vasopressin
4. Ovary	Insulin	Calcitonin

**Sol:**

A. Ovary secretes oestrogen for maintenance of secondary sexual characters.

B. Alpha cells of Islets of Langerhans secrete glucagon which raises blood sugar level.

C. Anterior lobe of pituitary secretes growth hormone. Its over secretion leads to gigantism.

**Answer: (2)**

**Q. 78.** Uricotelic mode of passing out nitrogenous wastes is found in

1. Insects and Amphibians
2. Reptiles and Birds
3. Birds and Annelids
4. Amphibians and Reptiles

**Sol:**

Reptiles and birds are uricotelic.

**Answer: (2)**

**Q. 79.** The figure given below shows a small part of human lung where exchange of gases takes place. In which one of the options given below, the one part A, B, C or D is **correctly** identified along with its function?

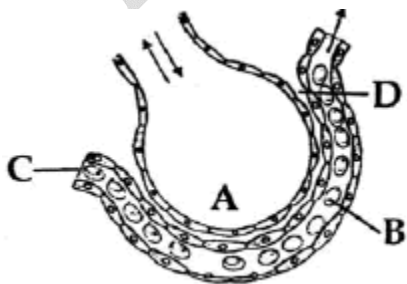

1. **B:** Red blood cell - transport of CO<sub>2</sub> mainly

2. **C:** Arterial capillary - passes oxygen to tissues
3. **A:** alveolar cavity - main site of exchange of respiratory gases
4. **D :** Capillary wall - exchange of O<sub>2</sub> and CO<sub>2</sub> takes place here

**Sol:**

A is the alveolar cavity which is the main site of exchange of respiratory gases.

**Answer: (3)**

**Q. 80.** Which one of the following statements is correct regarding blood

1. 190/110 mmHg may harm vital organs like brain and kidney
2. 130/90 mmHg is considered high and requires treatment
3. 100/55 mmHg is considered an ideal blood pressure
4. 105/50 mmHg makes one very active

**Sol:**

Hypertension occurs if the blood pressure is 190/110. This can harm the vital organs like brain and kidneys.

**Answer: (1)**

**Q. 81.** Which one of the following statements is **correct** with respect to kidney function regulation?

1. During summer when body loses lot of water by evaporation, the release of ADH is suppressed
2. When someone drinks lot of water, ADH release is suppressed
3. Exposure to cold temperature stimulates ADH release
4. An increase in glomerular blood flow stimulates formation of Angiotensin II

**Sol:**

When someone drinks lot of water which is not required by his body, the osmolarity of the blood will decrease. The decrease in osmolarity will inhibit the release of ADH. ADH not released DCT becomes less permeable to water, and excess of water is eliminated.

**Answer: (2)**

**Q. 82.** The figure given below depicts a diagrammatic sectional view of the female reproductive system of humans. Which one set of three parts out of I – VI have been **correctly** identified?

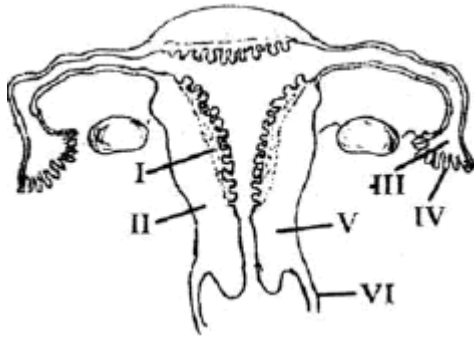

1. Perimetrium, (II) Myometrium, (III) Fallopian tube
2. (II) Endometrium, (III) Infundibulum, (IV) Fimbriae
3. (III) Infundibulum, (IV) Fimbriae, (V) Cervix
4. (IV) Oviducal funnel, (V) Uterus, (VI) Cervix

**Sol:**

III is infundibulum

IV is fimbriae

V is cervix

**Answer: (3)**

**Q. 83.** The testes in humans are situated outside the abdominal cavity inside a pouch called scrotum. The purpose served is for

1. Providing a secondary sexual feature for exhibiting the male sex
2. Maintaining the scrotal temperature lower than the internal body temperature
3. Escaping any possible compression by the visceral organs
4. Providing more space for the growth of epididymis

**Sol:**

The testes in humans are situated outside the abdominal cavity in scrotal sacs. This is because the temperature of scrotal sacs is  $2.5^{\circ}\text{C}$  lesser than internal body temperature.

**Answer: (2)**

**Q. 84.** Which one of the following is the most widely accepted method of contraception in India, as at present?

1. IUDs' (Intra uterine devices)
2. Cervical caps
3. Tubectomy
4. Diaphragms

**Sol:**

The most widely accepted method of contraception in India is IUDs.

**Answer: (1)**

**Q. 85.** If for some reason, the vasa efferentia in the human reproductive system get blocked, the gametes will not be transported from

1. Vagina to uterus
2. Testes to epididymis
3. Epididymis to vas deferens
4. Ovary to uterus

**Sol:**

The path of transport of gametes is Seminiferous tubules → rete testis → vasa efferentia → epididymis. So, if vasa efferentia are blocked the gametes from testes will not enter epididymis.

**Answer: (2)**

**Q. 86.** Medical Termination of Pregnancy (MTP) is considered safe up to how many weeks of pregnancy?

1. Six weeks
2. Eight weeks
3. Twelve weeks
4. Eighteen weeks

**Sol:**

MTPs are considered safe upto twelve weeks of pregnancy.

**Answer: (3)**

**Q. 87.** Which one of the following is categorised as a parasite in **true sense**?

1. The cuckoo (koel) lays its egg in crow's nest
2. The female Anopheles bites and sucks blood from humans
3. Human foetus developing inside the uterus draws nourishment from the mother
4. Head louse living on the human scalp as well as laying eggs on human hair

**Sol:**

Head louse living on the human scalp as well as laying eggs on human hair is a parasite in true sense. Female mosquito is not considered as a parasite, though it needs human blood for reproduction. Koel that lays in crow's nest is just a brood parasite.

**Answer: (4)**

**Q. 88.** What type of human population is represented by the following pyramid?

1. Expanding population
2. Vanishing population
3. Stable population
4. Declining population

**Sol:**

It is an Urn shaped pyramid with least number of pre-reproductive individuals.

**Answer: (4)**

**Q. 89.** Which one of the following statements for pyramid of energy is **incorrect**, whereas the remaining three are correct?

1. It is upright in shape
2. Its base is broad
3. It shows energy content of different trophic level organisms
4. It is inverted in shape

**Sol:**

It is never inverted.

**Answer: (4)**

**Q. 90.** Ethanol is commercially produced through a particular species of

1. Aspergillus
2. Aspergillus
3. Clostridium
4. Trichoderma

**Sol:**

Yeast species.

**Answer: (2)**

**Q. 91.** Consider the following four conditions (a - d) and select the correct pair of them as adaptation to environment in desert lizards.

**The conditions**

- (a) Burrowing in soil to escape high temperature
- (b) Losing heat rapidly from the body during high temperature
- (c) Bask in sun when temperature is low
- (d) Insulating body due to thick fatty dermis

1. (a), (b)
2. (c), (d)
3. (a), (c)
4. (b), (d)

**Sol:**

The adaptations in desert lizard are

- (i) burrowing in soil to escape high temperature
- (ii) bask in sun when temperature is low

**Answer: (3)**



**Q. 92.** Which one of the following pairs of gases are the major cause of "Greenhouse Effect"?

1. CO<sub>2</sub> and N<sub>2</sub>O
2. CO<sub>2</sub> and O<sub>3</sub>
3. CO<sub>2</sub> and CO
4. CFCs and SO<sub>2</sub>

**Sol:**

CO<sub>2</sub>, CH<sub>4</sub>, N<sub>2</sub>O and CFC are common green house gases.

**Answer: (1)**

**Q. 93.** Where will you look for the sporozoites of the malarial parasite?

1. Salivary glands of freshly moulted female *Anopheles* mosquito
2. Saliva of infected female *Anopheles* mosquito
3. Red blood corpuscles of humans suffering from malaria
4. Spleen of infected humans

**Sol:**

Sporozoites are the infective stage of malarial parasite. They present in the saliva of infected female *Anopheles* mosquito.

**Answer: (2)**

**Q. 94.** When two unrelated individuals or lines are crossed, the performance of F<sub>1</sub> hybrid is often superior to both its parents. This phenomenon is called

1. Metamorphosis
2. Heterosis
3. Transformation
4. Spheing

**Sol:**

Heterosis is equivalent to hybrid vigour.

**Answer: (2)**

**Q. 95.** A certain patient is suspected to be suffering from Acquired Immuno Deficiency Syndrome. Which diagnostic technique will you recommend for its detection?

1. WIDAL
2. ELISA
3. MRI
4. Ultra sound

**Sol:**

ELISA is a diagnostic test for AIDS.

**Answer: (2)**

**Q. 96.** At which stage of HIV infection does one usually show symptoms of AIDS?

1. Within 15 days of sexual contact with an infected person
2. When the infecting retrovirus enters host cells
3. When viral DNA is produced by reverse transcriptase
4. When HIV replicates rapidly in helper T-lymphocytes and damages large number of these

**Sol:**

Symptoms of AIDs appear when there is depletion of helper T-cells.

**Answer: (4)**

**Q. 97.** Given below is a sample of a portion of DNA strand giving the base sequence on the opposite strands. What is so special shown in it?

5' \_\_\_\_\_ GAATTC \_\_\_\_\_ 3'

3' \_\_\_\_\_ CTTAAG \_\_\_\_\_ 5'

1. Palindromic sequence of base pairs
2. Replication completed
3. Deletion mutation
4. Start codon at the 5' end

**Sol:**

5' \_\_\_\_\_ GAATTC \_\_\_\_\_ 3'

3' \_\_\_\_\_ CTTAAG \_\_\_\_\_ 5'

is the palindromic sequence, recognised by EcoRI.

**Answer: (1)**

**Q. 98.** The most common substrate used in distilleries for the production of ethanol is

1. Molasses
2. Corn meal
3. Soya meal
4. Ground gram

**Sol:**

Molasses are used commonly in distilleries for ethanol production

**Answer: (1)**

**Q. 99.** An organism used as biofertilizer for raising soyabean crop is

1. Nostoc
2. Azotobacter
3. Azospirillum
4. Rhizobium

**Sol:**

Soyabean is a legume associated symbiotically with Rhizobium.

**Answer: (4)**

**Q. 100.** There is a restriction endonuclease called *EcoRI*. What does "co" part in it stand for?

1. coli
2. colon
3. coelom

4. coenzyme

**Sol:**

In EcoRI, 'co' stands for coli (species of bacteria, from where it is obtained)

**Answer: (3)**

### CHEMISTRY

**Q. 1.** The total number of atomic orbitals in fourth energy level of an atom is

- (1) 4 (2) 8  
(3) 16 (4) 32

**Sol:**

Number of atomic orbitals in an orbit =  $n^2 = 4^2 = 16$

**Answer : (3)**

**Q. 2.** The electrode potentials for  $\text{Cu}^{2+}_{(\text{aq})} + \text{e}^- \rightarrow \text{Cu}^{2+}_{(\text{aq})}$  and  $\text{Cu}^{2+}_{(\text{aq})} + \text{e}^- \rightarrow \text{Cu(s)}$  are +0.15 V and +0.50 V respectively. The value of  $E^{\circ}_{\text{Cu}^{2+}/\text{Cu}}$ .

- (1) 0.150 V (2) 0.500 V  
(3) 0.325 V (4) 0.650 V

**sol.**

$$\begin{aligned}\Delta G_3 &= \Delta G_1 + \Delta G_2 \\ \Rightarrow -2FE^{\circ} &= -1F \times 0.15 + (-1F \times 0.50) \\ \Rightarrow -2FE^{\circ} &= -0.15F - 0.50F \\ \Rightarrow -2FE^{\circ} &= -F(0.15 + 0.50) \\ \therefore E^{\circ} &= \frac{0.65}{2} = 0.325 \text{ volt}\end{aligned}$$

**Answer : (3)**

**Q. 3.** Mole fraction of the solute in a 1.00 molal aqueous solution is

- (1) 1.7700 (2) 0.1770  
(3) 0.0177 (4) 0.0344

**Sol.**

Mole fraction of solute =  $1/56.55 = 0.0177$

**Answer : (3)**

**Q. 4.** By what factors does the average velocity of a gaseous molecule increase when the temperature (in Kelvin) is doubled?

- (1) 1.4 (2) 2.0  
(3) 2.8 (4) 4.0

**Sol.**

$$\text{Average velocity} = \sqrt{\frac{8RT}{\pi M}}$$

**Answer : (1)**

**Q. 5.** A buffer solution is prepared in which the concentration of  $\text{NH}_3$  is 0.30 M and the concentration of  $\text{NH}_4^+$  is 0.20 M. If the equilibrium constant,  $K_b$  for  $\text{NH}_3$  equals  $1.8 \times 10^{-5}$ , what is the pH of this solution?

- (1) 8.73 (2) 9.08  
(3) 9.43 (4) 11.72

**Sol.**

$$\begin{aligned} \text{p}^{\text{OH}} &= \text{p}K_b + \log \frac{[\text{Salt}]}{[\text{Base}]} = 4.74 + \log \frac{0.20}{0.30} \\ &= 4.74 + (0.301 - 0.477) \\ &= 4.74 - 0.176 = 4.56 \\ \therefore \text{PH} &= 14 - 4.56 = 9.44 \end{aligned}$$

**Answer : (3)**



$$(1) \frac{1}{(k_1 K_2)}$$

$$(2) \frac{1}{(2k_1 K_2)}$$

$$(3) \frac{1}{(4k_1 K_2)}$$

$$(4) \left[ \frac{1}{k_1 K_2} \right]^{1/2}$$

**Sol:**

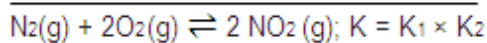
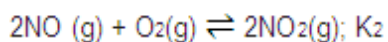
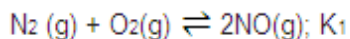

$$\therefore \text{For } \text{NO}_2(\text{g}) \rightleftharpoons \frac{1}{2} \text{N}_2(\text{g}) + \text{O}_2(\text{g}); K' = \left[ \frac{1}{K_1 K_2} \right]^{1/2}$$

**Answer : (4)**

**Q. 9.** If  $x$  is amount of adsorbate and  $m$  is amount of adsorbent, which of the following relations is not related to adsorption process?

$$(1) \frac{x}{m} = p \times T$$

$$(2) \frac{x}{m} = f(p) \text{ at constant } T$$

$$(3) \frac{x}{m} = f(T) \text{ at constant } p$$

$$(4) p = f(T) \text{ at constant } \left( \frac{x}{m} \right)$$

**Sol:**

$x/m = P \times T$  is the incorrect relation

**Answer : (1)**

**Q.10.** If the enthalpy change for the transition of liquid water to steam is  $30 \text{ kJ mol}^{-1}$  at  $27^\circ\text{C}$ , the entropy change for the process would be

$$(1) 100 \text{ J mol}^{-1} \text{ K}^{-1}$$

$$(2) 10 \text{ J mol}^{-1} \text{ K}^{-1}$$

$$(3) 1.0 \text{ J mol}^{-1} \text{ K}^{-1}$$

$$(4) 0.1 \text{ J mol}^{-1} \text{ K}^{-1}$$

**Sol:**

$$\Delta S_{\text{vap}} = \Delta \frac{H_{\text{vap}}}{T} = \frac{30 \text{ kJ mol}^{-1}}{300 \text{ K}} = 100 \text{ J mol}^{-1} \text{ K}^{-1}$$

**Answer : (1)**

**Q. 11.** The van't Hoff factor  $i$  for a compound which undergoes dissociation in one solvent and association in other solvent is respectively

- (1) Greater than one and greater than one
- (2) Less than one and greater than one
- (3) Less than one and less than one
- (4) Greater than one and less than one

**Sol .**

Fact

**Answer : (4)**

**Q. 12.** Standard electrode potential for  $\text{Sn}^{4+} / \text{Sn}^{2+}$  couple is +0.15 V and that for the  $\text{Cr}^{3+} / \text{Cr}$  couple is -0.74 V. These two couples in their standard state are connected to make a cell. The cell potential will be

- |             |             |
|-------------|-------------|
| (1) +1.83 V | (2) +1.19 V |
| (3) +0.89 V | (4) +0.18 V |

**Sol:**

$$\begin{aligned} E_{\text{cell}}^0 &= E_{\text{cathode(RP)}}^0 - E_{\text{anod(RP)}}^0 \\ &= 0.15 - (-0.74) \\ &= +0.89 \text{ V} \end{aligned}$$

**Answer : (3)**

**Q.13.** A gaseous mixture was prepared by taking equal mole of CO and N<sub>2</sub>. If the total pressure of the mixture was found 1 atmosphere, the partial pressure of the nitrogen (N<sub>2</sub>) in the mixture is



(1) 1 atm

(2) 0.5 atm

(3) 0.8 atm

(4) 0.9 atm

**Sol.**

Fact

**Answer : (2)**

**Q. 14.** If the  $E_{\text{cell}}^{\circ}$  for a given reaction has a negative value, then which of the following gives the correct relationships for the values of  $\Delta G^{\circ}$  and  $K_{\text{eq}}$ ?

(1)  $\Delta G^{\circ} > 0$ ;  $K_{\text{eq}} < 1$

(2)  $\Delta G^{\circ} > 0$ ;  $K_{\text{eq}} > 1$

(3)  $\Delta G^{\circ} < 0$ ;  $K_{\text{eq}} > 1$

(4)  $\Delta G^{\circ} < 0$ ;  $K_{\text{eq}} < 1$

**Sol:**

$$\therefore \Delta G^{\circ} = -nFE^{\circ} \text{ \& } \Delta G^{\circ} = -RT \log_e K_{\text{eq}}$$

**Answer : (1)**

**Q. 15.** The freezing point depression constant for water is  $-1.86^{\circ} \text{ cm}^{-1}$ . If 5.00 g  $\text{Na}_2\text{SO}_4$  is dissolved in 45.0 g  $\text{H}_2\text{O}$ , the freezing point is changed by  $-3.82^{\circ}\text{C}$ . Calculate the van't Hoff factor for  $\text{Na}_2\text{SO}_4$ .

(1) 0.381

(2) 2.05

(3) 2.63

(4) 3.11

**Sol:**

Using,  $\Delta T_f = i \times K_f \times m$

$$i = \frac{T_f \times W_A}{K_f \times n_B \times 1000} = \frac{3.82 \times 45}{1.86 \times \left(\frac{5}{142}\right) \times 1000} = 2.63$$

**Answer : (3)**

**Q. 16.** The energies  $E_1$  and  $E_2$  of two radiations are 25 eV and 50 eV respectively. The relation between their wavelengths i.e.  $\lambda_1$  and  $\lambda_2$  will be

(1)  $\lambda_1 = 1/2 \lambda_2$

(2)  $\lambda_1 = \lambda_2$

(3)  $\lambda_1 = 2\lambda_2$

(4)  $\lambda_1 = 4\lambda_2$

**Sol.**

(3)  $\lambda_1 = 2\lambda_2$

**Answer : (3)**

**Q. 17.** Standard electrode potential of three metals X, Y and Z are  $-1.2$  V,  $+0.5$  V and  $-3.0$  V respectively. The reducing power of these metals will be

(1)  $X > Y > Z$

(2)  $Y > Z > X$

(3)  $Y > X > Z$

(4)  $Z > X > Y$

**Sol.**

$Z > X > Y$ ; higher the reduction potential lesser the reducing power

**Answer : (4)**

**Q. 18.** Which one of the following statements for the order of a reaction is incorrect?

(1) Order of reaction is always whole number

(2) Order can be determined only experimentally

(3) Order is not influenced by stoichiometric coefficient of the reactants

(4) Order of reaction is sum of power to the concentration terms of reactants to express the rate of reaction

**Sol:**

Fact

**Answer : (1)**



**Sol.**

Zr and Ti are purified by van Arkel method

**Answer : (3)**

**Q. 23.** The correct order of increasing bond length of C – H, C – O, C – C and C = C is

(1) C -H < C - O < C - C < C = C

(2) C -H < C = C < C -O < C - C

(3) C -C < C = C < C - O < C -H

(4) C -O < C - H < C - C < C = C

**Sol.**

Fact

**Answer : (2)**

**Q. 24.** Acidified  $K_2Cr_2O_7$  solution turns green when  $Na_2SO_3$  is added to it. This is due to the formation of

(1)  $CrSO_4$

(2)  $Cr_2(SO_4)_3$

(3)  $CrO_4^{2-}$

(4)  $Cr_2(SO_3)_3$

**Sol.**

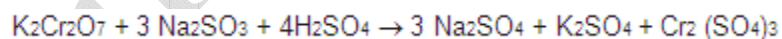

**Answer : (2)**

**Q. 25.** For the four successive transition elements (Cr, Mn, Fe and Co), the stability of + 2 oxidation state will be there in which of the following order?

(1)  $Cr > Mn > Co > Fe$

(2)  $Mn > Fe > Cr > Co$

(3)  $\text{Fe} > \text{Mn} > \text{Co} > \text{Cr}$

(4)  $\text{Co} > \text{Mn} > \text{Fe} > \text{Cr}$

(At. nos.  $\text{Cr} = 24$ ,  $\text{Mn} = 25$ ,  $\text{Fe} = 26$ ,  $\text{Co} = 27$ )

**Sol.**

On the basis of electrode potentials, the correct order is  $\text{Mn} > \text{Fe} > \text{Cr} > \text{Co}$

**Answer :** (2Q. 26. Which of the two ions from the list given below that have the geometry that is explained by the same hybridization of orbitals

$\text{NO}_2^-$ ,  $\text{NO}_3^-$ ,  $\text{NH}_2^-$ ,  $\text{NH}_4^+$ ,  $\text{SCN}^-$ ?

(1)  $\text{NO}_2^-$  and  $\text{NH}_2^-$

(2)  $\text{NO}_2^-$  and  $\text{NO}_3^-$

(3)  $\text{NH}_4^+$  and  $\text{NO}_3^-$

(4)  $\text{SCN}^-$  and  $\text{NH}_2^-$

**Sol.**

$\text{NO}_2^-$  and  $\text{NO}_3^-$  (-) both have same hybridization.

**Answer: (1)**

**Q. 27.** Which of the following elements is present as the impurity to the maximum extent in the pig iron?

(1) Phosphorus

(2) Manganese

(3) Carbon

(4) Silicon

**Sol:**

Fact

**Answer : (3)**

**Q. 28.** Which of the following is least likely to behave as Lewis base?

(1)  $\text{OH}^-$

(2)  $\text{H}_2\text{O}$

(3)  $\text{NH}_3$

(4)  $\text{BF}_3$

**Sol.**

$\text{BF}_3$  is an electron deficient species.

**Answer : (4)**

**Q. 29.** Which one of the following is present as an active ingredient in bleaching powder for bleaching action?

(1)  $\text{CaCl}_2$

(2)  $\text{CaOCl}_2$

(3)  $\text{Ca}(\text{OCl})_2$

(4)  $\text{CaO}_2\text{Cl}$

**Sol.**

Fact

**Answer : (3)**

**Q. 30.** The complex,  $[\text{Pt}(\text{Py})(\text{NH}_3)\text{BrCl}]$  will have how many geometrical isomers?

(1) 2

(2) 3

(3) 4

(4) 0

**Sol.**

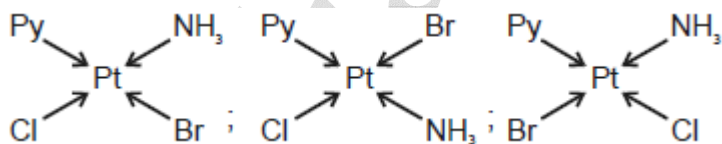

**Answer : (2)**

**Q. 31.** Name the type of the structure of silicate in which one oxygen atom of is shared?

(1) Three dimensional

(2) Linear chain silicate

(3) Sheet silicate

(4) Pyrosilicate

**Sol:**

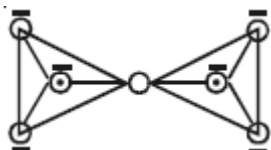

**Answer : (4)**

**Q. 32.** The complexes  $[\text{Co}(\text{NH}_3)_6][\text{Cr}(\text{CN})_6]$  and  $[\text{Cr}(\text{NH}_3)_6][\text{Co}(\text{CN})_6]$  are the examples of which type of isomerism?

- (1) Geometrical isomerism                      (2) Linkage isomerism  
 (3) Ionization isomerism                      (4) Coordination isomerism

**Sol:**

Co-ordination isomerism

**Answer(4)**

**Q. 33.** The d-electron configurations of  $\text{Cr}^{2+}$ ,  $\text{Mn}^{2+}$ ,  $\text{Fe}^{2+}$  and  $\text{Co}^{2+}$  are  $d^4$ ,  $d^5$ ,  $d^6$ , and  $d^7$  respectively. Which one of the following will exhibit minimum paramagnetic behaviour?

- (1)  $[\text{Cr}(\text{H}_2\text{O})_6]^{2+}$                                       (2)  $[\text{Mn}(\text{H}_2\text{O})_6]^{2+}$   
 (3)  $[\text{Fe}(\text{H}_2\text{O})_6]^{2+}$                                       (4)  $[\text{Co}(\text{H}_2\text{O})_6]^{2+}$

(At. nos. Cr = 24, Mn = 25, Fe = 26, Co = 27)

**Sol:**

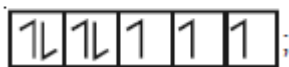
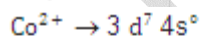

having minimum no. of unpaired electrons

**Answer : (4)**

**Q. 34.** Of the following complex ions, which is diamagnetic in nature?

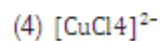
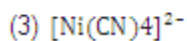
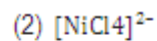
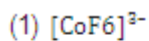

**Sol:**

Ni has  $dsp^2$  hybridisation where  $\text{CN}^{(-)}$  is a strong ligand

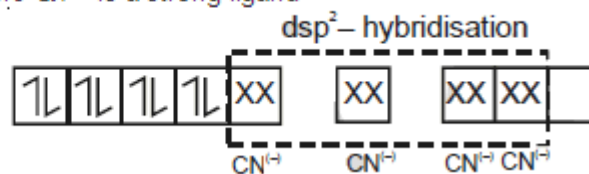

**Answer : (3)**

**Q. 35.** Which of the following has the minimum bond length?

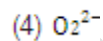

**Sol:**

$\text{O}_2^+$  has B.O 2.5 and  $\text{B.O} \propto \frac{1}{\text{Bond Length}}$

**Answer : (4)**

**Q. 36.** The value of  $\Delta H$  for the reaction

$\text{X}_2(\text{g}) + 4\text{Y}_2(\text{g}) \rightleftharpoons 2\text{XY}_4(\text{g})$  is less than zero. Formation of  $\text{XY}_4(\text{g})$  will be favoured at

(1) High pressure and low temperature

(2) High temperature and high pressure

(3) Low pressure and low temperature

(4) High temperature and low pressure

**Sol:**

$\Delta n_g = -ve$  and  $\Delta H = -ve$

**Answer : (1)**







**Answer : (3)**

**Q. 41.** Which one of the following is most reactive towards electrophilic reagent ?

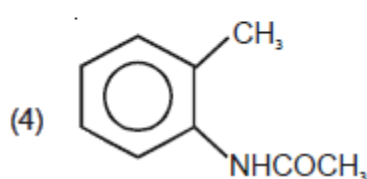
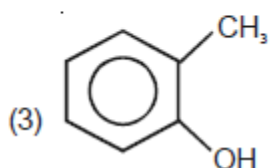
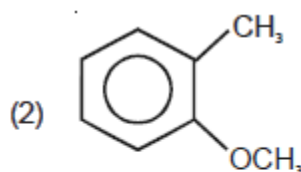
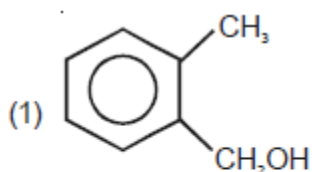

**Sol .**

+R effect of OH > OCH<sub>3</sub>

**Answer : (3)**

**Q. 42.** Which one is a nucleophilic substitution reaction among the following?

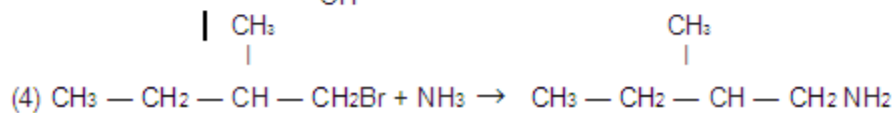
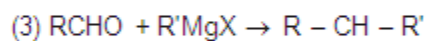
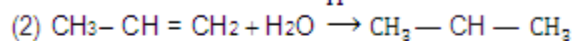
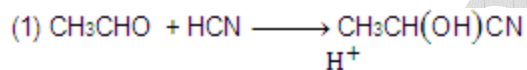

**Sol.**

Fact

**Answer : (4)**

**Q. 43.** Considering the state of hybridization of carbon atoms, find out the molecule among the following which is linear?

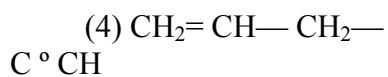
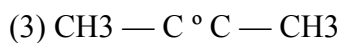
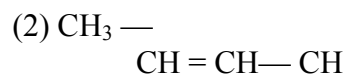
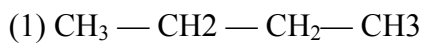

Sol.

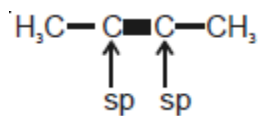

Answer: (3)

Q. 44. In the following reactions,

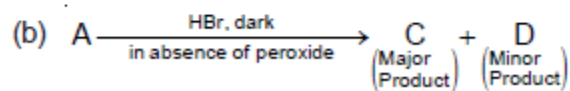
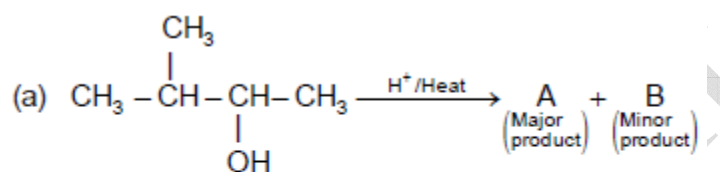



(3) Helps in the precipitation of AgCl

(4) Increases the solubility product of AgCl

**Sol .**

Fact

**Answer: (2)**

**Q. 46.** The correct IUPAC name of the compound

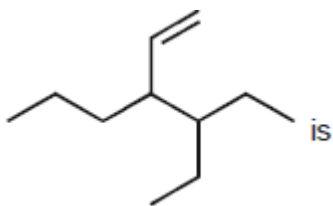

(1) 3-(1-ethyl propyl) hex-1-ene

(2) 4-Ethyl-3-propyl hex-1-ene

(3) 3-Ethyl-4-ethenyl heptane

(4) 3-Ethyl-4-propyl hex-5-ene

**Sol.**

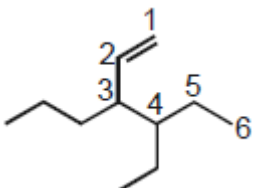

4-Ethyl-3-propylhex-1-ene

**Answer : (2)**

**Q. 47.** Clemmensen reduction of a ketone is carried out in the presence of which of the following?

(1) H<sub>2</sub> and Pt as catalyst

(2) Glycol with KOH

(3) Zn-Hg with HCl

(4) LiAlH<sub>4</sub>

**Sol .**

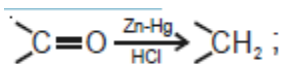

**Answer : (3)**

**Q. 48.** Which one of the following is employed as Antihistamine?

- (1) Omeprazole (2) Chloramphenicol  
(3) Diphenyl hydramine (4) Norothindrone

**Sol:**

Diphenyl hydramine is employed as Antihistamine

**Answer : (3)**

**Q. 49.** Which one of the following statements is not true regarding (+) Lactose?

- (1) (+) Lactose,  $C_{12}H_{22}O_{11}$  contains 8-OH groups  
(2) On hydrolysis (+) Lactose gives equal amount of D(+) glucose and D(+) galactose  
(3) (+) Lactose is a  $\beta$ -glycoside formed by the union of a molecule of D(+) glucose and a molecule of D(+) galactose  
(4) (+) Lactose is reducing sugar and does not exhibit mutarotation

**Sol:**

(+) lactose is a reducing sugar and it exhibit mutarotation

**Answer : (4)**

**Q. 50.** Which one of the following statement is no true?

- (1) Oxides of sulphur, nitrogen and carbon are the most widespread air pollutant

(2) pH of drinking water should be between 5.5 – 9.5

(3) Concentration of DO below 6 ppm is good for the growth of fish

(4) Clean water would have a BOD value of less than 5 ppm

**Sol:**

Fact

**Answer : (3)**

### PHYSICS

**Q.1.** The dimensions of  $(\mu_0 \epsilon_0)^{-1/2}$  are:

(1)  $[L^{-1/2} T^{1/2}]$

(2)  $[L^{1/2} T^{-1/2}]$

(3)  $[L^{-1} T]$

(4)  $[L T^{-1}]$

**Sol:**

Given expression is that of speed of light.

**Answer: (4)**

**Q. 2.** The moment of inertia of a thin uniform rod of mass M and length L about an axis passing through its midpoint and perpendicular to its length is  $I_0$ . Its moment of inertia about an axis passing through one of its ends and perpendicular to its length is

**Sol:**

(1)  $I_0 + ML^2$

(2)  $I_0 + \frac{ML^2}{2}$

(3)  $I_0 + \frac{ML^2}{4}$

(4)  $I_0 + 2ML^2$

**Answer : (3)**

$$I = I_{CM} + Mh^2 \text{ (Parallel axis theorem)}$$



**Q. 3.** A boy standing at the top of a tower of 20 m height drops a stone. Assuming  $g = 10 \text{ ms}^{-2}$ , the velocity with which it hits the ground is

- (1) 5.0 m/s (2) 10.0 m/s  
(3) 20.0 m/s (4) 40.0 m/s

**Sol:**

**Answer : (3)**

$$V = \sqrt{2gh} = \sqrt{2 \times 10 \times 20} = 20 \text{ m/s}$$

**Q. 4.** A person of mass 60 kg is inside a lift of mass 940 kg and presses the button on one control panel. The lift starts moving upwards with an acceleration  $1.0 \text{ ms}^{-2}$ . If  $g = 10 \text{ ms}^{-2}$ , the tension in the supporting cable is :

- (1) 1200 N (2) 8600 N  
(3) 9680 N (4) 11000 N

**Sol:**

$$T = (M + m) (g + a) = (940 + 60) (10 + 1) = 11000 \text{ N}$$

**Answer (4)**

**Q. 5.** A body projected vertically from the earth reaches a height equal to earth's radius before returning to the earth. The power exerted by the gravitational force is greatest

- (1) At the instant just after the body is projected  
(2) At the highest position of the body  
(3) At the instant just before the body hits the earth  
(4) It remains constant all through

**Sol:**



**Sol.**

$$\text{Impulse} = MV - (-MV) = 2 MV$$

**Answer: (4)**

**Q.9 .** A planet moving along an elliptical orbit is closest to the sun at a distance  $r_1$  and farthest away at a distance of  $r_2$ . If  $v_1$  and  $v_2$  are the linear velocities at these points respectively. Then the ratio  $v_1/v_2$

(1)  $\frac{r_1}{r_2}$

(2)  $\left(\frac{r_1}{r_2}\right)^2$

(3)  $\frac{r_2}{r_1}$

(4)  $\left(\frac{r_2}{r_1}\right)^2$

**Sol.**

$$v_1 r_1 = v_2 r_2 \quad (\because \text{angular momentum is Constant})$$

**Answer (3)**

**Q.10.** A radioactive nucleus of mass  $M$  emits a photon of frequency  $\nu$  and the nucleus recoils. The recoil energy will be

(1)  $h\nu$

(2)  $Mc^2 - h\nu$

(3)  $\frac{h^2 \nu^2}{2Mc^2}$

(4) Zero

**Sol.**

$$E = \frac{(\text{momentum})^2}{2M} = \frac{\left(\frac{h\nu}{c}\right)^2}{2M}$$

**Answer (3)**

**Q. 11.** The potential energy of a system increases if work is done

(1) Upon the system by a conservative force





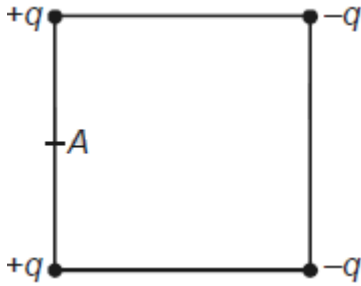

(1) Zero

(2)  $\frac{1}{4\pi\epsilon_0} \frac{2q}{L} (1 + \sqrt{5})$

(3)  $\frac{1}{4\pi\epsilon_0} \frac{2q}{L} (1 + \frac{1}{\sqrt{5}})$

(4)  $\frac{1}{4\pi\epsilon_0} \frac{2q}{L} (1 - \frac{1}{\sqrt{5}})$

**Sol.**

$$V = \frac{2Q}{4\pi\epsilon_0 L} - \frac{2Q}{4\pi\epsilon_0 L\sqrt{5}} = \frac{2Q}{4\pi\epsilon_0 L} \left[ 1 - \frac{1}{\sqrt{5}} \right] \text{ Volt}$$

**Answer : (4)**

**Q. 17.** A parallel plate condenser has a uniform electric field  $E$  (V/m) in the space between the plates. If the distance between the plates is  $d$  (m) and area of each plate is  $A(\text{m})^2$  the energy (joules) stored in the condenser is

(1)  $\frac{1}{2} \epsilon_0 E^2 Ad$

(2)  $\frac{E^2 Ad}{\epsilon_0}$

(3)  $\frac{1}{2} \epsilon_0 E^2$

(4)  $\epsilon_0 EAd$

**Sol.**

Direct formula: (energy density =  $\frac{1}{2} \epsilon_0 E^2$ )  $\times$  volume

**Answer : (1)**

**Q. 18.** If power dissipated in the 9 W resistor in the circuit shown is 36 Watt, the potential difference across the 2  $\Omega$  resistor is

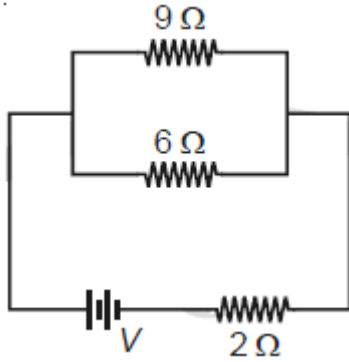

(1) 2 Volt

(2) 4 Volt

(3) 8 Volt

(4) 10 Volt

**Sol :**

Current in  $9\ \Omega$  is 2A, so that in  $6\ \Omega$  is 3A. Total current is  $2 + 3 = 5\text{A}$ . Potential drop =  $5 \times 2 = 10\text{V}$

**Answer: (4)**

**Q. 19.** A current of 2 A flows through a  $2\ \Omega$  resistor when connected across a battery. The same battery supplies a current of 0.5 A when connected across a  $9\ \Omega$  resistor. The internal resistance of the battery is

(1)  $1\ \Omega$

(2)  $0.5\ \Omega$

(3)  $1/3\ \Omega$

(4)  $1/4\ \Omega$

**Sol:**

$$2 = \frac{\varepsilon}{2+r}$$

$$0.5 = \frac{\varepsilon}{9+r}$$

$$\text{or } \frac{2}{0.5} = \frac{9+r}{2+r} \therefore r = \frac{1}{3}\ \Omega$$

**Answer: (3)**

**Q. 20.** The rate of increase of thermo e.m.f. with temperature at the neutral temperature of a thermocouple

(1) Is negative

(2) Is positive

(3) Is zero

(4) Depends upon the choice of the two materials of the thermocouple

**Sol :**

Slope is zero at neutral temperature.

**Answer: (3)**

**Q. 21.** A current carrying closed loop in the form of a right angle isosceles triangle ABC is placed in a uniform magnetic field acting along AB. If the magnetic force on the arm BC is  $\vec{F}$ , the force on the arm AC is

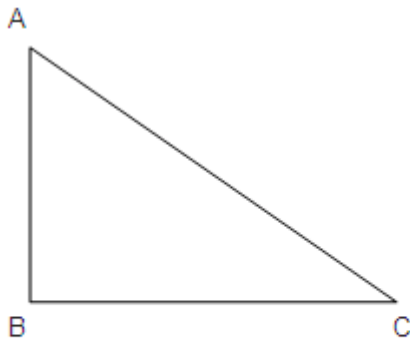

(1)  $\sqrt{2} \vec{F}$

(2)  $-\sqrt{2} \vec{F}$

(3)  $-\vec{F}$

(4)  $\vec{F}$

**Sol.**

$$\vec{F} = I \vec{L} \times \vec{B}$$

**Answer : (3)**

**Q.22.** The power obtained in a reactor using U235 disintegration is 1000 kW. The mass decay of U235 per hour is

(1) 1 microgram

(2) 10 microgram

(3) 20 microgram

(4) 40 microgram

**Sol.**



$$E = mc^2$$

$$1000 \times 10^3 \times 3600 = m (3 \times 10^8)^2$$

**Answer : (4)**

**Q. 23.** There are four light-weight-rod samples,  $A, B, C, D$  separately suspended by threads. A bar magnet is slowly brought near each sample and the following observations are noted

- (i)  $A$  is feebly repelled
- (ii)  $B$  is feebly attracted
- (iii)  $C$  is strongly attracted
- (iv)  $D$  remains unaffected

Which one of the following is true?

- (1)  $A$  is of a non-magnetic material
- (2)  $B$  is of a paramagnetic material
- (3)  $C$  is of a diamagnetic material
- (4)  $D$  is of a ferromagnetic material

**Sol.**

Diamagnetic will be feebly repelled. Paramagnetic will be feebly attracted. Ferromagnetic will be strongly attracted.

**Answer : (2)**

**Q. 24.** The electric and the magnetic field, associated with an e.m. wave, propagating along the  $+z$ -axis, can be represented by

- (1)  $[\vec{E} = E_0 \hat{j}, \vec{B} = B_0 \hat{k}]$
- (2)  $[\vec{E} = E_0 \hat{i}, \vec{B} = B_0 \hat{j}]$
- (3)  $[\vec{E} = E_0 \hat{k}, \vec{B} = B_0 \hat{i}]$
- (4)  $[\vec{E} = E_0 \hat{j}, \vec{B} = B_0 \hat{i}]$

**Sol.**

$\vec{E} \times \vec{B}$  Points in the direction of wave propagation.

**Answer : (2)**

**Q. 25.** A uniform electric field and a uniform magnetic field are acting along the same direction in certain region. If an electron is projected in the region such that its velocity is pointed along direction of fields, then the electron

- (1) Will turn towards left of direction of motion
- (2) Will turn towards right of direction of motion
- (3) Speed will decrease
- (4) Speed will increase

**Sol.**

Bfield will not apply any force.  $E$  field will apply a force opposite to velocity of the electron hence, speed will decrease.

**Answer : (3)**

**Q. 26.** The current  $i$  in a coil varies with time as shown in the figure. The variation of induced emf with time would be

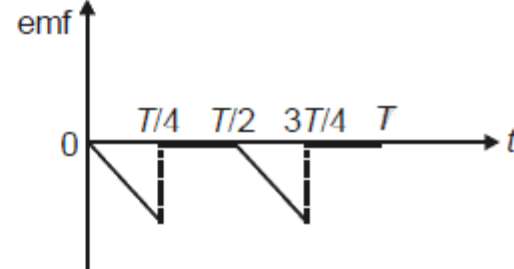
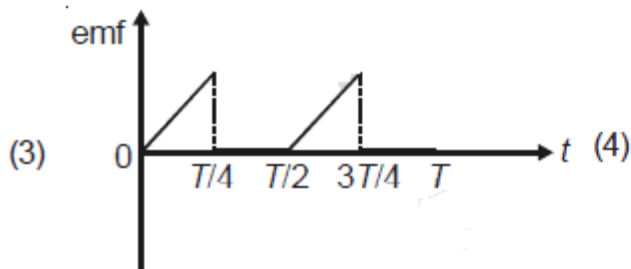
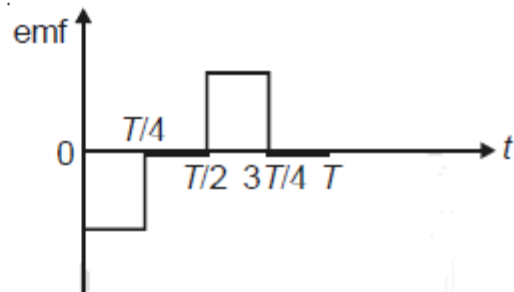
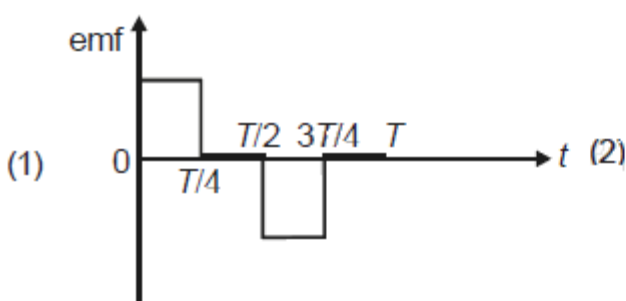
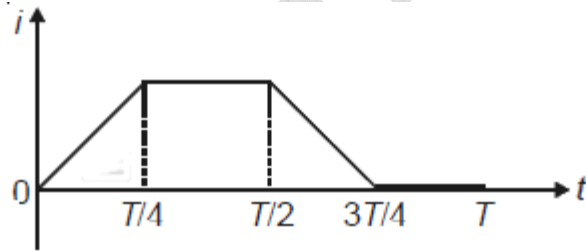

**Sol.**

$$E \propto -\frac{di}{dt}$$

**Answer : (2)**

**Q.27.** In an ac circuit an alternating voltage  $e = 200 \sqrt{2} \sin 100t$  volts is connected to capacitor of capacity  $1 \mu\text{F}$ . The r.m.s. value of the current in the circuit is

(1) 20 mA

(2) 10 mA

(3) 100 mA

(4) 200 mA

**Sol.**

$$I_{\text{RMS}} = \frac{\frac{e_0}{\sqrt{2}}}{\omega C} = 200 \times 100 \times 10^{-6} \text{ A}$$

**Answer : (1)**

**Q. 28.** An ac voltage is applied to a resistance  $R$  and inductor  $L$  in series. If  $R$  and the inductive reactance are both equal to  $3 \Omega$ , the phase difference between the applied voltage and the current in the circuit is

(1) Zero

(2)  $\pi/6$

(3)  $\pi/4$

(4)  $\pi/2$

**Sol.**

$$\tan \theta = \frac{X_L}{R} = 1 \therefore \phi = 45^\circ \text{ or } \pi/4$$

**Answer : (3)**

**Q. 29.** When 1 kg of ice at  $0^\circ\text{C}$  melts to water at  $0^\circ\text{C}$ , the resulting change in its entropy, taking latent heat of ice to be  $80 \text{ cal}/^\circ\text{C}$  is

(1) 293 cal/K

(2) 273 cal/K

(3)  $8 \times 10^4$  cal/K

(4) 80 cal/K

**Sol:**

$$\Delta S = \frac{\Delta Q}{T} = \frac{80 \times 1000}{273} \approx 293 \text{ cal/K}$$

**Answer : (1)**

**Q. 30.** During an isothermal expansion, a confined ideal gas does  $-150$  J of work against its surrounding. This implies that

(1) 150 J of heat has been added to the gas

(2) 150 J of heat has been removed from the gas

(3) 300 J of heat has been added to the gas

(4) No heat is transferred because the process is isothermal

**Sol:**

$$\Delta Q = \Delta U + \Delta W$$

$$\Delta Q = 0 - 150 \text{ J}$$

So, heat has been given by the system

**Answer : (2)**

**Q. 31.** A particle of mass  $m$  is released from rest and follows a parabolic path as shown. Assuming that the displacement of the mass from the origin is small, which graph correctly depicts the position of the particle as a function of time?



**Q. 33.** Out of the following functions representing motion of a particle which represents SHM?

(A)  $y = \sin \omega t - \cos \omega t$

(B)  $y = \sin^3 \omega t$

(C)  $y = 5 \cos \left( \frac{3\pi}{4} - 3\omega t \right)$

(D)  $y = 1 + \omega t + \omega^2 t^2$

(1) Only (A) and (B)

(2) Only (A)

(3) Only (D) does not represent SHM

(4) Only (A) and (C)

**Sol.**

For SHM,  $\frac{d^2 y}{dt^2} \propto -y$

**Answer : (4)**

**Q. 34.** Sound waves travel at 350 m/s through a warm air and at 3500 m/s through brass. The wavelength of a 700 Hz acoustic wave as it enters brass from warm air

(1) Decreases by a factor 20

(2) Decreases by a factor 10

(3) Increases by a factor 20

(4) Increases by a factor 10

**Sol.**

$\therefore$  frequency is same in both the medium

$\therefore \lambda \propto \text{speed}$

**Answer : (4)**

**Q. 35.** The decreasing order of wavelength of infrared, microwave, ultraviolet and gamma rays is

(1) Infrared, microwave, ultraviolet, gamma rays

(2) Microwave, infrared, ultraviolet, gamma rays

(3) Gamma rays, ultraviolet, infrared, microwaves

(4) Microwaves, gamma rays, infrared, ultraviolet

**Sol.**

Fact based question

**Answer : (2)**

**Q. 36.** The wavelength of the first line of Lyman series for hydrogen atom is equal to that of the second line of Balmer series for a hydrogen like ion. The atomic number  $Z$  of hydrogen like ion is

(1) 2

(2) 3

(3) 4

(4) 1

**Sol.**

$$\left(1 - \frac{1}{4}\right) = Z^2 \left[\frac{1}{4} - \frac{1}{16}\right]$$
$$\therefore Z = 2$$

**Answer : (1)**

**Q.37.** Which of the following is not due to total internal reflection?

(1) Brilliance of diamond

(2) Working of optical fibre

(3) Difference between apparent and real depth of a pond

(4) Mirage on hot summer days

**Sol.**

Real & apparent depth are explained on the basis of refraction only. TIR not involved here.

**Answer : (3)**

**Q. 38.** A biconvex lens has a radius of curvature of magnitude 20 cm. Which one of the following options describe best the image formed of an object of height 2 cm placed 30 cm from the lens?

- (1) Real, inverted, height = 1 cm                      (2) Virtual, upright, height = 1 cm  
(3) Virtual, upright, height = 0.5 cm                      (4) Real, inverted, height = 4 cm

**Sol.**

In general we have assumed  $\mu = 1.5$ ,

So,  $f = 20$  cm and calculate  $v = 60$  cm

$$\text{So, magnification is } \frac{v}{u} = -2$$
$$\frac{|h_i|}{|h_o|} = 2, |h_i| = 2|h_o|$$

**Answer : (4)**

**Q. 39.** In photoelectric emission process from a metal of work function 1.8 eV, the kinetic energy of most energetic electrons is 0.5 eV. The corresponding stopping potential is

- (1) 2.3 V                      (2) 1.8 V  
(3) 1.3 V                      (4) 0.5 V

**Sol.**

$$eV = KE_{\max}$$

**Answer : (4)**

**Q. 40.** Electrons used in an electron microscope are accelerated by a voltage of 25 kV. If the voltage is increased to 100 kV then the de-Broglie wavelength associated with the electrons would

- (1) Increase by 4 times                      (2) Increase by 2 times  
(3) Decrease by 2 times                      (4) Decrease by 4 times





(1) 100 years

(2) 150 years

(3) 200 years

(4) 250 years

**Sol:**

After t second fractional amount of X left is  $\frac{1}{16}$  or  $(\frac{1}{2})^4$ ,

$$t = 4 \times T_{1/2}$$

$$t = 4 \times 50$$

$$= 200 \text{ years}$$

**Answer : (3)**

**Q. 44.** Photoelectric emission occurs only when the incident light has more than a certain minimum

(1) Frequency

(2) Power

(3) Wavelength

(4) Intensity

**Sol:**

Concept of threshold frequency

**Answer : (1)**

**Q. 45.** Fusion reaction takes place at high temperature because

(1) Molecules break up at high temperature

(2) Nuclei break up at high temperature

(3) Atoms get ionised at high temperature

(4) Kinetic energy is high enough to overcome the coulomb repulsion between nuclei

**Sol:**

Fact

**Answer : (4)**

**Q. 46.** A nucleus  ${}^m_nX$  emits one  $\alpha$  particle and two  $\beta$ -particles. The resulting nucleus is

(1)  ${}^{m-4}_{n-2}Y$

(2)  ${}^{m-6}_{n-4}Z$

(3)  ${}^{m-6}_nZ$

(4)  ${}^{m-4}_nX$

**Sol:**

$\alpha$  emission decreases mass number by 4 and atomic number by 2. One  $\beta$ - emission increases atomic number by one but leaves mass number unchanged.

**Answer : (4)**

**Q.47.** A transistor is operated in common emitter configuration at  $V_C = 2$  V such that a change in the base current from 100  $\mu$ A to 300  $\mu$ A produces a change in the collector current from 10 mA to 20 mA. The current gain is

(1) 25

(2) 50

(3) 75

(4) 100

**Sol:**

$$\text{Current gain } \beta = \frac{(20 - 10) \times 10^{-3}}{(300 - 100) \times 10^{-6}} = 50$$

**Answer : (2)**

**Q.48.** If a small amount of antimony is added to germanium crystal

(1) Its resistance is increased

(2) It becomes a p-type semiconductor

(3) The antimony becomes an acceptor atom

(4) There will be more free electrons than hole in the semiconductor

**Sol:**

Addition of antimony will make it an N-type semiconductor

**Answer : (4)**

**Q.49.** In forward biasing of the p-n junction

- (1) The positive terminal of the battery is connected to p-side and the depletion region becomes thin
- (2) The positive terminal of the battery is connected to p-side and the depletion region becomes thick
- (3) The positive terminal of the battery is connected to n-side and the depletion region becomes thin
- (4) The positive terminal of the battery is connected to n-side and the depletion region becomes thick

**Sol:**

Fact

**Answer : (1)**

**Q.50.** Symbolic representation of four logic gates are shown as

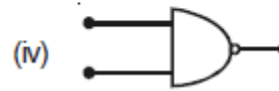
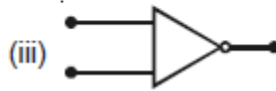

Pick out which ones are for AND, NAND and NOT gates, respectively :

- (1) (ii), (iv) and (iii)
- (2) (ii), (iii) and (iv)
- (3) (iii), (ii) and (i)
- (4) (iii), (ii) and (iv)

**Sol:**

Fact

**Answer : (1)**

*indiapmt.com*