

## REASONING

1. Which of the following will come in the place of the question mark (?) in the following series based on the English alphabetical order?

AEC BFD CGE DHF ?

- (1) EJG (2) EIH  
(3) FIG (4) EIG  
(5) EGI

2. In a certain code language, 'PLATE' is coded as 'QMBUF' and 'CLOUD' is coded as 'DMPVE'. In the same code language, 'RIGHT' will be coded as \_\_\_\_\_.

- (1) SHIU (2) SJHIU  
(3) IUHSJ (4) SJGIU  
(5) None of these

3. How many meaningful English words can be formed with the letters 'ALFT' using all the letters, but, each letter only once in each word?

- (1) One (2) Two  
(3) Three  
(4) More than three  
(5) None

4. Which of the following will come next in the following series?

9 8 7 6 5 4 3 2 1 0 9 8 7 6 5 4 3  
2 1 9 8 7 6 5 4 3 2 9 8 7 6 5 4 3

- (1) 9 (2) 2  
(3) 1 (4) 4  
(5) 8

5. Twelve students are standing in straight line facing North. S is tenth from the left end. T is sixth from the right end. There are five students between S and U. How many students are standing between T and U?

- (1) Four (2) Ten  
(3) Eight (4) Five  
(5) Two

6. A is the son of H. B is the sister of A. C is the uncle of B. How is H related to C?

- (1) Brother-in-law  
(2) Sister (3) Brother  
(4) Sister-in-law  
(5) Cannot be determined

7. 'Gold' is related to 'Metal' in the same way as 'Water' is related to \_\_\_\_\_.

- (1) Hydrogen (2) Liquid  
(3) Thirst (4) Oxygen  
(5) Fire

8. If each letter in the word 'SCALED' is changed to the next letter in the English alphabetical series and then the alphabets so formed are arranged in an alphabetical order from **left to right**, which of the following will be fourth from the left?

- (1) B (2) E  
(3) M (4) F  
(5) D

9. Four of the following five are alike in a certain way and hence form a group. Which of the following does not belong to that group?

- (1) Rupee (2) Dollar  
(3) Currency (4) Yen  
(5) Dinar

10. How many such pairs of letters are there in the word 'WANDERER', each of which has as many letters between them in the word (in both forward and backward directions) as they have between them in the English alphabetical series?

- (1) None (2) Three  
(3) Two (4) One  
(5) More than three

**Directions (11-15):** Study the following information and answer the questions given below:

Eight people P, Q, R, S, T, U, V and W are sitting around a circular table facing the centre, but not necessarily in the same order. Q is second to the left of T. V is third to the right of T. W is second to the right of R. R is not an immediate neighbour of either Q or T. U is not an immediate neighbour of W. P is second to the right of U.

11. How many people are sitting between P and W, when counted in a clockwise direction, starting from W?

- (1) Three (2) One  
(3) None (4) Two  
(5) More than three

12. Which of the following will come in the place of the question mark (?) in the following series based on the seating arrangement given?

TP RW SQ UP ?

- (1) RW (2) RV  
(3) VR (4) VS  
(5) VW

13. What is the position of R with respect to S?

- (1) Third to the right  
(2) Third to the left  
(3) Fourth to the right  
(4) Fourth to the left  
(5) Second to the left

14. If all the persons are asked to sit in an alphabetical order in a **clockwise** direction starting from P, the positions of how many will remain unchanged, excluding P?

- (1) None (2) Three  
(3) Two  
(4) More than three

(5) One

15. Who amongst the following is sitting exactly between S and U?

- (1) W (2) T  
(3) Q (4) V  
(5) P

**Directions (16-20) :** Study the following information and answer the questions given below :

Seven people A, B, C, D, E, F and G are standing in a straight line facing North, not necessarily in the same order. F is standing third to the right of B. G is standing second to the right of F. C is standing third to the left of G. E is standing fourth to the right of C. A is not an immediate neighbour of B.

**16.** If all the people are asked to stand in an alphabetical order from left to right, the positions of how many will remain unchanged ?

- (1) Three      (2) Two  
(3) None      (4) One  
(5) More than three

**17.** Who is standing second to the right of B ?

- (1) C            (2) G  
(3) D            (4) E  
(5) None of these

**18.** Which of the following pairs represents the people standing at the extreme ends of the line ?

- (1) GD            (2) BG  
(3) BE            (4) ED  
(5) AB

**19.** How many people are standing between E and A ?

- (1) One          (2) Two  
(3) Three  
(4) More than three  
(5) None

**20.** What is the position of F with respect to D ?

- (1) Immediate right  
(2) Third to the left  
(3) Second to the left  
(4) Third to the right  
(5) Second to the right

**Directions (21-25) :** In each of the questions below, two statements are given followed by two conclusions numbered I and II. You have to take the two statements to be true even if they seem to be at variance from the commonly known facts and then decide which of the given conclusions logically follows from the given statements disregarding the commonly known facts.

**Give answer (1)** if **only** conclusion I follows

**Give answer (2)** if **only** conclusion II follows

**Give answer (3)** if **either** conclusion I or II follows

**Give answer (4)** if **neither** conclusion I nor II follows

**Give answer (5)** if **both** conclusions I and II follow

**21. Statements :**

Some colours are paints.

Some colours are crayons.

**Conclusions :**

I. All crayons are paints.

II. Atleast some paints are colours.

**22. Statements :**

All villages are districts.

Some districts are countries.

**Conclusions :**

I. Atleast some countries are districts

II. Atleast some districts are villages

**23. Statements :**

All trucks are vans.

All vans are vehicles.

**Conclusions :**

I. All vehicles are vans.

II. All trucks are vehicles.

**24. Statements :**

No rice is wheat.

All grains are wheat.

**Conclusions :**

I. No rice is a grain.

II. All wheat are grains.

**25. Statements :**

Some dogs are cats.

No cat is a mouse.

**Conclusions :**

I. No mouse is a dog.

II. All cats are dogs.

**Directions (26-30) :** Following questions are based on the five three letter words given below :

NIT CUB PAN LEG MOP

**(Note :** The words formed after performing the given operations may or may not be meaningful English words)

**26.** If the positions of the first and third letters of all of the words are interchanged and then the words thus formed are ar-

ranged alphabetically from left to right, which of the following will be third from the left ?

- (1) MOP          (2) LEG  
(3) PAN          (4) CUB  
(5) NIT

**27.** If the positions of the first and second letters of all the words are interchanged, how many words will form meaningful English words ?

- (1) One          (2) Three  
(3) None        (4) Two  
(5) More than three

**28.** If all the letters in each of the words are arranged alphabetically (within the word), how many words will remain unchanged ?

- (1) Two          (2) Three  
(3) None        (4) One  
(5) More than three

**29.** If the first letter of all the words is changed to the next letter of the English alphabetical series, how many words will have more than one vowel ? (Same or different vowel)

- (1) One          (2) Two  
(3) Three  
(4) More than three  
(5) None

**30.** According to the English alphabetical series, how many letters are there between the first letter of the fourth word from the left and the second letter of the fifth word from the left ?

- (1) Three        (2) None  
(3) One          (4) Four  
(5) Two

**Directions (31-35) :** Study the following arrangement carefully and answer the questions given below:

XKYHRUF CVGZOTQ  
PSW MEDNILJAB

**31.** How many meaningful English words can be formed with the fifth letter from the left end, thirteenth letter from the left end and the second letter from the right end, using all the letters but each letter only once in each word ?

- (1) One (2) Two  
 (3) Three (4) None  
 (5) More than three

32. Four of the following five are similar in a certain way based on their positions in the above arrangement and hence form a group. Which of the following does not belong to the group?

- (1) KUH (2) ZPT  
 (3) IBJ (4) PDW  
 (5) GGO

33. If in a certain code 'HUNT' is coded as 'RFIQ' and 'PLOT' is coded as 'SJTQ', then how will 'FADS' be coded in the same code?

- (1) CJNW (2) UBNW  
 (3) CBEW (4) CBWN  
 (5) CBNW

34. What will come in place of the question mark (?) in the following series based upon the above arrangement?

- BA JL ND WS ?  
 (1) TO (2) ZG  
 (3) OZ (4) OG  
 (5) TZ

35. Which of the following is seventh to the right of the seventeenth from the right end of the above arrangement?

- (1) W (2) M  
 (3) S (4) G  
 (5) E

**Directions (36-40) :** In these questions, relationships between different elements is shown in the statements. These statements are followed by two conclusions.

**Give answer (1) if only conclusion I follows**

**Give answer (2) if only conclusion II follows**

**Give answer (3) if either conclusion I or conclusion II follows**

**Give answer (4) if neither conclusion I nor conclusion II follows**

**Give answer (5) if both conclusions I and II follow**

36. **Statement :**

$$F > G \geq H < I > J$$

**Conclusions :**

- I.  $F \geq I$   
 II.  $G < J$

37. **Statement :**

$$K > L \geq M = N < O$$

**Conclusions :**

- I.  $K < O$   
 II.  $N \leq L$

38. **Statement :**

$$A > B = C > D < E$$

**Conclusions :**

- I.  $E > B$   
 II.  $A > D$

39. **Statement :**

$$U < V = W \leq X = Y < Z$$

**Conclusions :**

- I.  $Z > U$   
 II.  $V \leq Y$

40. **Statement :**

$$P > Q < R = S \leq T$$

**Conclusions :**

- I.  $Q < T$   
 II.  $P \leq T$

**Directions (41-45) :** In each question below is given a group of numbers and symbols followed by five combinations of alphabet codes numbered (1), (2), (3), (4) and (5). You have to find out which one of the combinations correctly represents the group of numbers and symbols based on the following coding system and the conditions. Mark the number of the correct combination as your answer.

Number/ Symbol	8	3	5	4	@	#	%	+	2	6	7	&	9
Alphabet Codes	L	D	U	C	Z	H	Y	R	T	F	G	S	W

**Conditions :**

- I. If the third element is an even number and the last element is an odd number, then the even number is to be coded as the code for that odd number.  
 II. If the first element is a symbol and last element is an odd number then the codes for both these elements have to be interchanged.  
 III. If there are no symbols in the group of elements then the second element is to be coded as 'A'.

41. 5&%82+

- (1) USRLTY (2) USYLTR  
 (3) YSULTR (4) USYTLR  
 (5) USYLFR

42. %73@29

- (1) YGDZTW (2) WDGZTY  
 (3) WGDZTY (4) WGDZTW  
 (5) WGDZFY

43. 8@4#37

- (1) LZGHDG (2) LZCHDC  
 (3) LZCHDG (4) LZGHDC  
 (5) TZGHDG

44. 429563

- (1) CTWUFD (2) CAUWFD  
 (3) CTWUDF (4) CAWUFD  
 (5) CADUFW

45. 6#8+59

- (1) FHLRUW (2) FHLRUL  
 (3) FHWRUW  
 (4) FHWRUL  
 (5) FHWURW

**Directions (46-50) :** Study the following information and answer the questions given below :

Seven movies A, B, C, D, E, F and G are scheduled to be screened on seven different days of the same week, not necessarily in the same order. The week starts from Monday and ends on Sunday.

Only two movies will be screened before E. Three movies will be screened between E and F. Four movies will be screened between C and D. A will be screened immediately after C. B will not be screened immediately before D.

46. Movie C will be screened on which of the following days?

- (1) Tuesday (2) Sunday  
 (3) Saturday (4) Wednesday  
 (5) Monday

47. Which movie(s) will be screened between G and F?

- (1) Both B and E  
 (2) Only D  
 (3) Only E  
 (4) Both E and D  
 (5) None of these

48. Which of the following statements is true regarding the given schedule?

- (1) E will be screened immediately before B  
 (2) D will be screened on Friday  
 (3) One movie will be screened between A and E

- (4) Only one movie will be screened after F  
 (5) None is true
49. How many movies will be screened between E and Q?  
 (1) Three (2) One  
 (3) None (4) Two  
 (5) More than three
50. Which movie will be screened on Friday?  
 (1) C (2) B  
 (3) D (4) F  
 (5) None of these

## ENGLISH LANGUAGE

**Directions (51-60) :** In the following passage there are blanks, each of which has been numbered. These numbers are printed below the passage, against each, five words are suggested, one of which fits the blank appropriately. Find out the appropriate word in each case.

One day a king stepped (51) of the gates of his palace and found a man standing (52). The man had a plump chicken in his hands. On seeing the king he bowed respectfully and said, "Maharaj, I gambled and won this chicken. I had promised everyone in the village that if I won, I would (53) my prize to you. Please (54) it." The king was very (55) of gifts. So he willingly accepted the chicken. "Give it to my poultry keeper," said the king. A few days later the king saw the same man standing outside the gates again. This time he had a goat with him. "I won this goat while gambling. I had promised my wife that if I won I would present my prize to you," he said after saluting the ruler. "It belongs to you." The king was pleased again. "Give it to my goat keeper," he said.

Some weeks (56) the man was at the palace gates once again. This time he had two men with him. "I (57) five hundred gold coins while gambling and owe them to these men, Maharaj," said the man. "I had promised them that whatever I won, I would present it to you. I have no money to (58) them." The king realised he had made a mistake by accepting the man's gifts on the (59)

occasions. Now he could not refuse to help him. He paid the money to the two men and (60) the man to never gamble again.

51. (1) by (2) before  
 (3) in (4) out  
 (5) on
52. (1) there (2) near  
 (3) away (4) here  
 (5) where
53. (1) steal (2) throw  
 (3) borrow (4) gave  
 (5) present
54. (1) took (2) accept  
 (3) give (4) expect  
 (5) except
55. (1) fond (2) full  
 (3) penchant (4) crazy  
 (5) liking
56. (1) hence (2) soon  
 (3) later (4) after  
 (5) before
57. (1) take (2) misplace  
 (3) counted (4) lost  
 (5) win
58. (1) owe (2) pay  
 (3) repaid (4) gave  
 (5) lend
59. (1) upcoming (2) gone  
 (3) previous (4) final  
 (5) next
60. (1) request (2) order  
 (3) threaten (4) ask  
 (5) warned

**Directions (61-65) :** Each sentence below has a blank, each blank indicating that something has been omitted. Choose the word that best fits the meaning of the sentence as a whole.

61. The e-mail was \_\_\_\_\_ to all the teachers.  
 (1) address (2) gave  
 (3) sent (4) show  
 (5) attached
62. Why \_\_\_\_\_ you not replied yet?  
 (1) have (2) has  
 (3) are (4) can't  
 (5) could
63. Her watch was not only expensive but \_\_\_\_\_ attractive.  
 (1) and (2) again  
 (3) not (4) also  
 (5) that

64. Hamid was very \_\_\_\_\_ to announce the results.  
 (1) happily (2) eager  
 (3) free (4) fast  
 (5) quickly
65. Rochelle and Dena are \_\_\_\_\_ to visit India.  
 (1) planning (2) gone  
 (3) seeing (4) wait  
 (5) cancelled

**Directions (66-75) :** Read each sentence to find out whether there is any grammatical error or idiomatic error in it. The error, if any, will be in one part of the sentence. The number of that part is the answer. If there is no error the answer is '5'. (Ignore errors of punctuation if any.)

66. All the employees (1)/ have agreed to (2)/ contribute in some (3)/ way or the other. (4)/ No Error (5)
67. The thief could not (1)/ get away along Meena's (2)/ wallet as the bus (3)/ was very crowded. (4)/ No Error (5)
68. They had decided (1)/ to renovate the (2)/ house before (3)/ the monsoon start. (4)/ No Error (5)
69. Everyone in the (1)/ class teased (2)/ Manoj about his (3)/ poor pronunciation. (4)/ No Error (5)
70. Both the candidates (1)/ were ask to (2)/ submit their documents (3)/ at the bank. (4)/ No Error (5)
71. The king sought (1)/ his minister's advice on (2)/ the dispute between (3)/ the two party. (4)/ No Error (5)
72. All the villagers (1)/ respected to the judge (2)/ as he was a very (3)/ wise and noble man. (4)/ No Error (5)
73. Shweta was very happy (1)/ because she had scored (2)/ the most highest marks (3)/ in her class. (4)/ No Error (5)
74. The accused was (1)/ given a chance (2)/ for defend himself but (3)/ he refused to talk. (4)/ No Error (5)
75. The child were (1)/ excited about their (2)/ trip to (3)/ the amusement park. (4)/ No Error (5)

**Directions (76-80) :** In each question below, four words printed in **bold** type are given. These are numbered (1), (2), (3) and (4). One of these words printed in **bold** may either be **wrongly spelt or inappropriate** in the context of the sentence. Find out the word that is inappropriate or wrongly spelt, if any. The number of that word is your answer. If all the words printed in bold are correctly spelt and appropriate in the context of the sentence then mark (5) i.e. 'All Correct' as your answer.

76. He wanted to **cell** (1)/ his **house** (2)/ and buy **another** (3)/ one in the same **locality**. (4)/ All correct (5)
77. Somesh's **teacher** (1)/ **complained** (2)/ about his **annoying** (3)/ **behaviour**. (4)/ All correct (5)
78. No one **believed** (1)/ her **excuses** (2)/ for not **attending** (3)/ the **meting**. (4)/ All correct (5)
79. How can you **identify** (1)/ the **culprit** (2)/ without **questioning** (3)/ **anyone**. (4)/ All correct (5)
80. All his **money** (1)/ was **stolen** (2)/ before he **reacched** (3)/ the **bank**. (4)/ All correct (5)

**Directions (81-85) :** Rearrange the following six sentences (A), (B), (C), (D), (E) and (F) in proper sequence to form a meaningful paragraph then answer the questions given below them.

- (A) The intelligent minister thought about his task, after a few hours, went out and returned with a beggar and said to the emperor, "He is the poorest among your subjects your majesty."
- (B) "He has been given the honour of an audience with the emperor," said the minister, "That makes him the noblest among beggars."
- (C) "It is possible," said the minister.
- (D) An emperor asked his most intelligent minister, if it was possible for a man to be the poorest and the noblest at the same time.

(E) "Then bring me such a person," said the emperor.

(F) "That might be true," said the emperor, "But I don't see how he can be the noblest."

81. Which of the following should be the **second** sentence in the rearrangement ?

- (1) A (2) C  
(3) F (4) D  
(5) E

82. Which of the following should be the **first** sentence in the rearrangement ?

- (1) F (2) A  
(3) C (4) D  
(5) B

83. Which of the following should be the **fifth** sentence in the rearrangement ?

- (1) F (2) C  
(3) E (4) A  
(5) D

84. Which of the following should be the **last (sixth)** sentence in the rearrangement ?

- (1) A (2) C  
(3) B (4) D  
(5) F

85. Which of the following should be the **fourth** sentence in the rearrangement ?

- (1) F (2) E  
(3) A (4) C  
(5) D

**Directions (86-100) :** Read the following passage carefully and answer the questions given below it. Certain words/phrases have been printed in **bold** to help you locate them while answering some of the questions.

There lived a wolf called Lulu In the Himalayan forests. Lulu was very mean and **selfish**. He thought only about himself and none of the other animals liked him. The rest of the wolf pack also avoided meeting him. At most, they would say a polite 'Hello' and then would go their own way. After all, when they were hungry, Lulu never offered to share his meal. Once while wandering around, Lulu saw an elephant trapped in a hunter's trap. The elephant requested Lulu to help but

he simply **mocked** the elephant and continued on his way. Later one of the other wolves helped the elephant in escaping from the trap.

One day, Lulu was very hungry and went out hunting. After searching around for nearly an hour, he found a few roosters. The moment they saw Lulu, they tried to run away but he managed to catch one of them. The others begged him to leave their friend but Lulu scared them away. When the other wolves saw him eating a rooster, they knew that he would never share his meal so they ignored him. Lulu greedily swallowed the rooster. Suddenly, a small bone got stuck in his throat. Lulu kept coughing and tried to get the bone out of his throat, but in vain. He ran up and down groaning and moaning, seeking something to relieve his pain.

He requested the other roosters to help him but they said, "When we requested you to leave us alone you scared us away. How can you expect us to help you ?" Then Lulu requested the other wolves to help him but they said, "Had you been generous and shared your meals with us, we would have helped you. "Next he went to the elephant. The elephant said, "When I asked you to help me, you did not. Why should I help you now ?"

After some time, it started becoming difficult for him to breathe. He pleaded with all the other animals to help him get the bone out. "Please help! Someone please help me get this bone out" appealed Lulu. But no one stepped forward. He even offered them a **reward** for removing the bone. "Oh Please! I can't breathe. I would give anything if you help me take it out," he said. But no one helped him — because he was so mean to everyone. Then at last a crane, Rani, took pity on him and offered to help him. Rani told Lulu to lie on his side and open his jaws as wide as he could. She put her long neck down his throat and used her beak to remove the bone. "That's better" said Lulu, taking long deep breaths. Rani then said, "Lulu, I do not want any reward from you but I

just want you to promise me that you will become a better wolf and start sharing things with the other animals. You should be more considerate and kind towards the others in the forest." Lalu grinned wide, showing all his teeth. He said, "**Be content** Rani. You have just put your head inside a wolf's mouth and taken it out again safely; that ought to be a reward for you. Do not expect anything else from me."

Poor Rani was very disappointed. The other animals looked at Lalu angrily. But neither did Lalu **comprehend** nor care.

**86.** What did the roosters do when they saw Lalu ?

- (1) They ignored him and stayed where they were
- (2) They asked him to join them
- (3) They tried to scare him away
- (4) They ran and tried to escape
- (5) They put a bone in his throat

**87.** How did the other wolves treat Lalu ?

- (1) They were friendly with him
- (2) They played tricks on him
- (3) They followed him
- (4) They always helped him
- (5) They tried to avoid him

**88.** What did Lalu do when he saw an elephant trapped in a hunter's trap ?

- (1) He mocked the elephant and went ahead
- (2) He stopped there and helped the elephant
- (3) He waited there till the hunter arrived
- (4) He killed the elephant
- (5) He killed the hunter

**89.** Why did Lalu start coughing?

- (1) He was unwell
- (2) He wanted to attract everyone's attention towards himself
- (3) He did not like the taste of the rooster he had just eaten
- (4) He had grown old and felt out of breath

(5) He was trying to remove the bone that was stuck in his throat

**90.** Which of the following is true according to the given passage ?

- (1) Lalu was kind
- (2) Lalu had eaten a hen
- (3) Lalu had deceived Rani
- (4) Lalu was everyone's favourite
- (5) All the animals helped Lalu

**91.** How did Rani help Lalu ?

- (1) She used her long neck and beak to remove the bone
- (2) She patted his back until he coughed out the bone
- (3) She requested the other animals to help him
- (4) She gave him water to swallow the bone
- (5) She used her feet to remove the bone

**92.** Why did the other wolves not help Lalu ?

- (1) Lalu had never shared his meal with them
- (2) Lalu had not helped them when they were trapped
- (3) Lalu used to threaten them
- (4) Lalu was very impolite while asking for their help
- (5) Lalu had eaten one of their pack members

**93.** What did Rani ask Lalu to do in exchange for her favour ?

- (1) She asked him to stop eating roosters
- (2) She asked him to be careful while eating
- (3) She asked him to apologise to the elephant
- (4) She asked him to become a better wolf
- (5) She asked him to provide her with a lot of food

**94.** What did Lalu do after Rani helped him remove the bone?

- (1) He thanked her and changed his ways
- (2) He went ahead and ate another rooster
- (3) He ate her up

(4) He asked her to be content that he had not eaten her head

(5) He did exactly what she had asked him to do

**95.** Why did the other wolves not talk to Lalu when they saw him eating a rooster ?

- (1) They did not want to disturb him while he was eating
- (2) They already knew that he would never share his meal with them
- (3) They did not want the other roosters to feel upset
- (4) They knew Lalu would offer to share his meal but they had already eaten
- (5) They felt that one rooster would never be enough for the whole pack

**Directions (96-98) :** Choose the word which is **most similar** in the meaning to the word printed in **bold** as used in the passage.

**96. Reward**

- (1) Money
- (2) Punishment
- (3) Reply
- (4) Salary
- (5) Prize

**97. Comprehend**

- (1) Speak
- (2) Understand
- (3) Handle
- (4) Recognise
- (5) Forget

**98. Mocked**

- (1) Faked
- (2) Pretended
- (3) Teased
- (4) Begged
- (5) Helped

**Directions (99-100) :** Choose the word which is **most opposite** in meaning to the word printed in **bold** as used in the passage.

**99. Selfish**

- (1) Intelligent
- (2) Generous
- (3) Lazy
- (4) Foolish
- (5) Cunning

**100. Content**

- (1) Satisfied
- (2) Material
- (3) Comfortable
- (4) Dislike
- (5) Unhappy

**NUMERICAL ABILITY**

**Directions (101-125) :** What should come in place of the question mark (?) in the following questions ?

101.  $\sqrt[3]{2197} = ?$

- (1) 17           (2) 9  
(3) 11           (4) 14  
(5) None of these

102.  $2451 + 7983 - 3451 = ?$

- (1) 6862       (2) 6833  
(3) 6675       (4) 6983  
(5) None of these

103.  $\frac{140}{28} \times \frac{234}{338} \times 13 = ?$

- (1) 45           (2) 78  
(3) 52           (4) 39  
(5) None of these

104.  $4370 \div 19 = (10)^2 + ?$

- (1) 230       (2) 270  
(3) 170       (4) 130  
(5) None of these

105.  $1.8 \times 3.2 \div ? = 2.88$

- (1) 4           (2) 5  
(3) 3           (4) 7  
(5) None of these

106.  $(17 \times 3 + 9) \div 3 = 5 \times (?)^2$

- (1)  $\pm 2$        (2)  $\pm 4$   
(3)  $\pm 3$        (4)  $\pm 9$   
(5) None of these

107.  $? \times 25 + 225 = 550$

- (1) 19       (2) 17  
(3) 15       (4) 13  
(5) None of these

108.  $6.8 \div 4 \times ? + 2.51 = 2.85$

- (1) 0.5       (2) 0.2  
(3) 0.9       (4) 0.6  
(5) None of these

109.  $540 \div 18 \times 30 \div ? = 60$

- (1) 25       (2) 17  
(3) 20       (4) 13  
(5) None of these

110.  $5.28\% \text{ of } ? = 491.04$

- (1) 9400       (2) 9900  
(3) 9300       (4) 9600  
(5) None of these

111.  $6.13 \times 2.8 \div 0.7 = ?$

- (1) 25.24       (2) 24.52  
(3) 25.42       (4) 22.54  
(5) None of these

112.  $19.21 + 12.91 + 91.12 + 29.11 = ?$

- (1) 135.35  
(2) 155.35       (3) 125.35  
(4) 152.35  
(5) None of these

113.  $3180 - 2450 + 3470 = 3910 + ?$

- (1) 280       (2) 210  
(3) 230       (4) 250  
(5) None of these

114.  $4\frac{3}{7} + 5\frac{4}{7} - 7\frac{9}{14} = ?$

- (1)  $5\frac{7}{14}$        (2)  $2\frac{7}{14}$   
(3)  $5\frac{2}{14}$        (4)  $2\frac{9}{14}$   
(5) None of these

115.  $20\% \text{ of } 530 + 36\% \text{ of } 6300 = ?$

- (1) 2268       (2) 2279  
(3) 2377       (4) 2374  
(5) None of these

116.  $24 + 45 \div 15 = ?$

- (1) 27       (2) 25  
(3) 21       (4) 23  
(5) None of these

117.  $7\frac{2}{3} - 4\frac{1}{3} = 4\frac{2}{3} - ?$

- (1)  $1\frac{1}{3}$        (2)  $2\frac{2}{3}$   
(3)  $1\frac{2}{3}$        (4)  $2\frac{1}{3}$   
(5) None of these

118.  $169 \times ? = 8788$

- (1) 52       (2) 57  
(3) 59       (4) 55  
(5) None of these

119.  $753 \times 13 \div 251 = ?$

- (1) 31       (2) 35  
(3) 39       (4) 37  
(5) None of these

120.  $48 + 1008 \div 9 \times 5 - 200 = ?$

- (1) 413       (2) 406  
(3) 408       (4) 418  
(5) None of these

121.  $\frac{6}{56} \times \frac{17}{3} \times ? = 102$

- (1) 161       (2) 168  
(3) 187       (4) 181  
(5) None of these

122.  $(26)^2 - (20)^2 = ?$

- (1) 268       (2) 276  
(3) 293       (4) 281  
(5) None of these

123.  $321 \times 25 - 8000 = (?)^2$

- (1)  $\pm 9$        (2)  $\pm 2$   
(3)  $\pm 7$        (4)  $\pm 5$   
(5) None of these

124.  $\sqrt{3969} = ?$

- (1) 69       (2) 53  
(3) 66       (4) 63  
(5) -66

125.  $47\% \text{ of } 1300 = 1833 \div ?$

- (1) 3       (2) 7  
(3) 5       (4) 9  
(5) None of these

126. How much will be the simple interest on a sum of ₹6,351 in a span of 7 years, at 5 p.c.p.a. ?

- (1) ₹ 2208.55  
(2) ₹ 2282.25  
(3) ₹ 2525.85  
(4) ₹ 2222.85  
(5) None of these

127. What will be the average of the following set of scores ?

- 29, 71, 56, 20, 38, 46, 41  
(1) 49       (2) 40  
(3) 44       (4) 47  
(5) 43

**Directions (128-130) :** Study the following information and answer the questions that follow :

Cost of 4 cushions and 3 chairs is ₹ 5,710. Cost of 7 cushions and 3 chairs is ₹ 7,522.

128. What is the difference between the cost of a chair and a cushion?

- (1) ₹238       (2) ₹494  
(3) ₹714       (4) ₹1,812  
(5) None of these

129. What is the cost of 5 chairs and 2 cushions ?

- (1) ₹ 4,118       (2) ₹ 6,698  
(3) ₹ 5,216       (4) ₹ 6,098  
(5) None of these

130. What is the cost of 2 chairs ?

- (1) ₹ 2,169       (2) ₹ 604  
(3) ₹ 1,208       (4) ₹ 1,812  
(5) None of these

131. The area of a square is 3364 square metre. What will be its perimeter?

- (1) 276 metre
- (2) 232 metre
- (3) 228 metre
- (4) 250 metre
- (5) None of these

132. The sum of three consecutive numbers is 897. What is the largest number?

- (1) 200            (2) 400
- (3) 300            (4) 500
- (5) None of these

133. In how many different ways can the letters of the word 'FLOWER' be arranged?

- (1) 600            (2) 120
- (3) 720            (4) 240
- (5) None of these

**Directions (134-136):** Study the following information and answer the questions that follow:

The annual salary of Rama is 40% the annual salary of Shyamla. The annual salary of Shyamla is 60% the annual salary of Heena. The salary of Heena is ₹43,200 per annum.

134. What is the sum of the annual salary of Shyamla and Rama?

- (1) ₹ 34,448    (2) ₹ 37,168
- (3) ₹ 36,288    (4) ₹ 99,861
- (5) ₹ 32,640

135. What is the difference between the monthly salary of Heena and Rama?

- (1) ₹ 2,496    (2) ₹ 2,736
- (3) ₹ 2,966    (4) ₹ 2,249
- (5) ₹ 2,046

136. How much is Rama's salary per annum?

- (1) ₹ 10,863    (2) ₹ 10,683
- (3) ₹ 10,548    (4) ₹ 10,448
- (5) ₹ 10,368

137. How much will ₹3,200 amount to at a compound interest rate of 5% in a span of 2 years?

- (1) ₹ 3,476    (2) ₹ 3,730
- (3) ₹ 3,528    (4) ₹ 3,675
- (5) ₹ 3,820

138. Sangeeta purchased 19 copies of a book for ₹ 6,840. How much did each copy cost?

- (1) ₹ 350            (2) ₹ 410
- (3) ₹ 370            (4) ₹ 380
- (5) ₹ 360

139. A and B are jogging on a circular track, starting from the same point. A completes one round of the track in 90 seconds and B completes one round of the same track in 75 seconds. After how much time will they meet each other at any common point on the track?

- (1) 5 minutes and 30 seconds
- (2) 6 minutes and 30 seconds
- (3) 7 minutes and 40 seconds
- (4) 7 minutes and 30 seconds
- (5) 6 minutes and 40 seconds

140. The present ages of Sushil and Sunil are in the ratio 7:10 respectively. Two years hence the ratio of their ages will be 5:7 respectively. How old will Sunil be when Sushil will be 35 years old?

- (1) 37 years    (2) 39 years
- (3) 41 years    (4) 47 years
- (5) 50 years

141. ₹760 are to be divided among A and B in the ratio 7:3 respectively. How much is the difference in the shares of A and B?

- (1) ₹ 304            (2) ₹ 228
- (3) ₹ 408            (4) ₹ 283
- (5) ₹ 320

142. The area of rectangle is 507 square metre. What is its perimeter if the length is thrice the breadth?

- (1) 104 metre    (2) 120 metre
- (3) 118 metre    (4) 130 metre
- (5) 93 metre

143. An article costs ₹790. If it is sold for ₹1,027, how much is the percentage profit?

- (1) 20            (2) 30
- (3) 35            (4) 25
- (5) 15

144. A can finish a work in 5 days and B can do it in 6 days. How many days will they take when working together?

- (1)  $2\frac{8}{11}$  days

- (2)  $3\frac{8}{11}$  days

- (3)  $1\frac{7}{11}$  days

- (4)  $2\frac{5}{11}$  days

- (5)  $7\frac{9}{11}$  days

145. A train crosses a pole in 17 seconds. If the length of the train is 425 metre, what will be the speed of the train in km/hour?

- (1) 90 km/hr    (2) 93 km/hr
- (3) 83 km/hr    (4) 87 km/hr
- (5) 80 km/hr

**Directions (146-150):** Study the following information and answer the questions that follow:

Of four subjects i.e. English, Maths, Science and Hindi, Mohan's average marks were 67. The maximum marks in English and Hindi were 60, and in Science and Maths were 80. Mohan obtained 95% and 97.5% marks in English and Maths respectively. He obtained 53 marks in Hindi.

146. What was Mohan's average score in English and Hindi together?

- (1) 45            (2) 53
- (3) 55            (4) 58
- (5) 49

147. What was Mohan's percentage score in Maths and Science together?

- (1) 96.35        (2) 98.75
- (3) 95.78        (4) 95.88
- (5) 98.77

148. What was his approximate percentage score in Hindi?

- (1) 83            (2) 79
- (3) 88            (4) 87
- (5) 75

149. What was Mohan's overall percentage score approximately?

- (1) 83            (2) 91
- (3) 89            (4) 85
- (5) 96

150. How many marks did Mohan obtain in Science?

- (1) 75            (2) 70
- (3) 80            (4) 79
- (5) 73



## OFFICE WORK APTITUDE

**Direction (151-185) :** In each question below a combination of Name and Address is given in the unnumbered column at the left followed by four such combinations one under each column (1), (2), (3) and (4). You have to find out the combination which is exactly the same as the combination in the unnumbered column. The number of that column which contains that combination is the answer. If all the combinations are different the answer is '(5)'.

	(1)	(2)	(3)	(4)	(5)
<b>151.</b> Mira Bhawan Silver Estates Grant Road Chandigarh	Mira Bhawan Silver Estates Grant Road Chandigarh	Mira Bhawan Silver Estates Grant Road Chandigarh	Mira Bhawan Silver Estate Grant Road Chandigarh	Mira Bhawan Silver Estates Grant Road Chandigrah	None
<b>152.</b> Priyadarshini 7 A, Race course Near temple New Delhi-100125	Priyadarshint 7 A, Race course Near tempal New Delhi-100125	Priyadarshini 7 A, Race course Near temple New Delhi-100215	Priyadarshini 7 A, Race coarse Near temple New Delhi-100125	Priyadarshini 7 A, Race course Near temple New Delhi-100125	None
<b>153.</b> Rahul Arora 25-N Near Talkies Bharuch-100533	Rahul Arora 25-N Near Talkies Bharuch-100533	Rahul Arora 25-N Near Talkies Bharuch-100353	Rahul Arora 25-M Near Talkies Bharuch-100533	Rahul Arora 25-N Near Talky Bharuch-100533	None
<b>154.</b> Asha Chandra 974 S.C. Bose Road Delhi - 100256	Asha Chandra 947 S.C. Bose Road Delhi - 100256	Asha Chandra 974 S.C. Bose Road Delhi - 100256	Asha Chander 974 S.C. Bose Road Delhi - 100256	Asha Chandra 974 C.S. Bose Road Delhi - 100256	None
<b>155.</b> Jaya Shrivastava 789/08 Sector 10 Bhagat Marg Lucknow-430025	Jaya Shrivastava 789/08 Sector 10 Bhagat Marg Lucknow-430055	Jaya Shrivastava 789/08 Sectar 10 Bhagat Marg Lucknow-430025	Jaya Shrivastava 798/08 Sector 10 Bhagat Marg Lucknow-430025	Jaya Shrivastava 789/08 Sector 10 Bhagat Marg Lucknow-430025	None
<b>156.</b> Gaurav Singh Sector 16, Near National Park Delhi-102360	Gaurav Singh Sector 16, Near Nation Park Delhi-102360	Gaurav Singh Sector 61, Near National Park Delhi-102360	Gaurav Singh Sector 16, Near National Park Delhi-102360	Gaurav Singh Sector 16, Near National Park Delhi-103260	None
<b>157.</b> Gayatri Parekh House no. 48 Kalkaji Marg Khandwa-200411	Gayatri Parekh House no. 48 Kalkaaji Marg Khandwa-200411	Gayatri Parekh House no. 48 Kalkaji Marg Khandwa-200141	Gayatri Parekh House no. 48 Kalkaji Marg Khandwa-200411	Gayatri Parekh House no. 84 Kalkaji Marg Khandwa-200411	None
<b>158.</b> Mansukh Das 523-A Matunga Mumbai-356002	Mansukh Das 523-A Matunga Mumbai-356002	Mansukh Das 523-K Matunga Mumbai-356002	Mansukh Das 532-A Matunga Mumbai-356002	Mansokh Das 523-A Matunga Mumbai-356002	None
<b>159.</b> Shalini Pandit 78 Avenue Palace Cross Society Chandigarh-624001	Shalini Pandit 87 Avenue Palace Cross Society Chandigarh-624001	Shalini Pandit 78 Avenue Palace Cross Society Chandigarh-624001	Shalini Pandit 78 Avenue Palace Cross Society Chandigarh-642001	Shalini Pandit 78 Avenue Place Cross Society Chandigarh-624001	None
<b>160.</b> Kusum Baweja 67-C Rajendra Nagar Bareilly-231241	Kusam Baweja 67-C Rajendra Nagar Bareilly-231241	Kusum Baweja 67-C Rajender Nagar Bareilly-231241	Kusum Baweja 76-C Rajendra Nagar Bareilly-231241	Kusum Baweja 67-C Rajendra Nagar Bareilly-231241	None
<b>161.</b> Chavi Jauhari House number 253 Thane-630036	Chabi Jauhari House number 253 Thane-630036	Chavi Jauhari House number 253 Thana-630036	Chavi Jauhari Hose number 253 Thane-630036	Chavi Jauhari House number 253 Thane-630036	None
<b>162.</b> Kamini Shukla Sector 31 Palace Road Bhopal-500030	Kamini Shukla Sector 31 Palace Road Bhopal-50030	Kamini Shukla Sector 31 Place Road Bhopal-500030	Kamini Shukla Sector 31 Palace Road Bhopal-500030	Kamini Shukla Sectur 31 Palace Road Bhopal-500030	None

<b>163.</b> S.Pharmaceuticals Gole Market Old Madras Chennai-400312	S.Pharmaceuticals Gole Market Old Madras Chennai-400312	S.Pharmaceuticals Gole Market Old Madras Chennai-400132	S.Pharmaceuticals Gole Market Old Madraas Chennai-400312	S.Pharmaceuticals Goel Market Old Madras Chennai-400312	None
<b>164.</b> Smita Pradhaan Pradhaan palace 19-B Delhi-1000120	Smiti Pradhaan Pradhaan palace 19-B Delhi-1000120	Smita Pradhaan Pradhaan palace 19-B Delhi-1000120	Smita Pradhan Pradhaan palace 19-B Delhi-1000120	Smita Pradhaan Pradhan palace 19-B Delhi-1000120	None
<b>165.</b> Nidhi Agarwal House number 245 Azad Chowk Kakori-600513	Nidhi Agarwal House number 245 Azad Chowk Kakori-600135	Nidhi Agarwal House number 245 Azad Chowk Kakori-600513	Nidhi Agarwal House number 245 Azad Chowk Kakori-600513	Nidhi Agarwal House number 254 Azad Chowk Kakori-600513	None
<b>166.</b> Sanket Shukla 6-A Society Near Bhawan Raipur-280001	Sanket Shukla 6-A Society Near Bhawan Raipur-280001	Sanket Shukhla 6-A Society Near Bhawan Raipur-280001	Sanket Shukla 6-A Society Near Bhavan Raipur-280001	Sanket Shukla 6-J Society Near Bhawan Raipur-280001	None
<b>167.</b> O. Prabhu Phase A Golden Adobe Jaipur-279006	O. Prabhu Phase A Golden Abode Jaipur-279006	O. Prabhu Phage A Golden Adobe Jaipur-279006	O. Prabhu Phase A Golden Adobe Jaipur-279006	D. Prabhu Phase A Golden Adobe Jaipur-279006	None
<b>168.</b> Swati Mishra building 16 Opposite Cinema Manmad-600321	Swati Mishra building 16 Opposite Cinmea Manmad-600321	Swati Mishra building 16 Opposite Cinema Manmad-600312	Swati Mishra buidding 16 Opposite Cinema Manmad-600321	Swati Mishra building 16 Opposite Cinema Manmad-600321	None
<b>169.</b> Samruddha Naagar Khan House Rani market road Dispur-234001	Samruddha Naagar Khan House Rani market road Dispur-234001	Samruddna Naagar Khan House Rani market road Dispur-234001	Samruddha Naagar Khan House Rani market road Dispur-243001	Samruddha Naagar Khan Home Rani market road Dispur-234001	None
<b>170.</b> Jayesh Jaiswal Villa Sector 64 Faridkot-500284	Jayesh Jaiswal Villas Sector 64 Faridkot-500284	Jayash Jaiswal Villa Sector 64 Faridkot-500284	Jayesh Jaiswal Villa Sector 64 Faridkot-500284	Jayesh Jaiswal Villa Sector 46 Faridkot-500284	None
<b>171.</b> Kaynat Saxena 9/854 Teg bahadur lane Leh-130170	Kaynaat Saxena 9/854 Teg bahadur lane Leh-130170	Kaynat Saxena 9/854 Teg bahadur lane Leh-130170	Kaynat Saxena 9/845 Teg bahadur lane Leh-130170	Kaynat Saxena 9/854 Teg bahadur line Leh-130170	None
<b>172.</b> Rachna Kapoor A-145 Indira Nagar Dehradun-401028	Rachan Kapoor A-145 Indira Nagar Dehradun-401028	Rachna Kapoor A-145 Indira Nager Dehradun-401028	Rachna Kapoor A-145 Indira Nagar Dehradun-401028	Rachna Kapour A-145 Indira Nagar Dehradun-401028	None
<b>173.</b> Anand Sinha 15/856 Ranipur Haridwar-401103	Anand Sinha 15/856 Ranipuri Haridwar-401103	Anand Sinha 15/856 Ranipur Haridwar-401103	Anand Singha 15/856 Ranipur Haridwar-401103	Anand Sinha 15/586 Ranipur Haridwar-401103	None
<b>174.</b> Vaibhav Varanjani Irish Cafe Mira Market Noida-200531	Vaibhav Varanjani Irish Cafe Mira Market Noida-200351	Vaibhav Varanjani Irish Cafe Miraa Market Noida-200531	Vaibhav Varanjani Irish Cafe Mira Market Noida-200531	Vaibhav Varajani Irish Cafe Mira Market Noida-200531	None
<b>175.</b> K.K. Parmar Ph-2563498 Fax- 589325	K.K. Parmar Ph-2563498 Tel- 589325	K.K. Parmar Ph-2569438 Fax- 589325	K.K. Parmer Ph-2563498 Fax- 589325	K.K. Parmar Ph-2563498 Fax- 589325	None

<b>176.</b> A. K. Kanojia Phase A Ram Prasad Tower Jodhpur-703005	A. K. Kanojia Phase A Ram Prasad Tower Jodhpur-703005	A. K. Kanujia Phase A Ram Prasad Tower Jodhpur-700305	A. K. Kanojia Phase K Ram Prasad Tower Jodhpur-703005	A. K. Kanojia Phase A Ram Parsad Tower Jodhpur-703005	None
<b>177.</b> Shuvashree Dutta 42/563 Geeta Nagri Saharanpur-500123	Shuvashree Dutta 42/653 Geeta Nagri Saharanpu-500123	Shuvashree Datta 42/563 Geeta Nagri Saharanpu-500123	Shuvashree Dutta 42/563 Geeta Nagari Saharanpu-500123	Shuvashree Dutta 24/563 Geeta Nagri Saharanpu-500123	None
<b>178.</b> Surjeet Singh Sector - 6 Near Post Office Shimla-230001	Surjit Singh Sector - 6 Near Post Office Shimla-230001	Surjeet Singh Sector - 6 Near Post Office Shimla-230001	Surjeet Singh Sector - 6 Near Post Office Shimla-200301	Surjeet Singh Sector - 6 Near Bank Office Shimla-230001	None
<b>179.</b> Pandey Industries Sector-9 Phase -7 Gurgaon-360001	Pandey Industries Sector-9 Phase -7 Gurgaon-360001	Pandey Industry Sector-9 Phase -7 Gurgaon-360001	Pandey Industries Sector-9 Phase -9 Gurgaon-360001	Pandey Industries Sector-7 Phase -7 Gurgaon-360001	None
<b>180.</b> Tanmoy Banerjee House no. 42 Vikas Nagar Surat-100102	Tanraoy Banerjee House no. 42 Vikas Nagar Surat-100102	Tanmoy Banerjee House no. 42 Vikas Nagar Surat-100102	Tanmoy Banerjee House no. 24 Vikas Nagar Surat-100102	Tanmoy Banerjee House no. 42 Vikas Nagari Surat-100102	None
<b>181.</b> Manisha Jain Krishna Kutir Near Rail station Pune-400107	Manishaa Jain Krishna Kutir Near Rail station Pune-400107	Manisha Jain Krishna Kutir Near Jail station Pune-400107	Manisha Jain Krishna Kutir Near Rail station Pune-400107	Manisha Jain Krishna Kutira Near Rail station Pune-400107	None
<b>182.</b> Ganga Alloys Ph- 5698321 Fax-4862531	Ganga Alloys Ph- 5698321 Tel-4862531	Ganga Alloy Ph- 5698321 Fax-4862531	Gangan Alloys Ph- 5698321 Fax-4862531	Ganga Alloys Ph- 5698321 Fax-4862531	None
<b>183.</b> Apex Merchants Ph - 6 128400 Fax - 5841 367	Apex Merchants Fax - 6 128400 Ph - 5841 367	Apex Merchants Ph - 6 128400 Tax - 5841 367	Apex Merchants Ph - 6 128400 Fax - 5841 367	Apex Merchants Phone - 6 128400 Fax - 5841 367	None
<b>184.</b> R.S. Enterprises Ph - 215896 Fax - 258423	R.S. Enterprises Ph - 215896 Fax - 258423	R.S. Enterprises Ph - 215896 Fax - 258243	R.S. Enterprises Ph - 251896 Fax - 258423	R.S. Enterprise Ph - 215896 Fax - 258423	None
<b>185.</b> Richa Gupta Bungalow no. 74 Prime locations Mehrauli-710107	Richa Gupta Bungalow no. 74 Prime locations Mehrauli-717107	Richa Gupta Bungalow no. 74 Prime location Mehrauli-710107	Richa Gupta Bungalow no. 47 Prime locations Mehrauli-71 0107	Richa Gupte Bungalow no. 74 Prime locations Mehrauli-710107	None

**Directions (186-190) :** Below in each question five words are given. Which of them will come in the third place if all of them are arranged alphabetically as in a dictionary ?

- 186.** (1) Flourish (2) Foster  
(3) Float (4) Flower  
(5) Fragrance

- 187.** (1) Hospitable  
(2) Host (3) House  
(4) Horticulture  
(5) Holster

- 188.** (1) Recoding  
(2) Recover  
(3) Recognise

- (4) Record (5) Receive  
**189.** (1) Variety (2) Vascular  
(3) Vapour (4) Variance  
(5) Vantage.

- 190.** (1) Concentrate  
(2) Concrete  
(3) Conceptual  
(4) Concurrent  
(5) Concert

**Directions (191-195) :** The news item in each question below is to be classified into one of the following five areas :

- (1) Politics (2) Sports  
(3) Business (4) Health  
(5) Weather

**191.** A leader of the opposition party has spoken sharply against a policy of the government in power.

- (1) Politics  
(2) Sports  
(3) Business  
(4) Health  
(5) Weather

**192.** A student of Indian origin wins a gold medal and a coveted title in swimming.

- (1) Politics (2) Sports  
(3) Business  
(4) Health  
(5) Weather

**193.** Polling in a particular constituency was held peacefully despite high pre-poll tension.

- (1) Politics (2) Sports  
(3) Business (4) Health  
(5) Weather

**194.** Various parts of North India are engulfed in dense fog. This has adversely affected the transport system.

- (1) Politics (2) Sports  
(3) Business (4) Health  
(5) Weather

**195.** A prominent brand that manufactures cars has launched a new car, keeping in trend with the demands of the market.

- (1) Politics (2) Sports  
(3) Business (4) Health  
(5) Weather

**Directions (196-200) :** The letter group in each question below is to be codified in the following number codes :

Letters	G	M	S	A	P	V	T	N	K	E
Number Codes	0	3	2	8	1	4	7	6	5	9

You have to find out which of the answers (1), (2), (3) or (4) has the correct coded form of the given letters. If none is correct coded form, give (5) i.e. 'None of these' as answer.

**196.** SNKMPGE

- (1) 2563109 (2) 2653019  
(3) 2635109 (4) 2653109  
(5) None of these

**197.** NGPMSKA

- (1) 6012358 (2) 6031258  
(3) 6013258 (4) 6012758  
(5) None of these

**198.** VEKTGPM

- (1) 4975013 (2) 4907513  
(3) 4957013 (4) 4957103  
(5) None of these

**199.** MVNETGK

- (1) 3469705 (2) 3469075  
(3) 3496705 (4) 3467905  
(5) None of these

**200.** TPASEMN

- (1) 7128936 (2) 7182936  
(3) 7812936 (4) 7182396  
(5) None of these

## ANSWERS

1. (4)	2. (2)	3. (1)	4. (1)
5. (5)	6. (5)	7. (2)	8. (4)
9. (3)	10. (3)	11. (4)	12. (2)
13. (2)	14. (5)	15. (3)	16. (4)
17. (1)	18. (3)	19. (1)	20. (5)
21. (2)	22. (5)	23. (2)	24. (1)
25. (4)	26. (3)	27. (3)	28. (4)
29. (1)	30. (5)	31. (3)	32. (4)
33. (5)	34. (3)	35. (1)	36. (4)
37. (2)	38. (2)	39. (5)	40. (1)
41. (2)	42. (3)	43. (1)	44. (4)
45. (3)	46. (5)	47. (2)	48. (1)
49. (4)	50. (5)	51. (4)	52. (1)
53. (3)	54. (2)	55. (1)	56. (3)
57. (4)	58. (2)	59. (3)	60. (5)
61. (3)	62. (1)	63. (4)	64. (2)
65. (1)	66. (4)	67. (2)	68. (4)
69. (5)	70. (2)	71. (4)	72. (2)
73. (3)	74. (3)	75. (1)	76. (1)
77. (5)	78. (4)	79. (3)	80. (3)
81. (2)	82. (4)	83. (1)	84. (3)
85. (3)	86. (4)	87. (5)	88. (1)
89. (5)	90. (3)	91. (1)	92. (1)
93. (4)	94. (4)	95. (2)	96. (5)
97. (2)	98. (3)	99. (2)	100. (5)
101. (5)	102. (4)	103. (1)	104. (4)
105. (5)	106. (1)	107. (4)	108. (2)
109. (5)	110. (3)	111. (2)	112. (4)
113. (5)	114. (5)	115. (4)	116. (1)
117. (1)	118. (1)	119. (3)	120. (3)
121. (2)	122. (2)	123. (4)	124. (4)
125. (1)	126. (4)	127. (5)	128. (2)
129. (2)	130. (3)	131. (2)	132. (3)
133. (3)	134. (3)	135. (2)	136. (5)
137. (3)	138. (5)	139. (4)	140. (4)
141. (1)	142. (1)	143. (2)	144. (1)
145. (1)	146. (3)	147. (2)	148. (3)
149. (5)	150. (3)	151. (2)	152. (4)
153. (1)	154. (2)	155. (4)	156. (3)
157. (3)	158. (1)	159. (2)	160. (4)
161. (4)	162. (3)	163. (1)	164. (2)
165. (3)	166. (1)	167. (3)	168. (4)
169. (1)	170. (3)	171. (2)	172. (3)
173. (2)	174. (3)	175. (4)	176. (1)
177. (5)	178. (2)	179. (1)	180. (2)
181. (3)	182. (4)	183. (3)	184. (1)
185. (5)	186. (4)	187. (1)	188. (3)
189. (4)	190. (5)	191. (1)	192. (2)
193. (1)	194. (5)	195. (3)	196. (4)
197. (3)	198. (3)	199. (1)	200. (2)

## EXPLANATIONS

1. (4)

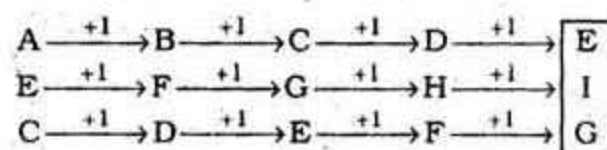

2. (2)

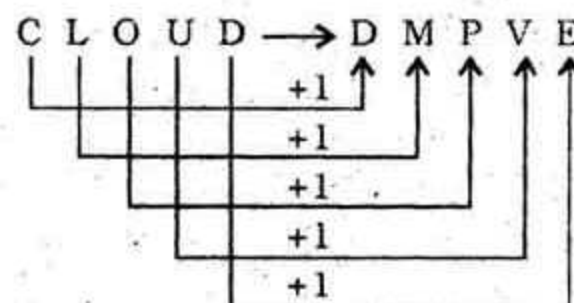
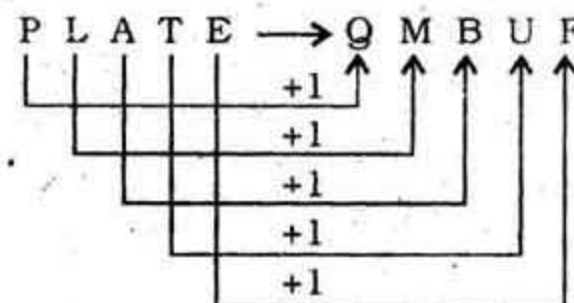

Similarly,

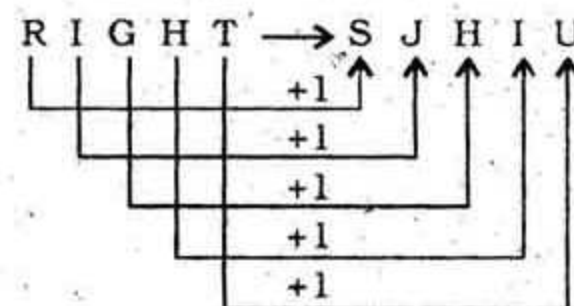

3. (1) Meaningful Word  $\Rightarrow$  FLAT

4. (1) 9 8 7 6 5 4 3 2 1 0  
9 8 7 6 5 4 3 2 1   
9 8 7 6 5 4 3 2    
9 8 7 6 5 4 3

9 .....

5. (5)

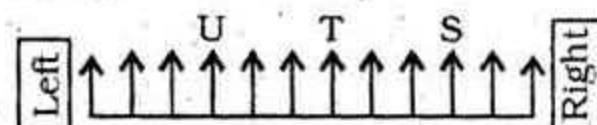

There are two students between T and U.

6. (5) A and B are children of H. C is uncle of A and B.

C is brother of H.

H is either brother or sister of C.

7. (2) Gold is a metal. Similarly, water is liquid.

8. (4) S C A L E D  
+1  $\downarrow$  +1  $\downarrow$  +1  $\downarrow$  +1  $\downarrow$  +1  $\downarrow$  +1  $\downarrow$   
T D B M F E  
B D E  F M T

9. (3) Rupee, Dollar, Yen and Dinar are currencies of different countries.

10. (3)

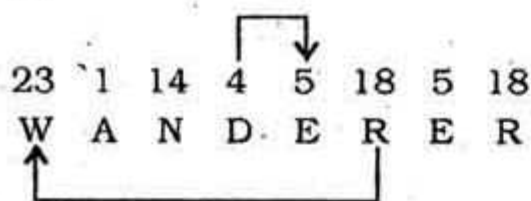

(11 - 15) :

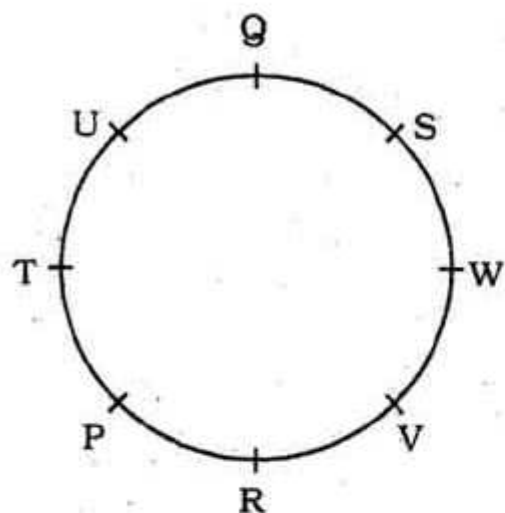

11. (4) There are two persons — R and V — between W and P.

12. (2)

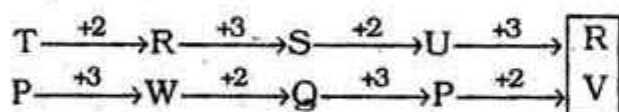

In anticlockwise direction.

13. (2) R is third to the left of S.

14. (5)

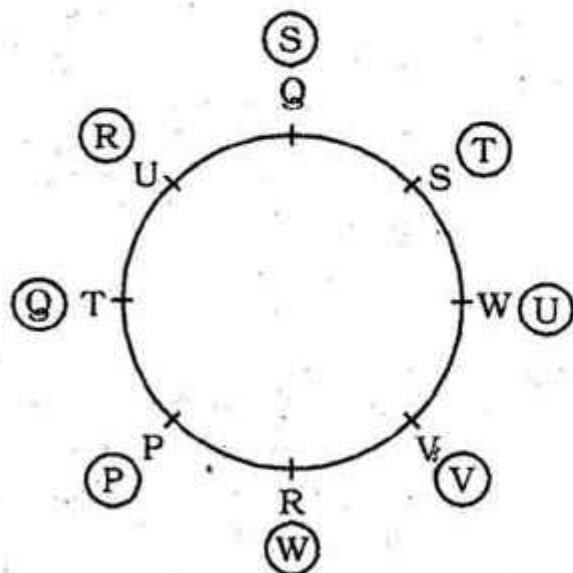

15. (3) Q is sitting exactly between S and U.

(16 - 20) :

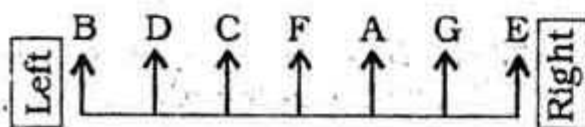

16. (4)

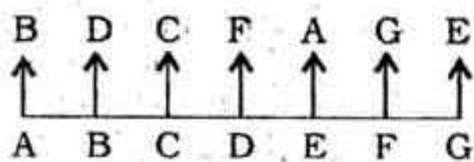

17. (1) C is second to the right of B.

18. (3) B and E are standing at the extreme ends of the line.

19. (1) Only G is between E and A.

20. (5) F is second to the right of D.

(21 - 25) :

(i) All villages are districts → Universal Affirmative (A-type).

(ii) Some colours are paints → Particular Affirmative (I-type).

(iii) No rice is wheat → Universal Negative (E-type).

(iv) Some rices are not wheat → Particular Negative (O-type).

21. (2) Both the Premises are Particular Affirmative (I-type). No Conclusion follows from the two Particular Premises. Conclusion II is Converse of the first Premise.

22. (5)

All villages are districts.

Some districts are countries.

A + I ⇒ No Conclusion

Conclusion I is Converse of the second Premise.

Conclusion II is Converse of the first Premise.

23. (2) All trucks are vans.

All vans are vehicles.

A + A ⇒ A-type of Conclusion "All trucks are vehicles".

This is Conclusion II.

24. (1) All grains are wheat.

No wheat is rice.

A + E ⇒ E-type of Conclusion "No grain is rice".

Conclusion I is Converse of it.

25. (4) Some dogs are cats.

No cat is a mouse.

I + E ⇒ O-type of Conclusion "Some dogs are not mouse".

26. (3) NIT ⇒ INT; CUB ⇒ BUC  
PAN ⇒ NAP; LEG ⇒ GEL;  
MOP ⇒ POM

BUC → GEL → [NAP] →

POM → TIN

Third from left ⇒ NAP ⇒ PAN

27. (3) NIT ⇒ INT; CUB ⇒ UCB;  
PAN ⇒ APN; LEG ⇒ ELG;

MOP ⇒ OMP

28. (4) NIT ⇒ INT; CUB ⇒ BCU;  
PAN ⇒ ANP; LEG ⇒ EGL;

MOP ⇒ MOP

29. (1) NIT ⇒ OIT; CUB ⇒ DUB;  
PAN ⇒ QAN; LEG ⇒ MEG;

MOP ⇒ NOP

30. (5) LEG ⇒ Its first letter is L.  
MOP ⇒ Its second letter is O.

L [MN] O

31. (3) Fifth letter from the left end ⇒ R

13th letter from the left end ⇒ T

Second letter from the right end ⇒ A

Meaningful Words ⇒ ART, RAT, TAR

32. (4) K +4 → U -2 → H

Z +4 → P -2 → T

I +4 → B -2 → J

P +5 → D -3 → W

G +4 → Q -2 → O

33. (5)

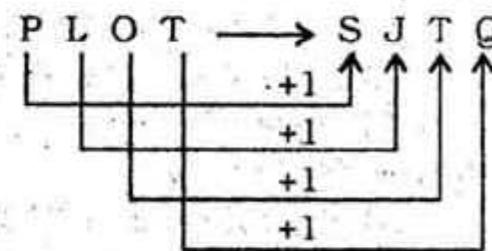
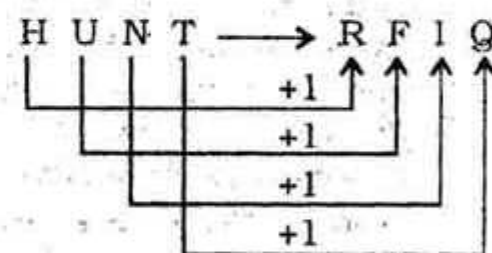

Similarly,

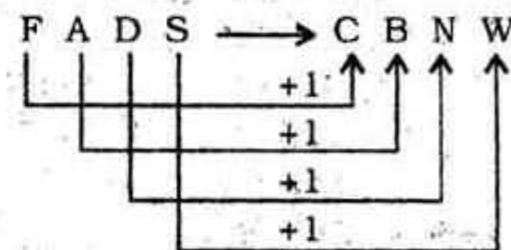

34. (3)

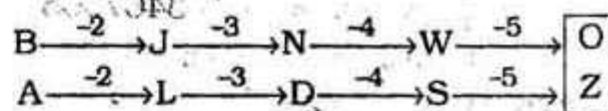

35. (1) 7th to the right of the 17th from the right end means 10th from the right end; i.e., W.

36. (4)  $F > G \geq H < I > J$

**Conclusions :**

I.  $F \geq I$  : Not True

II.  $G < J$  : Not True

37. (2)  $K > L \geq M = N < O$

**Conclusions :**

I.  $K < O$  : Not True

II.  $N \leq L$  : True

38. (2)  $A > B = C > D < E$

**Conclusions :**

I.  $E > B$  : Not True

II.  $A > D$  : True

39. (5)  $U < V = W \leq X = Y < Z$

**Conclusions :**

I.  $Z > U$  : True

II.  $V \leq Y$  : True

40. (1)  $P > Q < R = S \leq T$

**Conclusions :**

I.  $Q < T$  : True

II.  $P \leq T$  : Not True

41. (2)  $5 \ \& \ \% \ 8 \ 2 \ +$

↓ ↓ ↓ ↓ ↓ ↓

U S Y L T R

42. (3)  $\% \ 7 \ 3 \ @ \ 2 \ 9$

↓ ↓ ↓ ↓ ↓ ↓

W G D Z T Y

Condition (ii) is applicable.

43. (1)  $8 \ @ \ 4 \ \# \ 3 \ 7$

↓ ↓ ↓ ↓ ↓ ↓

L Z G H D G

Condition (i) is applicable.

44. (4)  $4 \ 2 \ 9 \ 5 \ 6 \ 3$

↓ ↓ ↓ ↓ ↓ ↓

C A W U F D

Condition (iii) is applicable.

45. (3)  $6 \ \# \ 8 \ + \ 5 \ 9$

↓ ↓ ↓ ↓ ↓ ↓

F H W R U W

Condition (i) is applicable.

(46-50) :

Day	Movie
Monday	C
Tuesday	A
Wednesday	E
Thursday	B
Friday	G
Saturday	D
Sunday	F

46. (5) Movie C will be screened on Monday.

47. (2) Movie D will be screened between Movies G and F.

48. (1) D will be screened on Saturday.  
A will be screened immediately before E.

No movie will be screened after F.

49. (4) Two movies — B and G — will be screened between E and D.

50. (5) Movie G will be screened on Friday.

67. (2) Phrase **Get away with something** means : to steal something and escape with it. Hence, get away with Meena's ..... should be used here.

68. (4) When two events happen in the past, the event that happens later is expressed in Past Simple.

Hence, the monsoon started should be used here.

70. (2) Here, were asked to ..... should be used.

Structure of the sentence in Passive Voice of Past Simple : Subject + was/were +  $V_3$  + by + Object.

71. (4) Here, the two parties (Plural) ..... should be used.

72. (2) It is not proper to use 'to' here.

73. (3) Here, it is an error of double superlatives.

Hence, the highest marks ..... should be used.

74. (3) Here, to defend (infinitive) himself but ..... should be used.

75. (1) Here, The children were should be used.

76. (1) The appropriate word should be : sell.

78. (4) The correct spelling is : meeting.

79. (3) The appropriate word should be : interrogating.

80. (3) The correct spelling is : reached.

96. (5) The word **Reward (Noun)** means : thing that you are given because you have done something good; prize.

97. (2) The word **Comprehend (Verb)** means : to understand something fully.

98. (3) The word **Mock (Verb)** means : make fun of; to laugh at somebody/something in an unkind way; tease.

99. (2) The word **Selfish (Adjective)** means : caring about yourself rather than about other people.

The word **Generous (Adjective)** means : giving or willing to give freely.

100. (5) The word **Content (Adjective)** means : happy and satisfied with what you have. Its antonym should be **unhappy**.

101. (5)  $? = \sqrt[3]{2197} = \sqrt[3]{13 \times 13 \times 13} = 13$

102. (4)  $? = 2451 + 7983 - 3451 = 6983$

103. (1)  $? = \frac{140}{28} \times \frac{234}{338} \times 13 = 45$

104. (4)  $\frac{4370}{19} = 100 + ?$

$\Rightarrow 230 = 100 + ?$

$\Rightarrow ? = 230 - 100 = 130$

105. (5)  $\frac{1.8 \times 3.2}{?} = 2.88$

$\Rightarrow 2.88 \times ? = 1.8 \times 3.2$

$\Rightarrow ? = \frac{1.8 \times 3.2}{2.88} = 2$

106. (1)  $(51 + 9) \div 3 = 5 \times (?)^2$

$\Rightarrow 60 \div 3 = 5 \times (?)^2$

$\Rightarrow \frac{20}{5} = (?)^2$

$\Rightarrow ?^2 = 4 \Rightarrow ? = \pm 2$

107. (4)  $? \times 25 = 550 - 225 = 325$

$\Rightarrow ? = \frac{325}{25} = 13$

108. (2)  $\frac{6.4}{4} \times ? + 2.51 = 2.85$

$\Rightarrow 1.7 \times ? = 2.85 - 2.51 = 0.34$

$\Rightarrow ? = \frac{0.34}{1.7} = 0.2$

109. (5)  $\frac{540 \times 30}{18 \times ?} = 60$

$\Rightarrow 60 \times 18 \times ? = 540 \times 30$

$\Rightarrow ? = \frac{540 \times 30}{60 \times 18} = 15$

110. (3)  $? \times \frac{5.28}{100} = 491.04$

$\Rightarrow ? = \frac{491.04 \times 100}{5.28} = 9300$

$$111. (2) ? = \frac{6.13 \times 2.8}{0.7} = 24.52$$

$$112. (4) ? = 19.21 + 12.91 + 91.12 + 29.11 = 152.35$$

$$113. (5) 3910 + ? = 3180 - 2450 + 3470 \\ \Rightarrow 3910 + ? = 4200 \\ \Rightarrow ? = 4200 - 3910 = 290$$

$$114. (5) ? = 4 + \frac{3}{7} + 5 + \frac{4}{7} - 7 - \frac{9}{14} \\ = (4 + 5 - 7) + \left(\frac{3}{7} + \frac{4}{7}\right) - \frac{9}{14}$$

$$= 2 + 1 - \frac{9}{14} = 2 \frac{5}{14}$$

$$115. (4) ? = \frac{530 \times 20}{100} + \frac{6300 \times 36}{100} \\ = 106 + 2268 = 2374$$

$$116. (1) ? = 24 + \frac{45}{15} = 24 + 3 = 27$$

$$117. (1) 7\frac{2}{3} - 4\frac{1}{3} = 4\frac{2}{3} - ?$$

$$\Rightarrow \frac{23}{3} - \frac{13}{3} = \frac{14}{3} - ?$$

$$\Rightarrow \frac{10}{3} = \frac{14}{3} - ?$$

$$\Rightarrow ? = \frac{14}{3} - \frac{10}{3} = \frac{4}{3} = 1\frac{1}{3}$$

$$118. (1) 169 \times ? = 8788$$

$$\Rightarrow ? = \frac{8788}{169} = 52$$

$$119. (3) ? = \frac{753 \times 13}{251} = 39$$

$$120. (3) ? = 48 + \frac{1008}{9} \times 5 - 200 \\ = 48 + 560 - 200 = 408$$

$$121. (2) \frac{6}{56} \times \frac{17}{3} \times ? = 102$$

$$\Rightarrow ? = \frac{102 \times 56 \times 3}{6 \times 17} = 168$$

$$122. (2) ? = (26)^2 - (20)^2 \\ = (26 + 20)(26 - 20) \\ = 46 \times 6 = 276$$

$$123. (4) (?)^2 = 321 \times 25 - 8000 \\ = 8025 - 8000 = 25$$

$$\therefore ? = \sqrt{25} = \pm 5$$

$$124. (4) ? = \sqrt{3969} = 63$$

$$125. (1) \frac{1300 \times 47}{100} = \frac{1833}{?}$$

$$\Rightarrow 611 = \frac{1833}{?}$$

$$\Rightarrow 611 \times ? = 1833$$

$$\Rightarrow ? = \frac{1833}{611} = 3$$

126. (4) S.I.

$$= \frac{\text{Principal} \times \text{Rate} \times \text{Time}}{100}$$

$$= \frac{6351 \times 5 \times 7}{100}$$

$$= \text{Rs. } 2222.85$$

127. (5) Required average

$$= \frac{29 + 71 + 56 + 20 + 38 + 46 + 41}{7}$$

$$= \frac{301}{7} = 43$$

(128 - 130) :

CP of 1 cushion = Rs.  $x$

CP of 1 chair = Rs.  $y$

$$\therefore 4x + 3y = 5710 \quad \dots\dots (i)$$

$$7x + 3y = 7522 \quad \dots\dots (ii)$$

By equation (ii) - equation (i),

$$3x = 7522 - 5710 = 1812$$

$$\Rightarrow x = \frac{1812}{3} = \text{Rs. } 604$$

From equation (i),

$$4 \times 604 + 3y = 5710$$

$$\Rightarrow 2416 + 3y = 5710$$

$$\Rightarrow 3y = 5710 - 2416 = 3294$$

$$\Rightarrow y = \frac{3294}{3} = \text{Rs. } 1098$$

128. (2) Required difference

$$= 1098 - 604 = \text{Rs. } 494$$

129. (2) Required answer

$$= \text{Rs. } (5 \times 1098 + 2 \times 604)$$

$$= \text{Rs. } (5490 + 1208)$$

$$= \text{Rs. } 6698$$

130. (3) Required cost

$$= 2 \times 604 = \text{Rs. } 1208$$

131. (2) Side of a square =  $\sqrt{\text{Area}}$

$$= \sqrt{3364} = 58 \text{ metre}$$

$\therefore$  Perimeter of square

$$= 4 \times 58 = 232 \text{ metre}$$

$$132. (3) x + x + 1 + x + 2 = 897$$

$$\Rightarrow 3x + 3 = 897$$

$$\Rightarrow 3x = 897 - 3 = 894$$

$$\Rightarrow x = \frac{894}{3} = 298$$

$$\therefore \text{Largest number} = 298 + 2 = 300$$

133. (3) The word FLOWER consists of 6 distinct letters.

$$\therefore \text{Number of arrangements} = 6! \\ = 6 \times 5 \times 4 \times 3 \times 2 \times 1 = 720$$

**Calculations (134 - 136)**

Shyamla's annual salary

$$= \frac{43200 \times 60}{100}$$

$$= \text{Rs. } 25920$$

Rama's annual salary

$$= \frac{25920 \times 40}{100}$$

$$= \text{Rs. } 10368$$

134. (3) Sum of the annual salaries of Shyamla and Rama

$$= \text{Rs. } (25920 + 10368)$$

$$= \text{Rs. } 36288$$

135. (2) Required difference

$$= \frac{1}{12} (43200 - 10368)$$

$$= \frac{1}{12} \times 32832$$

$$= \text{Rs. } 2736$$

136. (5) Rama's annual salary

$$= \text{Rs. } 10368$$

$$137. (3) A = P \left(1 + \frac{R}{100}\right)^T$$

$$= 3200 \left(1 + \frac{5}{100}\right)^2$$

$$= 3200 \left(\frac{21}{20}\right)^2$$

$$= \frac{3200 \times 21 \times 21}{20 \times 20}$$

$$= \text{Rs. } 3528$$

138. (5) Cost of each book

$$= \frac{6840}{19} = \text{Rs. } 360$$

139. (4) Required time

$$= \text{LCM of } 90 \text{ and } 75 \text{ seconds}$$

$$= 450 \text{ seconds}$$

$$= 7 \text{ minutes } 30 \text{ seconds}$$

**140.** (4) Sushil's present age  
=  $7x$  years

Sunil's present age  
=  $10x$  years

After 2 years,

$$\frac{7x+2}{10x+2} = \frac{5}{7}$$

$$\Rightarrow 50x+10 = 49x+14$$

$$\Rightarrow x = 14 - 10 = 4$$

Sushil's age after 7 years

$$= 7 \times 4 + 7 = 25 \text{ years}$$

Sunil's age after 7 years

$$= 10 \times 4 + 7 = 47 \text{ years}$$

**141.** (1) Required difference

$$= \frac{7-3}{10} (760)$$

$$= \frac{4}{10} \times 760 = \text{Rs. } 304$$

**142.** (1) Breadth =  $x$  metre

Length =  $3x$  metre

$$\therefore 3x \times x = 507$$

$$\Rightarrow x^2 = \frac{507}{3} = 169$$

$$\Rightarrow x = \sqrt{169} = 13$$

$\therefore$  Perimeter of rectangle

$$= 2(3x+x) = 8x$$

$$= 8 \times 13 = 104 \text{ metre}$$

**143.** (2) Percentage profit

$$= \frac{(1027 - 790)}{790} \times 100$$

$$= \frac{23700}{790} = 30\%$$

**144.** (1) (A + B)'s 1 day's work

$$= \frac{1}{5} + \frac{1}{6} = \frac{5+6}{30} = \frac{11}{30}$$

Hence, both will together

complete the work in  $\frac{30}{11}$

$$= 2\frac{8}{11} \text{ days.}$$

**145.** (1) When a train crosses a pole, it covers a distance equal to its length.

$\therefore$  Speed of train

$$= \left(\frac{425}{17}\right) \text{ m/sec.}$$

$$= \left(\frac{425}{17} \times \frac{18}{5}\right) \text{ kmph.}$$

$$= 90 \text{ kmph}$$

**Calculations (146 - 150) :**

Marks obtained by Mohan :

$$\text{English} \Rightarrow \frac{60 \times 95}{100} = 57$$

$$\text{Hindi} \Rightarrow 53$$

$$\text{Maths} \Rightarrow \frac{80 \times 97.5}{100} = 78$$

$$\text{Science} \Rightarrow (4 \times 67 - 57 - 53 - 78) = 80$$

**146.** (3) Required average marks

$$= \frac{57 + 53}{2} = \frac{110}{2} = 55$$

**147.** (2) Maths + Science

$$= 78 + 80 = 158$$

$$\text{Total marks} = 160$$

$\therefore$  Required percentage

$$= \frac{158}{160} \times 100 = 98.75$$

**148.** (3) Required percentage

$$= \frac{53}{60} \times 100 \approx 88$$

**149.** (5) Required overall percent-

$$\text{age} = \frac{268}{280} \times 100 \approx 96$$

**150.** (3) Marks of Mohan in Science  
= 80

**186.** (4) Alphabetical order of words :

(3) Float

↓

(1) Flourish

↓

(4) Flower

↓

(2) Foster

↓

(5) Fragrance

**187.** (1) Alphabetical order of words :

(5) Holster

↓

(4) Horticulture

↓

(1) Hospitable

↓

(2) Host

↓

(3) House

**188.** (3) Alphabetical order of words :

(5) Receive

↓

(1) Recoding

↓

(3) Recognise

↓

(4) Record

↓

(2) Recover

**189.** (4) Alphabetical order of words :

(5) Vantage

↓

(3) Vapour

↓

(4) Variance

↓

(1) Variety

↓

(2) Vascular

**190.** (5) Alphabetical order of words :

(1) Concentrate

↓

(3) Conceptual

↓

(5) Concert

↓

(2) Concrete

↓

(4) Concurrent

**196.** (4) S N K M P G E

↓ ↓ ↓ ↓ ↓ ↓ ↓

2 6 5 3 1 0 9

**197.** (3) N G P M S K A

↓ ↓ ↓ ↓ ↓ ↓ ↓

6 0 1 3 2 5 8

**198.** (3) V E K T G P M

↓ ↓ ↓ ↓ ↓ ↓ ↓

4 9 5 7 0 1 3

**199.** (1) M V N E T G K

↓ ↓ ↓ ↓ ↓ ↓ ↓

3 4 6 9 7 0 5

**200.** (2) T P A S E M N

↓ ↓ ↓ ↓ ↓ ↓ ↓

7 1 8 2 9 3 6