

GRADUATE RECORD EXAMINATIONS®

Physics Test Practice Book

This practice book contains

- one actual, full-length GRE® Physics Test
- test-taking strategies

Become familiar with

- test structure and content
- test instructions and answering procedures

Compare your practice test results with the performance of those who took the test at a GRE administration.

Visit GRE Online at www.ets.org/gre

Note to Test Takers: Keep this practice book until you receive your score report.
This book contains important information about scoring.

Copyright © 2011 by Educational Testing Service. All rights reserved.
ETS, the ETS logos, LISTENING. LEARNING. LEADING., GRADUATE RECORD
EXAMINATIONS, and GRE are registered trademarks of Educational Testing Service (ETS)
in the United States and other countries.

Table of Contents

Purpose of the GRE Subject Tests	3
Development of the Subject Tests	3
Content of the Physics Test	4
Preparing for a Subject Test	5
Test-Taking Strategies	6
What Your Scores Mean	6
Practice GRE Physics Test	9
Scoring Your Subject Test	89
Evaluating Your Performance	92
Answer Sheet	93

Purpose of the GRE Subject Tests

The GRE Subject Tests are designed to help graduate school admission committees and fellowship sponsors assess the qualifications of applicants in specific fields of study. The tests also provide you with an assessment of your own qualifications.

Scores on the tests are intended to indicate knowledge of the subject matter emphasized in many undergraduate programs as preparation for graduate study. Because past achievement is usually a good indicator of future performance, the scores are helpful in predicting success in graduate study. Because the tests are standardized, the test scores permit comparison of students from different institutions with different undergraduate programs. For some Subject Tests, subscores are provided in addition to the total score; these subscores indicate the strengths and weaknesses of your preparation, and they may help you plan future studies.

The GRE Board recommends that scores on the Subject Tests be considered in conjunction with other relevant information about applicants. Because numerous factors influence success in graduate school, reliance on a single measure to predict success is not advisable. Other indicators of competence typically include undergraduate transcripts showing courses taken and grades earned, letters of recommendation, and GRE General Test scores. For information about the appropriate use of GRE scores, see the

GRE Guide to the Use of Scores at
www.ets.org/gre/subject/scores/understand.

Development of the Subject Tests

Each new edition of a Subject Test is developed by a committee of examiners composed of professors in the subject who are on undergraduate and graduate faculties in different types of institutions and in different regions of the United States and Canada. In selecting members for each committee, the GRE Program seeks the advice of appropriate professional associations in the subject.

The content and scope of each test are specified and reviewed periodically by the committee of examiners. Test questions are written by committee members and by other university faculty members who are subject-matter specialists. All questions proposed for the test are reviewed and revised by the committee and subject-matter specialists at ETS. The tests are assembled in accordance with the content specifications developed by the committee to ensure adequate coverage of the various aspects of the field and, at the same time, to prevent overemphasis on any single topic. The entire test is then reviewed and approved by the committee.

Subject-matter and measurement specialists on the ETS staff assist the committee, providing information and advice about methods of test construction and helping to prepare the questions and assemble the test. In addition, each test question is reviewed to eliminate language, symbols, or content considered potentially offensive, inappropriate for major subgroups of the test-taking population, or likely to perpetuate any negative attitude that may be conveyed to these subgroups.

Because of the diversity of undergraduate curricula, it is not possible for a single test to cover all the material you may have studied. The examiners, therefore, select questions that test the basic knowledge and skills most important for successful graduate study in the particular field. The committee keeps the test up-to-date by regularly developing new editions and revising existing editions. In this way, the test content remains current. In addition, curriculum surveys are conducted periodically to ensure that the content of a test reflects what is currently being taught in the undergraduate curriculum.

After a new edition of a Subject Test is first administered, examinees' responses to each test question are analyzed in a variety of ways to determine whether each question functioned as expected. These analyses may reveal that a question is ambiguous, requires knowledge beyond the scope of the test, or is inappropriate for the total group or a particular subgroup of examinees taking the test. Such questions are not used in computing scores.

Following this analysis, the new test edition is equated to an existing test edition. In the equating process, statistical methods are used to assess the difficulty of the new test. Then scores are adjusted so that examinees who took a more difficult edition of the test are not penalized, and examinees who took an easier edition of the test do not have an advantage. Variations in the number of questions in the different editions of the test are also taken into account in this process.

Scores on the Subject Tests are reported as three-digit scaled scores with the third digit always zero. The maximum possible range for all Subject Test total scores is from 200 to 990. The actual range of scores for a particular Subject Test, however, may be smaller. For Subject Tests that report subscores, the maximum possible range is 20 to 99; however, the actual range of subscores for any test or test edition may be smaller. Subject Test score interpretive information is provided in *Interpreting Your GRE Scores*, which you will receive with your GRE score report. This publication is also available at www.ets.org/gre/subject/scores/understand.

Content of the Physics Test

- The test consists of approximately 100 five-choice questions, some of which are grouped in sets and based on such materials as diagrams, graphs, experimental data and descriptions of physical situations.
- The aim of the test is to determine the extent of the examinees' grasp of fundamental principles and their ability to apply these principles in the solution of problems.
- Most test questions can be answered on the basis of a mastery of the first three years of undergraduate physics.
- The test questions are constructed to simplify mathematical manipulations. As a result, neither

calculators nor tables of logarithms are needed. If the solution to a problem requires the use of logarithms, the necessary values are included with the question.

- The International System (SI) of units is used predominantly in the test. A table of information representing various physical constants and a few conversion factors among SI units is presented in the test book. Whenever necessary, additional values of physical constants are printed with the text of the question.
 - The approximate percentages of the test on the major content topics have been set by the committee of examiners, with input from a nationwide survey of undergraduate physics curricula. The percentages reflect the committee's determination of the relative emphasis placed on each topic in a typical undergraduate program. These percentages are given below along with the major subtopics included in each content category.
 - Nearly all the questions in the test will relate to material in this listing; however, there may be occasional questions on other topics not explicitly listed here.
- | | |
|---|-----|
| 1. CLASSICAL MECHANICS (such as kinematics, Newton's laws, work and energy, oscillatory motion, rotational motion about a fixed axis, dynamics of systems of particles, central forces and celestial mechanics, three-dimensional particle dynamics, Lagrangian and Hamiltonian formalism, noninertial reference frames, elementary topics in fluid dynamics) | 20% |
| 2. ELECTROMAGNETISM (such as electrostatics, currents and DC circuits, magnetic fields in free space, Lorentz force, induction, Maxwell's equations and their applications, electromagnetic waves, AC circuits, magnetic and electric fields in matter) | 18% |
| 3. OPTICS AND WAVE PHENOMENA (such as wave properties, superposition, interference, diffraction, geometrical optics, polarization, Doppler effect) | 9% |
| 4. THERMODYNAMICS AND STATISTICAL MECHANICS (such as the laws of thermodynamics, thermodynamic pro- | 10% |

cesses, equations of state, ideal gases, kinetic theory, ensembles, statistical concepts and calculation of thermodynamic quantities, thermal expansion and heat transfer)

5. QUANTUM MECHANICS (such as fundamental concepts, solutions of the Schrödinger equation (including square wells, harmonic oscillators, and hydrogenic atoms), spin, angular momentum, wave function symmetry, elementary perturbation theory) 12%
6. ATOMIC PHYSICS (such as properties of electrons, Bohr model, energy quantization, atomic structure, atomic spectra, selection rules, black-body radiation, x-rays, atoms in electric and magnetic fields) 10%
7. SPECIAL RELATIVITY (such as introductory concepts, time dilation, length contraction, simultaneity, energy and momentum, four-vectors and Lorentz transformation, velocity addition) 6%
8. LABORATORY METHODS (such as data and error analysis, electronics, instrumentation, radiation detection, counting statistics, interaction of charged particles with matter, lasers and optical interferometers, dimensional analysis, fundamental applications of probability and statistics) 6%
9. SPECIALIZED TOPICS: Nuclear and Particle physics (e.g., nuclear properties, radioactive decay, fission and fusion, reactions, fundamental properties of elementary particles), Condensed Matter (e.g., crystal structure, x-ray diffraction, thermal properties, electron theory of metals, semiconductors, superconductors), Miscellaneous (e.g., astrophysics, mathematical methods, computer applications) 9%

Those taking the test should be familiar with certain mathematical methods and their applications in physics. Such mathematical methods include single and multivariate calculus, coordinate systems (rectangular, cylindrical and spherical), vector algebra and vector differential operators, Fourier series, partial differential equations, boundary value problems, matrices and determinants, and functions of complex variables. These methods may appear in the test in the context of various content categories as well as occasional questions concerning only mathematics in the specialized topics category above.

Preparing for a Subject Test

GRE Subject Test questions are designed to measure skills and knowledge gained over a long period of time. Although you might increase your scores to some extent through preparation a few weeks or months before you take the test, last minute cramming is unlikely to be of further help. The following information may be helpful.

- A general review of your college courses is probably the best preparation for the test. However, the test covers a broad range of subject matter, and no one is expected to be familiar with the content of every question.
- Use this practice book to become familiar with the types of questions in the GRE Physics Test, taking note of the directions. If you understand the directions before you take the test, you will have more time during the test to focus on the questions themselves.

Test-Taking Strategies

The questions in the practice test in this book illustrate the types of multiple-choice questions in the test. When you take the actual test, you will mark your answers on a separate machine-scorable answer sheet. Total testing time is two hours and fifty minutes; there are no separately timed sections. Following are some general test-taking strategies you may want to consider.

- Read the test directions carefully, and work as rapidly as you can without being careless. For each question, choose the best answer from the available options.
- All questions are of equal value; do not waste time pondering individual questions you find extremely difficult or unfamiliar.
- You may want to work through the test quite rapidly, first answering only the questions about which you feel confident, then going back and answering questions that require more thought, and concluding with the most difficult questions if there is time.
- If you decide to change an answer, make sure you completely erase it and fill in the oval corresponding to your desired answer.
- Questions for which you mark no answer or more than one answer are not counted in scoring.
- Your score will be determined by subtracting one-fourth the number of incorrect answers from the number of correct answers. If you have some knowledge of a question and are able to rule out one or more of the answer choices as incorrect, your chances of selecting the correct answer are improved, and answering such questions will likely improve your score. It is unlikely that pure guessing will raise your score; it may lower your score.
- Record all answers on your answer sheet. Answers recorded in your test book will not be counted.
- Do not wait until the last five minutes of a testing session to record answers on your answer sheet.

What Your Scores Mean

Your raw score — that is, the number of questions you answered correctly minus one-fourth of the number you answered incorrectly — is converted to the scaled score that is reported. This conversion ensures that a scaled score reported for any edition of a Subject Test is comparable to the same scaled score earned on any other edition of the same test. Thus, equal scaled scores on a particular Subject Test indicate essentially equal levels of performance regardless of the test edition taken. Test scores should be compared only with other scores on the same Subject Test. (For example, a 680 on the Physics Test is not equivalent to a 680 on the Mathematics Test.)

Before taking the test, you may find it useful to know approximately what raw scores would be required to obtain a certain scaled score. Several factors influence the conversion of your raw score to your scaled score, such as the difficulty of the test edition and the number of test questions included in the computation of your raw score. Based on recent editions of the Physics Test, the following table gives the range of raw scores associated with selected scaled scores for three different test editions. (Note that when the number of scored questions for a given test is greater than the number of actual scaled score points, it is likely that two or more raw scores will convert to the same scaled score.) The three test editions in the table that follows were selected to reflect varying degrees of difficulty. Examinees should note that future test editions may be somewhat more or less difficult than the test editions illustrated in the table.

**Range of Raw Scores* Needed to Earn
Selected Scaled Scores on Three
Physics Test Editions That
Differ in Difficulty**

Scaled Score	Raw Scores		
	Form A	Form B	Form C
900	79	75-76	72
800	69	62	60
700	57	48-49	46-47
600	41-42	34	32
Number of Questions Used to Compute Raw Score			
	100	100	100

*Raw Score = Number of correct answers minus one-fourth the number of incorrect answers, rounded to the nearest integer.

For a particular test edition, there are many ways to earn the same raw score. For example, on the edition listed above as “Form A,” a raw score of 57 would earn a scaled score of 700. Below are a few of the possible ways in which a scaled score of 700 could be earned on the edition.

**Examples of Ways to Earn
a Scaled Score of 700 on the
Edition Labeled as “Form A”**

Raw Score	Questions Answered Correctly	Questions Answered Incorrectly	Questions Not Answered	Number of Questions Used to Compute Raw Score
57	57	0	43	100
57	61	17	22	100
57	65	34	1	100

Practice Test

To become familiar with how the administration will be conducted at the test center, first remove the answer sheet (pages 93 and 94). Then go to the back cover of the test book (page 88) and follow the instructions for completing the identification areas of the answer sheet. When you are ready to begin the test, note the time and begin marking your answers on the answer sheet.



GRE

FORM GR0877

77

GRADUATE RECORD EXAMINATIONS®

PHYSICS TEST

*Do not break the seal
until you are told to do so.*

*The contents of this test are confidential.
Disclosure or reproduction of any portion
of it is prohibited.*

THIS TEST BOOK MUST NOT BE TAKEN FROM THE ROOM.

Copyright © 2008 by Educational Testing Service. All rights reserved.
GRE, GRADUATE RECORD EXAMINATIONS, ETS, EDUCATIONAL TESTING
SERVICE and the ETS logos are registered trademarks of Educational Testing Service.

TABLE OF INFORMATION

Rest mass of the electron	$m_e = 9.11 \times 10^{-31} \text{ kg}$
Magnitude of the electron charge	$e = 1.60 \times 10^{-19} \text{ C}$
Avogadro's number	$N_A = 6.02 \times 10^{23}$
Universal gas constant	$R = 8.31 \text{ J}/(\text{mol} \cdot \text{K})$
Boltzmann's constant	$k = 1.38 \times 10^{-23} \text{ J/K}$
Speed of light	$c = 3.00 \times 10^8 \text{ m/s}$
Planck's constant	$h = 6.63 \times 10^{-34} \text{ J} \cdot \text{s} = 4.14 \times 10^{-15} \text{ eV} \cdot \text{s}$ $\hbar = h/2\pi$ $hc = 1240 \text{ eV} \cdot \text{nm}$
Vacuum permittivity	$\epsilon_0 = 8.85 \times 10^{-12} \text{ C}^2/(\text{N} \cdot \text{m}^2)$
Vacuum permeability	$\mu_0 = 4\pi \times 10^{-7} \text{ T} \cdot \text{m/A}$
Universal gravitational constant	$G = 6.67 \times 10^{-11} \text{ m}^3/(\text{kg} \cdot \text{s}^2)$
Acceleration due to gravity	$g = 9.80 \text{ m/s}^2$
1 atmosphere pressure	$1 \text{ atm} = 1.0 \times 10^5 \text{ N/m}^2 = 1.0 \times 10^5 \text{ Pa}$
1 angstrom	$1 \text{ \AA} = 1 \times 10^{-10} \text{ m} = 0.1 \text{ nm}$

Prefixes for Powers of 10

10^{-15}	femto	f
10^{-12}	pico	p
10^{-9}	nano	n
10^{-6}	micro	μ
10^{-3}	milli	m
10^{-2}	centi	c
10^3	kilo	k
10^6	mega	M
10^9	giga	G
10^{12}	tera	T
10^{15}	peta	P

Rotational inertia about center of mass

Rod	$\frac{1}{12} M\ell^2$
Disc	$\frac{1}{2} MR^2$
Sphere	$\frac{2}{5} MR^2$

This test starts on page 12.

PHYSICS TEST

Time—170 minutes

100 Questions

Directions: Each of the questions or incomplete statements below is followed by five suggested answers or completions. Select the one that is best in each case and then fill in the corresponding space on the answer sheet.

1. A ball is thrown out of the passenger window of a car moving to the right (ignore air resistance). If the ball is thrown out perpendicular to the velocity of the car, which of the following best depicts the path the ball takes, as viewed from above?

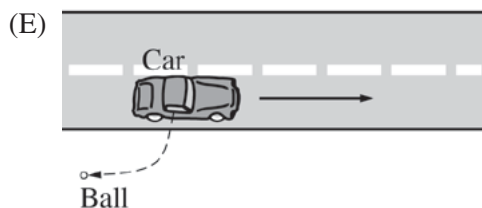
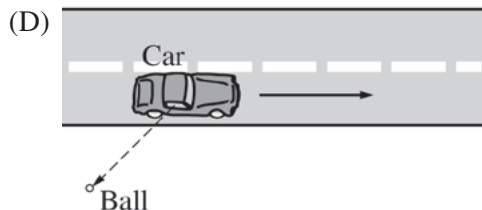
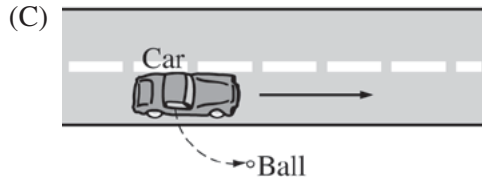
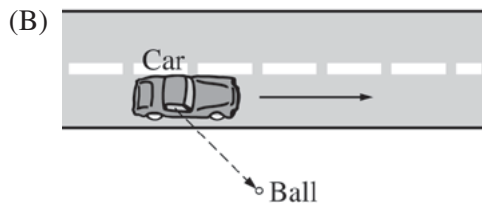
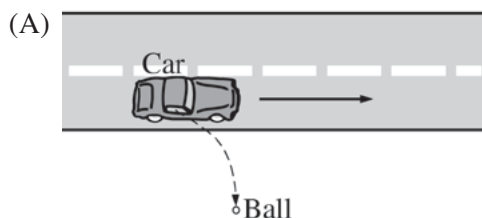

2. An object is thrown horizontally from the open window of a building. If the initial speed of the object is 20 m/s and it hits the ground 2.0 s later, from what height was it thrown? (Neglect air resistance and assume the ground is level.)

- (A) 4.9 m
(B) 9.8 m
(C) 10.0 m
(D) 19.6 m
(E) 39.2 m

3. A resistor in a circuit dissipates energy at a rate of 1 W. If the voltage across the resistor is doubled, what will be the new rate of energy dissipation?

- (A) 0.25 W
(B) 0.5 W
(C) 1 W
(D) 2 W
(E) 4 W

Unauthorized copying or reuse of
any part of this page is illegal.

GO ON TO THE NEXT PAGE.

SCRATCH WORK

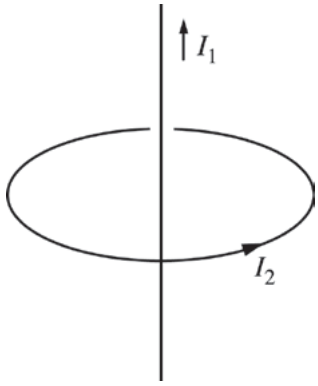

4. An infinitely long, straight wire carrying current I_1 passes through the center of a circular loop of wire carrying current I_2 , as shown above. The long wire is perpendicular to the plane of the loop. Which of the following describes the magnetic force on the loop?
- (A) Outward, along a radius of the loop.
 (B) Inward, along a radius of the loop.
 (C) Upward, along the axis of the loop.
 (D) Downward, along the axis of the loop.
 (E) There is no magnetic force on the loop.
5. De Broglie hypothesized that the linear momentum and wavelength of a free massive particle are related by which of the following constants?
- (A) Planck's constant
 (B) Boltzmann's constant
 (C) The Rydberg constant
 (D) The speed of light
 (E) Avogadro's number
6. An atom has filled $n = 1$ and $n = 2$ levels. How many electrons does the atom have?
- (A) 2
 (B) 4
 (C) 6
 (D) 8
 (E) 10
7. The root-mean-square speed of molecules of mass m in an ideal gas at temperature T is
- (A) 0
 (B) $\sqrt{\frac{2kT}{m}}$
 (C) $\sqrt{\frac{3kT}{m}}$
 (D) $\sqrt{\frac{8kT}{\pi m}}$
 (E) $\frac{kT}{m}$
8. The energy from electromagnetic waves in equilibrium in a cavity is used to melt ice. If the Kelvin temperature of the cavity is increased by a factor of two, the mass of ice that can be melted in a fixed amount of time is increased by a factor of
- (A) 2
 (B) 4
 (C) 8
 (D) 16
 (E) 32

SCRATCH WORK

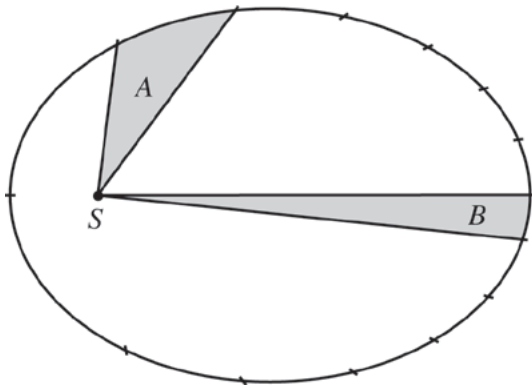

9. The figure above represents the orbit of a planet around a star, S , and the marks divide the orbit into 14 equal time intervals, $t = T/14$, where T is the orbital period. If the only force acting on the planet is Newtonian gravitation, then true statements about the situation include which of the following?

- I. Area $A =$ area B
- II. The star S is at one focus of an elliptically shaped orbit.
- III. $T^2 = Ca^3$, where a is the semimajor axis of the ellipse and C is a constant.

- (A) I only
 - (B) II only
 - (C) I and II only
 - (D) II and III only
 - (E) I, II, and III
10. A massless spring with force constant k launches a ball of mass m . In order for the ball to reach a speed v , by what displacement s should the spring be compressed?

- (A) $s = v\sqrt{\frac{k}{m}}$
- (B) $s = v\sqrt{\frac{m}{k}}$
- (C) $s = v\sqrt{\frac{2k}{m}}$
- (D) $s = v\frac{m}{k}$
- (E) $s = v^2\frac{m}{2k}$

11. A quantum mechanical harmonic oscillator has an angular frequency ω . The Schrödinger equation predicts that the ground state energy of the oscillator will be

- (A) $-\frac{1}{2}\hbar\omega$
- (B) 0
- (C) $\frac{1}{2}\hbar\omega$
- (D) $\hbar\omega$
- (E) $\frac{3}{2}\hbar\omega$

12. In the Bohr model of the hydrogen atom, the linear momentum of the electron at radius r_n is given by which of the following? (n is the principal quantum number.)

- (A) $n\hbar$
- (B) $nr_n\hbar$
- (C) $\frac{n\hbar}{r_n}$
- (D) $n^2r_n\hbar$
- (E) $\frac{n^2\hbar}{r_n}$

SCRATCH WORK

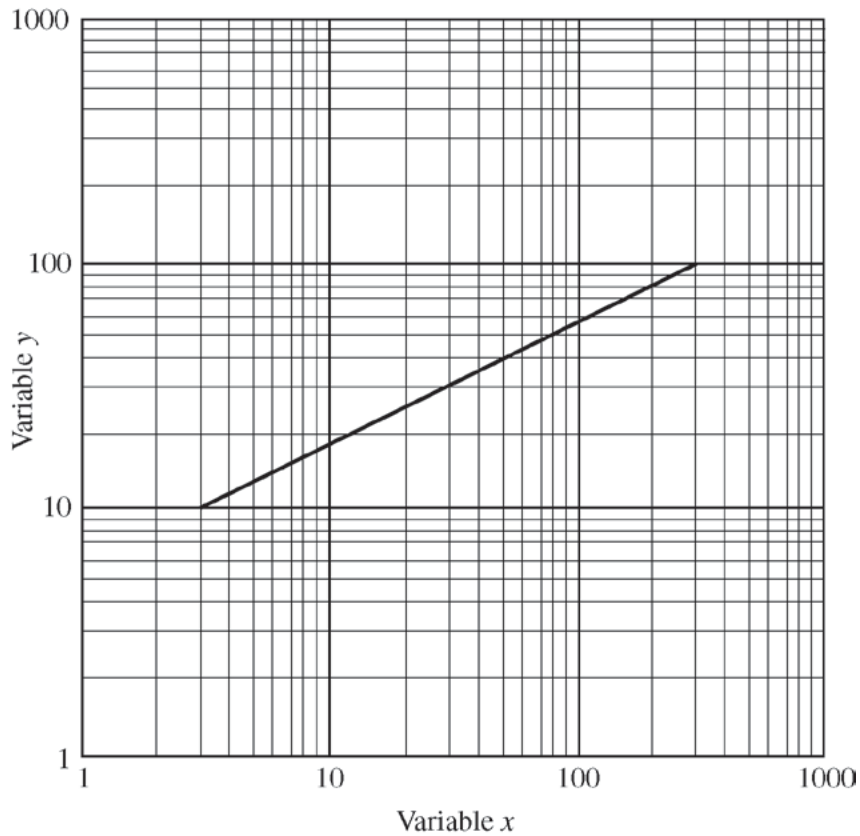

13. The figure above represents a log-log plot of variable y versus variable x . The origin represents the point $x = 1$ and $y = 1$. Which of the following gives the approximate functional relationship between y and x ?

- (A) $y = 6\sqrt{x}$
- (B) $y = \frac{1}{2}x + 6$
- (C) $y = 6x + 0.5$
- (D) $y = \frac{1}{6}x^2$
- (E) $y = 6x^2$

SCRATCH WORK

14. Two experimental techniques determine the mass of an object to be 11 ± 1 kg and 10 ± 2 kg. These two measurements can be combined to give a weighted average. The uncertainty of the weighted average is equal to which of the following?

- (A) $\frac{1}{2}$ kg
- (B) $\frac{2}{\sqrt{5}}$ kg
- (C) $\frac{2}{\sqrt{3}}$ kg
- (D) 2 kg
- (E) $\sqrt{5}$ kg

15. If the five lenses shown below are made of the same material, which lens has the shortest positive focal length?



SCRATCH WORK

16. Unpolarized light is incident on a pair of ideal linear polarizers whose transmission axes make an angle of 45° with each other. The transmitted light intensity through both polarizers is what percentage of the incident intensity?

- (A) 100%
- (B) 75%
- (C) 50%
- (D) 25%
- (E) 0%

17. A very long, thin, straight wire carries a uniform charge density of λ per unit length. Which of the following gives the magnitude of the electric field at a radial distance r from the wire?

- (A) $\frac{1}{2\pi\epsilon_0} \frac{\lambda}{r}$
- (B) $\frac{1}{2\pi\epsilon_0} \frac{r}{\lambda}$
- (C) $\frac{1}{2\pi\epsilon_0} \frac{\lambda}{r^2}$
- (D) $\frac{1}{4\pi\epsilon_0} \frac{\lambda^2}{r^2}$
- (E) $\frac{1}{4\pi\epsilon_0} \lambda \ln r$

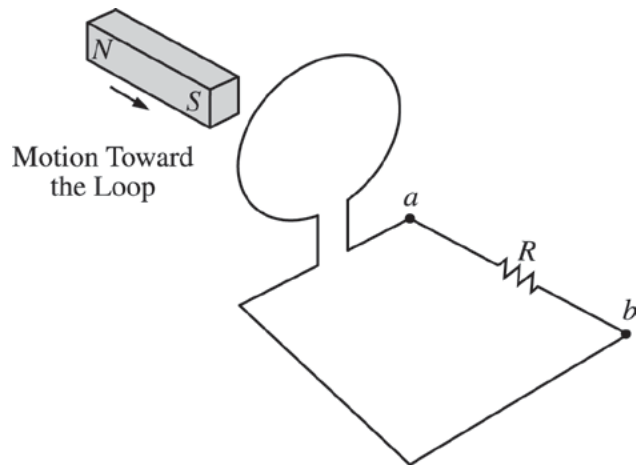

18. The bar magnet shown in the figure above is moved completely through the loop. Which of the following is a true statement about the direction of the current flow between the two points a and b in the circuit?

- (A) No current flows between a and b as the magnet passes through the loop.
- (B) Current flows from a to b as the magnet passes through the loop.
- (C) Current flows from b to a as the magnet passes through the loop.
- (D) Current flows from a to b as the magnet enters the loop and from b to a as the magnet leaves the loop.
- (E) Current flows from b to a as the magnet enters the loop and from a to b as the magnet leaves the loop.

SCRATCH WORK

19. The surface of the Sun has a temperature close to 6,000 K and it emits a blackbody (Planck) spectrum that reaches a maximum near 500 nm. For a body with a surface temperature close to 300 K, at what wavelength would the thermal spectrum reach a maximum?
- (A) 10 μm
 (B) 100 μm
 (C) 10 mm
 (D) 100 mm
 (E) 10 m
20. At the present time, the temperature of the universe (i.e., the microwave radiation background) is about 3 K. When the temperature was 12 K, typical objects in the universe, such as galaxies, were
- (A) one-quarter as distant as they are today
 (B) one-half as distant as they are today
 (C) separated by about the same distances as they are today
 (D) two times as distant as they are today
 (E) four times as distant as they are today
21. For an adiabatic process involving an ideal gas having volume V and temperature T , which of the following is constant? ($\gamma = C_p/C_v$)
- (A) TV
 (B) TV^γ
 (C) $TV^{\gamma-1}$
 (D) $T^\gamma V$
 (E) $T^\gamma V^{-1}$
22. An electron has total energy equal to four times its rest energy. The momentum of the electron is
- (A) $m_e c$
 (B) $\sqrt{2} m_e c$
 (C) $\sqrt{15} m_e c$
 (D) $4m_e c$
 (E) $2\sqrt{15} m_e c$
23. Two spaceships approach Earth with equal speeds, as measured by an observer on Earth, but from opposite directions. A meterstick on one spaceship is measured to be 60 cm long by an occupant of the other spaceship. What is the speed of each spaceship, as measured by the observer on Earth?
- (A) $0.4c$
 (B) $0.5c$
 (C) $0.6c$
 (D) $0.7c$
 (E) $0.8c$
24. A meter stick with a speed of $0.8c$ moves past an observer. In the observer's reference frame, how long does it take the stick to pass the observer?
- (A) 1.6 ns
 (B) 2.5 ns
 (C) 4.2 ns
 (D) 6.9 ns
 (E) 8.3 ns

SCRATCH WORK

25. Consider a set of wave functions $\psi_i(x)$. Which of the following conditions guarantees that the functions are normalized and mutually orthogonal? (The indices i and j take on the values in the set $\{1, 2, \dots, n\}$.)
- (A) $\psi_i^*(x)\psi_j(x) = 0$
- (B) $\psi_i^*(x)\psi_j(x) = 1$
- (C) $\int_{-\infty}^{\infty} \psi_i^*(x)\psi_j(x)dx = 0$
- (D) $\int_{-\infty}^{\infty} \psi_i^*(x)\psi_j(x)dx = 1$
- (E) $\int_{-\infty}^{\infty} \psi_i^*(x)\psi_j(x)dx = \delta_{ij}$
26. The normalized ground state wave function of hydrogen is $\psi_{100} = \frac{2}{(4\pi)^{1/2}a_0^{3/2}}e^{-r/a_0}$, where a_0 is the Bohr radius. What is the most likely distance that the electron is from the nucleus?
- (A) 0
- (B) $\frac{a_0}{2}$
- (C) $\frac{a_0}{\sqrt{2}}$
- (D) a_0
- (E) $2a_0$
27. The lifetime for the $2p \rightarrow 1s$ transition in hydrogen is 1.6×10^{-9} s. The natural line width for the radiation emitted during the transition is approximately
- (A) 100 Hz
- (B) 100 kHz
- (C) 100 MHz
- (D) 100 GHz
- (E) 100 THz
28. A spring of force constant k is stretched a certain distance. It takes twice as much work to stretch a second spring by half this distance. The force constant of the second spring is
- (A) k
- (B) $2k$
- (C) $4k$
- (D) $8k$
- (E) $16k$
29. On a frictionless surface, a block of mass M moving at speed v collides elastically with another block of the same mass that is initially at rest. After the collision, the first block moves at an angle θ to its initial direction and has a speed $v/2$. The second block's speed after the collision is
- (A) $\frac{\sqrt{3}}{4}v$
- (B) $\frac{v}{2}$
- (C) $\frac{\sqrt{3}}{2}v$
- (D) $\frac{\sqrt{5}}{2}v$
- (E) $v + \frac{v}{2}\cos\theta$

SCRATCH WORK

30. Which of the following gives Hamilton's canonical equation(s) of motion? (H is the Hamiltonian, q_i are the generalized coordinates, and p_i are the generalized momenta.)

(A) $q_i = \frac{\partial H}{\partial p_i}, \quad p_i = -\frac{\partial H}{\partial q_i}$

(B) $q_i = \frac{\partial H}{\partial \dot{q}_i}, \quad p_i = \frac{\partial H}{\partial \dot{p}_i}$

(C) $\dot{q}_i = \frac{\partial H}{\partial q_i}, \quad \dot{p}_i = -\frac{\partial H}{\partial p_i}$

(D) $\dot{q}_i = \frac{\partial H}{\partial p_i}, \quad \dot{p}_i = -\frac{\partial H}{\partial q_i}$

(E) $\frac{d}{dt} \left(\frac{\partial H}{\partial p_i} \right) - \frac{\partial H}{\partial q_i} = 0$

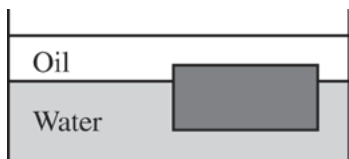

31. A layer of oil with density 800 kg/m^3 floats on top of a volume of water with density $1,000 \text{ kg/m}^3$. A block floats at the oil-water interface with $1/4$ of its volume in oil and $3/4$ of its volume in water, as shown in the figure above. What is the density of the block?

- (A) 200 kg/m^3
 (B) 850 kg/m^3
 (C) 950 kg/m^3
 (D) $1,050 \text{ kg/m}^3$
 (E) $1,800 \text{ kg/m}^3$

32. An incompressible fluid of density ρ flows through a horizontal pipe of radius r and then passes through a constriction of radius $r/2$. If the fluid has pressure P_0 and velocity v_0 before the constriction, the pressure in the constriction is

(A) $P_0 - \frac{15}{2} \rho v_0^2$

(B) $P_0 - \frac{3}{2} \rho v_0^2$

(C) $\frac{P_0}{4}$

(D) $P_0 + \frac{3}{2} \rho v_0^2$

(E) $P_0 + \frac{15}{2} \rho v_0^2$

33. A thermodynamic system, initially at absolute temperature T_1 , contains a mass m of water with specific heat capacity c . Heat is added until the temperature rises to T_2 . The change in entropy of the water is

(A) 0

(B) $T_2 - T_1$

(C) mcT_2

(D) $mc(T_2 - T_1)$

(E) $mc \ln \left(\frac{T_2}{T_1} \right)$

SCRATCH WORK

34. Heat Q is added to a monatomic ideal gas under conditions of constant volume, resulting in a temperature change ΔT . How much heat will be required to produce the same temperature change, if it is added under conditions of constant pressure?

- (A) $\frac{3}{5}Q$
- (B) Q
- (C) $\frac{5}{3}Q$
- (D) $2Q$
- (E) $\frac{10}{3}Q$

35. A heat pump is to extract heat from an outdoor environment at 7°C and heat the environment indoors to 27°C . For each 15,000 J of heat delivered indoors, the smallest amount of work that must be supplied to the heat pump is approximately

- (A) 500 J
- (B) 1,000 J
- (C) 1,100 J
- (D) 2,000 J
- (E) 2,200 J

SCRATCH WORK

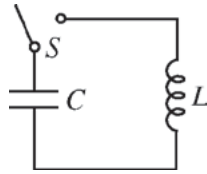

36. The capacitor in the circuit above is charged. If switch S is closed at time $t = 0$, which of the following represents the magnetic energy, U , in the inductor as a function of time? (Assume that the capacitor and inductor are ideal.)

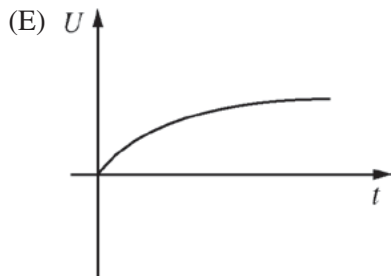
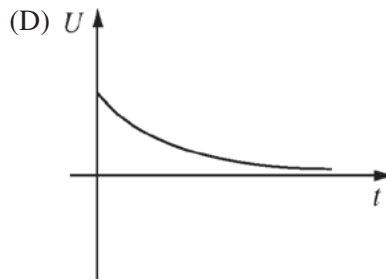
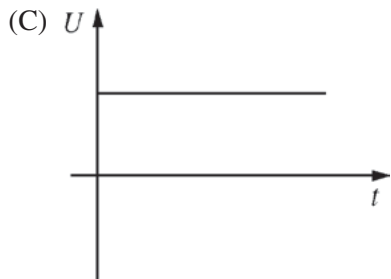
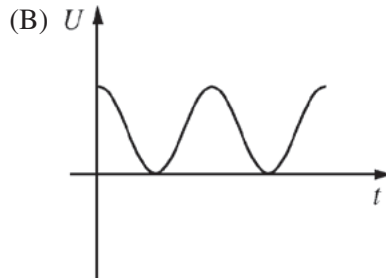
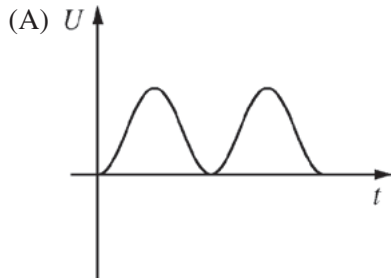

SCRATCH WORK

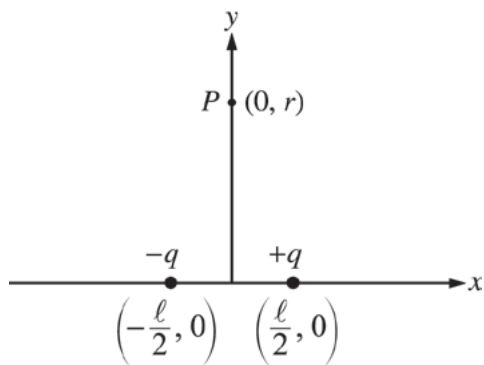

37. A pair of electric charges of equal magnitude q and opposite sign are separated by a distance ℓ , as shown in the figure above. Which of the following gives the approximate magnitude and direction of the electric field set up by the two charges at a point P on the y -axis, which is located a distance $r \gg \ell$ from the x -axis?

	<u>Magnitude</u>	<u>Direction</u>
(A)	$\frac{1}{4\pi\epsilon_0} \frac{2q}{r^2}$	+y
(B)	$\frac{1}{4\pi\epsilon_0} \frac{2q}{r^2}$	+x
(C)	$\frac{1}{4\pi\epsilon_0} \frac{2q}{r^2}$	-x
(D)	$\frac{1}{4\pi\epsilon_0} \frac{q\ell}{r^3}$	+x
(E)	$\frac{1}{4\pi\epsilon_0} \frac{q\ell}{r^3}$	-x

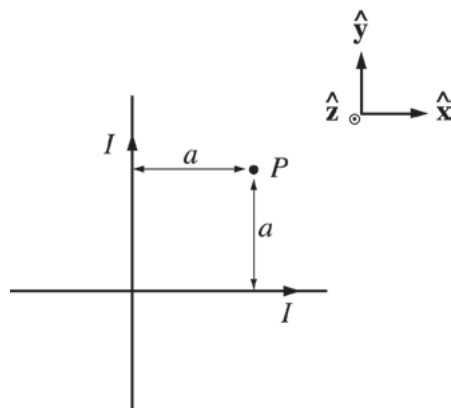

38. Consider two very long, straight, insulated wires oriented at right angles. The wires carry currents of equal magnitude I in the directions shown in the figure above. What is the net magnetic field at point P ?

- (A) $\frac{\mu_0 I}{2\pi a} (\hat{x} + \hat{y})$
 (B) $-\frac{\mu_0 I}{2\pi a} (\hat{x} + \hat{y})$
 (C) $\frac{\mu_0 I}{\pi a} \hat{z}$
 (D) $-\frac{\mu_0 I}{\pi a} \hat{z}$
 (E) $\mathbf{0}$

39. A beam of muons travels through the laboratory with speed $v = \frac{4}{5}c$. The lifetime of a muon in its rest frame is $\tau = 2.2 \times 10^{-6}$ s. The mean distance traveled by the muons in the laboratory frame is

- (A) 530 m
 (B) 660 m
 (C) 880 m
 (D) 1,100 m
 (E) 1,500 m

SCRATCH WORK

40. A particle of mass M decays from rest into two particles. One particle has mass m and the other particle is massless. The momentum of the massless particle is

(A) $\frac{(M^2 - m^2)c}{4M}$

(B) $\frac{(M^2 - m^2)c}{2M}$

(C) $\frac{(M^2 - m^2)c}{M}$

(D) $\frac{2(M^2 - m^2)c}{M}$

(E) $\frac{4(M^2 - m^2)c}{M}$

SCRATCH WORK

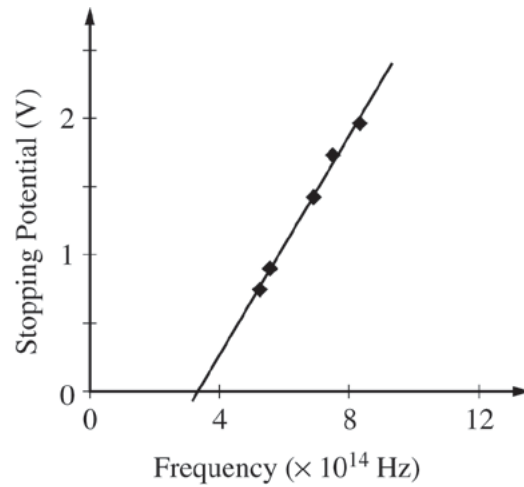

41. In an experimental observation of the photoelectric effect, the stopping potential was plotted versus the light frequency, as shown in the figure above. The best straight line was fitted to the experimental points. Which of the following gives the slope of the line? (The work function of the metal is ϕ .)

- (A) $\frac{h}{\phi}$
- (B) $\frac{h}{e}$
- (C) $\frac{e}{h}$
- (D) $\frac{e}{\phi}$
- (E) $\frac{\phi}{e}$

SCRATCH WORK

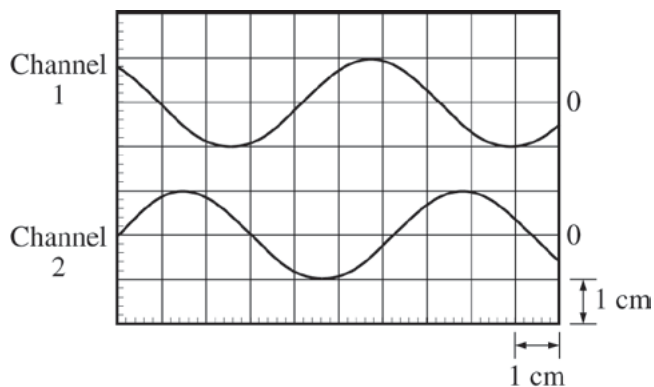

42. Two sinusoidal waveforms of the same frequency are displayed on an oscilloscope screen, as indicated above. The horizontal sweep of the oscilloscope is set to 100 ns/cm and the vertical gains of channels 1 and 2 are each set to 2 V/cm. The zero-voltage level of each channel is given at the right in the figure. The phase difference between the two waveforms is most nearly

- (A) 30°
- (B) 45°
- (C) 60°
- (D) 90°
- (E) 120°

43. In the diamond structure of elemental carbon, the nearest neighbors of each C atom lie at the corners of a

- (A) square
- (B) hexagon
- (C) cube
- (D) tetrahedron
- (E) octahedron

44. According to the BCS theory, the attraction between Cooper pairs in a superconductor is due to

- (A) the weak nuclear force
- (B) the strong nuclear force
- (C) vacuum polarization
- (D) interactions with the ionic lattice
- (E) the Casimir effect

45. During a hurricane, a 1,200 Hz warning siren on the town hall sounds. The wind is blowing at 55 m/s in a direction from the siren toward a person 1 km away. With what frequency does the sound wave reach the person? (The speed of sound in air is 330 m/s.)

- (A) 1,000 Hz
- (B) 1,030 Hz
- (C) 1,200 Hz
- (D) 1,400 Hz
- (E) 1,440 Hz

46. Sound waves moving at 350 m/s diffract out of a speaker enclosure with an opening that is a long rectangular slit 0.14 m across. At about what frequency will the sound first disappear at an angle of 45° from the normal to the speaker face?

- (A) 500 Hz
- (B) 1,750 Hz
- (C) 2,750 Hz
- (D) 3,500 Hz
- (E) 5,000 Hz

SCRATCH WORK

47. An organ pipe, closed at one end and open at the other, is designed to have a fundamental frequency of C (131 Hz). What is the frequency of the next higher harmonic for this pipe?
- (A) 44 Hz
 (B) 196 Hz
 (C) 262 Hz
 (D) 393 Hz
 (E) 524 Hz

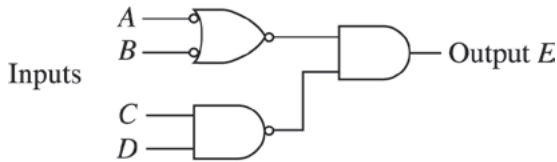

48. For the logic circuit shown above, which of the following Boolean statements gives the output E in terms of inputs A , B , C , and D ?
- (A) $E = \overline{A + B} + \overline{C \cdot D}$
 (B) $E = \overline{A + B} \cdot \overline{C \cdot D}$
 (C) $E = \overline{\overline{A + B} \cdot \overline{C \cdot D}}$
 (D) $E = \overline{A \cdot B \cdot C \cdot D}$
 (E) $E = \overline{\overline{A} \cdot \overline{B} \cdot \overline{C} \cdot \overline{D}}$
49. Which of the following lasers utilizes transitions that involve the energy levels of free atoms?
- (A) Diode laser
 (B) Dye laser
 (C) Free-electron laser
 (D) Gas laser
 (E) Solid-state laser

50. Which of the following expressions is proportional to the total energy for the levels of a one-electron Bohr atom? (m is the reduced mass, Z is the number of protons in the nucleus, $-e$ is the charge on the electron, and n is the principal quantum number.)

- (A) $\frac{mZe^2}{n}$
 (B) $\frac{mZe^2}{n^2}$
 (C) $\frac{mZ^2e^4}{n^2}$
 (D) $\frac{m^2Z^2e^2}{n^2}$
 (E) $\frac{m^2Z^2e^4}{n^2}$

51. True statements about the absorption and emission of energy by an atom include which of the following?
- I. An atom can only absorb photons of light that have certain specific energies.
 - II. An atom can emit photons of light of any energy.
 - III. At low temperature, the lines in the absorption spectrum of an atom coincide with the lines in its emission spectrum that represent transitions to the ground state.
- (A) I only
 (B) III only
 (C) I and II only
 (D) I and III only
 (E) I, II, and III

SCRATCH WORK

52. X rays of wavelength $\lambda = 0.250$ nm are incident on the face of a crystal at angle θ , measured from the crystal surface. The smallest angle that yields an intense reflected beam is $\theta = 14.5^\circ$. Which of the following gives the value of the interplanar spacing d ? ($\sin 14.5^\circ \approx 1/4$)
- (A) 0.125 nm
 (B) 0.250 nm
 (C) 0.500 nm
 (D) 0.625 nm
 (E) 0.750 nm
53. Astronomers observe two separate solar systems, each consisting of a planet orbiting a sun. The two orbits are circular and have the same radius R . It is determined that the planets have angular momenta of the same magnitude L about their suns, and that the orbital periods are in the ratio of three to one; i.e., $T_1 = 3T_2$. The ratio m_1/m_2 of the masses of the two planets is
- (A) 1
 (B) $\sqrt{3}$
 (C) 2
 (D) 3
 (E) 9
54. If the Sun were suddenly replaced by a black hole of the same mass, it would have a Schwarzschild radius of 3,000 m. What effect, if any, would this change have on the orbits of the planets?
- (A) The planets would move directly toward the Sun.
 (B) The planets would move in spiral orbits.
 (C) The planets would oscillate about their former elliptical orbits.
 (D) The orbits would precess much more rapidly.
 (E) The orbits would remain unchanged.
55. A distant galaxy is observed to have its hydrogen- β line shifted to a wavelength of 580 nm, away from the laboratory value of 434 nm. Which of the following gives the approximate velocity of recession of the distant galaxy? (Note: $\frac{580}{434} \approx \frac{4}{3}$)
- (A) $0.28c$
 (B) $0.53c$
 (C) $0.56c$
 (D) $0.75c$
 (E) $0.86c$
56. A small plane can fly at a speed of 200 km/h in still air. A 30 km/h wind is blowing from west to east. How much time is required for the plane to fly 500 km due north?
- (A) $\frac{50}{23}$ h
 (B) $\frac{50}{\sqrt{409}}$ h
 (C) $\frac{50}{20}$ h
 (D) $\frac{50}{\sqrt{391}}$ h
 (E) $\frac{50}{17}$ h

SCRATCH WORK

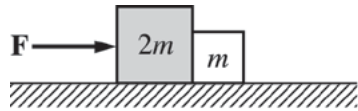

Figure 1

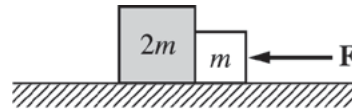
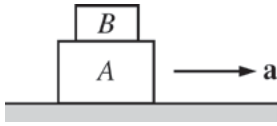

Figure 2

57. Each of the figures above shows blocks of mass $2m$ and m acted on by an external horizontal force \mathbf{F} . For each figure, which of the following statements about the magnitude of the force that one block exerts on the other (F_{12}) is correct? (Assume that the surface on which the blocks move is frictionless.)

<u>Figure 1</u>	<u>Figure 2</u>
(A) $F_{12} = \frac{F}{3}$	$F_{12} = \frac{F}{3}$
(B) $F_{12} = \frac{F}{3}$	$F_{12} = \frac{2F}{3}$
(C) $F_{12} = \frac{2F}{3}$	$F_{12} = \frac{F}{3}$
(D) $F_{12} = \frac{2F}{3}$	$F_{12} = \frac{2F}{3}$
(E) $F_{12} = F$	$F_{12} = F$

SCRATCH WORK



58. In the figure above, block A has mass $m_A = 25 \text{ kg}$ and block B has mass $m_B = 10 \text{ kg}$. Both blocks move with constant acceleration $a = 2 \text{ m/s}^2$ to the right, and the coefficient of static friction between the two blocks is $\mu_s = 0.8$. The static frictional force acting between the blocks is

- (A) 20 N
 (B) 50 N
 (C) 78 N
 (D) 196 N
 (E) 274 N

59. A simple pendulum of length l is suspended from the ceiling of an elevator that is accelerating upward with constant acceleration a . For small oscillations, the period, T , of the pendulum is

- (A) $T = 2\pi\sqrt{\frac{l}{g}}$
 (B) $T = 2\pi\sqrt{\frac{l}{g-a}}$
 (C) $T = 2\pi\sqrt{\frac{l}{g+a}}$
 (D) $T = 2\pi\sqrt{\frac{l}{g} \frac{a}{g+a}}$
 (E) $T = 2\pi\sqrt{\frac{l}{g} \frac{(g+a)}{a}}$

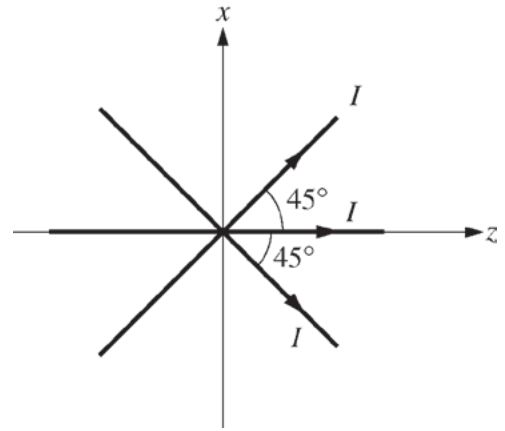

60. Three long, straight wires in the xz -plane, each carrying current I , cross at the origin of coordinates, as shown in the figure above. Let \hat{x} , \hat{y} , and \hat{z} denote the unit vectors in the x -, y -, and z -directions, respectively. The magnetic field \mathbf{B} as a function of x , with $y = 0$ and $z = 0$, is

- (A) $\mathbf{B} = \frac{3\mu_0 I}{2\pi x} \hat{x}$
 (B) $\mathbf{B} = \frac{3\mu_0 I}{2\pi x} \hat{y}$
 (C) $\mathbf{B} = \frac{\mu_0 I}{2\pi x} (1 + 2\sqrt{2}) \hat{y}$
 (D) $\mathbf{B} = \frac{\mu_0 I}{2\pi x} \hat{x}$
 (E) $\mathbf{B} = \frac{\mu_0 I}{2\pi x} \hat{y}$

SCRATCH WORK

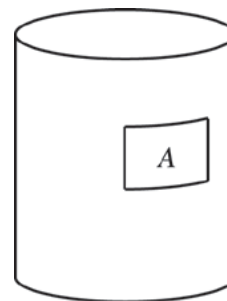
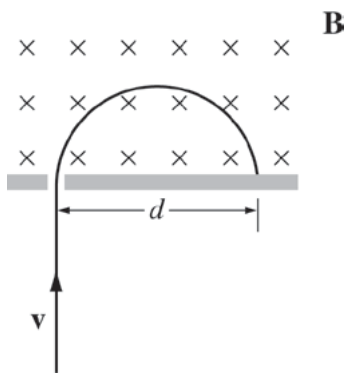

61. A particle with mass m and charge q , moving with a velocity \mathbf{v} , enters a region of uniform magnetic field \mathbf{B} , as shown in the figure above. The particle strikes the wall at a distance d from the entrance slit. If the particle's velocity stays the same but its charge-to-mass ratio is doubled, at what distance from the entrance slit will the particle strike the wall?

- (A) $2d$
- (B) $\sqrt{2}d$
- (C) d
- (D) $\frac{1}{\sqrt{2}}d$
- (E) $\frac{1}{2}d$

62. Consider the closed cylindrical Gaussian surface above. Suppose that the net charge enclosed within this surface is $+1 \times 10^{-9}$ C and the electric flux out through the portion of the surface marked A is -100 N·m²/C. The flux through the rest of the surface is most nearly given by which of the following?

- (A) -100 N·m²/C
- (B) 0 N·m²/C
- (C) 10 N·m²/C
- (D) 100 N·m²/C
- (E) 200 N·m²/C

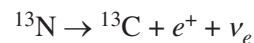

63. The nuclear decay above is an example of a process induced by the

- (A) Mössbauer effect
- (B) Casimir effect
- (C) photoelectric effect
- (D) weak interaction
- (E) strong interaction

SCRATCH WORK

64. Consider a single electron atom with orbital angular momentum $L = \sqrt{2}\hbar$. Which of the following gives the possible values of a measurement of L_z , the z -component of L ?
- (A) 0
 (B) $0, \hbar$
 (C) $0, \hbar, 2\hbar$
 (D) $-\hbar, 0, \hbar$
 (E) $-2\hbar, -\hbar, 0, \hbar, 2\hbar$
65. Characteristics of the quantum harmonic oscillator include which of the following?
- I. A spectrum of evenly spaced energy states
 II. A potential energy function that is linear in the position coordinate
 III. A ground state that is characterized by zero kinetic energy
 IV. A nonzero probability of finding the oscillator outside the classical turning points
- (A) I only
 (B) IV only
 (C) I and IV only
 (D) II and III only
 (E) I, II, III, and IV

66. A muon can be considered to be a heavy electron with a mass $m_\mu = 207m_e$. Imagine replacing the electron in a hydrogen atom with a muon. What are the energy levels E_n for this new form of hydrogen in terms of the binding energy of ordinary hydrogen E_0 , the mass of the proton m_p , and the principal quantum number n ?

(A) $E_n = \frac{-E_0}{n^2} \left(\frac{m_\mu}{m_e} \right)$

(B) $E_n = \frac{-E_0}{n^2} \left(\frac{m_e}{m_\mu} \right)$

(C) $E_n = \frac{-E_0}{n^2} \left(\frac{(m_p + m_e)}{(m_p + m_\mu)} \right)$

(D) $E_n = \frac{-E_0}{n^2} \left(\frac{m_\mu(m_p + m_e)}{m_e(m_p + m_\mu)} \right)$

(E) $E_n = \frac{-E_0}{n^2} \left(\frac{m_e(m_p + m_\mu)}{m_\mu(m_p + m_e)} \right)$

SCRATCH WORK

67. A large, parallel-plate capacitor consists of two square plates that measure 0.5 m on each side. A charging current of 9 A is applied to the capacitor. Which of the following gives the approximate rate of change of the electric field between the plates?

- (A) $2 \frac{\text{V}}{\text{m}\cdot\text{s}}$
- (B) $40 \frac{\text{V}}{\text{m}\cdot\text{s}}$
- (C) $1 \times 10^{12} \frac{\text{V}}{\text{m}\cdot\text{s}}$
- (D) $4 \times 10^{12} \frac{\text{V}}{\text{m}\cdot\text{s}}$
- (E) $2 \times 10^{13} \frac{\text{V}}{\text{m}\cdot\text{s}}$

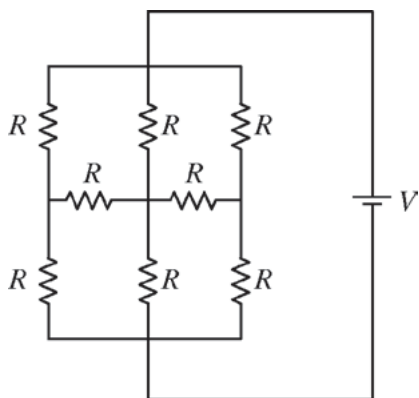

68. The circuit shown in the figure above consists of eight resistors, each with resistance R , and a battery with terminal voltage V and negligible internal resistance. What is the current flowing through the battery?

- (A) $\frac{1}{3} \frac{V}{R}$
- (B) $\frac{1}{2} \frac{V}{R}$
- (C) $\frac{V}{R}$
- (D) $\frac{3}{2} \frac{V}{R}$
- (E) $3 \frac{V}{R}$

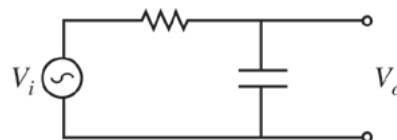

69. In the AC circuit above, V_i is the amplitude of the input voltage and V_o is the amplitude of the output voltage. If the angular frequency ω of the input voltage is varied, which of the following gives the ratio $V_o/V_i = G$ as a function of ω ?

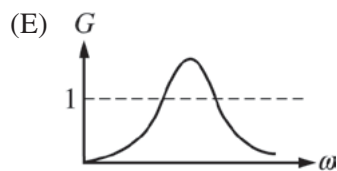
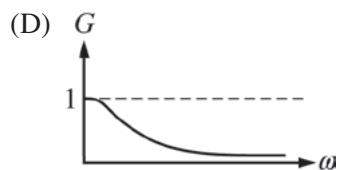
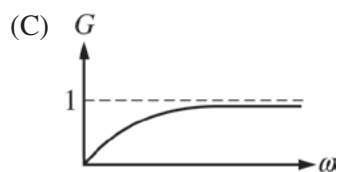
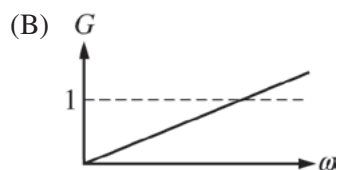
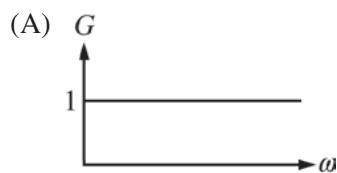

SCRATCH WORK

70. A wire loop that encloses an area of 10 cm^2 has a resistance of 5Ω . The loop is placed in a magnetic field of 0.5 T with its plane perpendicular to the field. The loop is suddenly removed from the field. How much charge flows past a given point in the wire?
- (A) 10^{-4} C
 (B) 10^{-3} C
 (C) 10^{-2} C
 (D) 10^{-1} C
 (E) 1 C

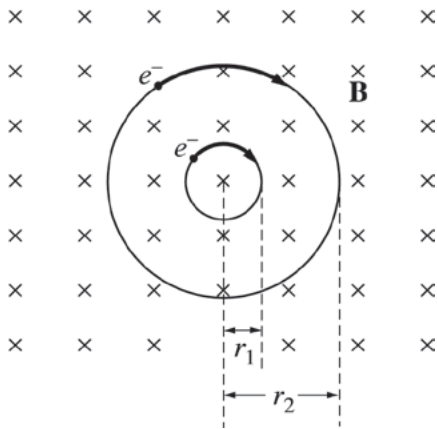

71. Two nonrelativistic electrons move in circles under the influence of a uniform magnetic field \mathbf{B} , as shown in the figure above. The ratio r_1/r_2 of the orbital radii is equal to $1/3$. Which of the following is equal to the ratio v_1/v_2 of the speeds?
- (A) $1/9$
 (B) $1/3$
 (C) 1
 (D) 3
 (E) 9

72. Which of the following statements about bosons and/or fermions is true?
- (A) Bosons have symmetric wave functions and obey the Pauli exclusion principle.
 (B) Bosons have antisymmetric wave functions and do not obey the Pauli exclusion principle.
 (C) Fermions have symmetric wave functions and obey the Pauli exclusion principle.
 (D) Fermions have antisymmetric wave functions and obey the Pauli exclusion principle.
 (E) Bosons and fermions obey the Pauli exclusion principle.

73. The discovery of the J/ψ particle was especially significant because it provided evidence for which of the following?
- (A) Parity violation in weak interactions
 (B) Massive neutrinos
 (C) Higgs bosons
 (D) Charmed quarks
 (E) Strange quarks

SCRATCH WORK

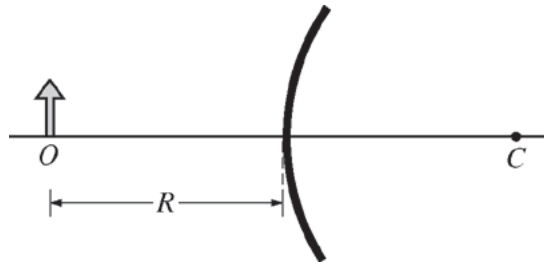

74. The figure above shows an object O placed at a distance R to the left of a convex spherical mirror that has a radius of curvature R . Point C is the center of curvature of the mirror. The image formed by the mirror is at
- (A) infinity
 - (B) a distance R to the left of the mirror and inverted
 - (C) a distance R to the right of the mirror and upright
 - (D) a distance $\frac{R}{3}$ to the left of the mirror and inverted
 - (E) a distance $\frac{R}{3}$ to the right of the mirror and upright

SCRATCH WORK

75. A uniform thin film of soapy water with index of refraction $n = 1.33$ is viewed in air via reflected light. The film appears dark for long wavelengths and first appears bright for $\lambda = 540$ nm. What is the next shorter wavelength at which the film will appear bright on reflection?
- (A) 135 nm
 (B) 180 nm
 (C) 270 nm
 (D) 320 nm
 (E) 405 nm

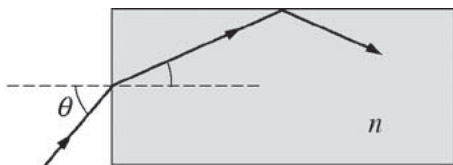

76. A model of an optical fiber is shown in the figure above. The optical fiber has an index of refraction, n , and is surrounded by free space. What angles of incidence, θ , will result in the light staying in the optical fiber?
- (A) $\theta > \sin^{-1}(\sqrt{n^2 - 1})$
 (B) $\theta < \sin^{-1}(\sqrt{n^2 - 1})$
 (C) $\theta > \sin^{-1}(\sqrt{n^2 + 1})$
 (D) $\theta < \sin^{-1}(\sqrt{n^2 + 1})$
 (E) $\sin^{-1}(\sqrt{n^2 - 1}) < \theta < \sin^{-1}(\sqrt{n^2 + 1})$

77. A gas at temperature T is composed of molecules of mass m . Which of the following describes how the average time between intermolecular collisions varies with m ?
- (A) It is proportional to $\frac{1}{m}$.
 (B) It is proportional to $\sqrt[4]{m}$.
 (C) It is proportional to \sqrt{m} .
 (D) It is proportional to m .
 (E) It is proportional to m^2 .

78. A particle can occupy two possible states with energies E_1 and E_2 , where $E_2 > E_1$. At temperature T , the probability of finding the particle in state 2 is given by which of the following?

- (A) $\frac{e^{-E_1/kT}}{e^{-E_1/kT} + e^{-E_2/kT}}$
 (B) $\frac{e^{-E_2/kT}}{e^{-E_1/kT} + e^{-E_2/kT}}$
 (C) $\frac{e^{-(E_1+E_2)/kT}}{e^{-E_1/kT} + e^{-E_2/kT}}$
 (D) $\frac{e^{-E_1/kT} + e^{-E_2/kT}}{e^{-E_2/kT}}$
 (E) $\frac{e^{-E_1/kT} + e^{-E_2/kT}}{e^{-E_1/kT}}$

SCRATCH WORK

$$\left(p + \frac{a}{V^2}\right)(V - b) = RT$$

79. Consider 1 mole of a real gas that obeys the van der Waals equation of state shown above. If the gas undergoes an isothermal expansion at temperature T_0 from volume V_1 to volume V_2 , which of the following gives the work done by the gas?

(A) 0

(B) $RT_0 \ln\left(\frac{V_2}{V_1}\right)$

(C) $RT_0 \ln\left(\frac{V_2 - b}{V_1 - b}\right)$

(D) $RT_0 \ln\left(\frac{V_2 - b}{V_1 - b}\right) + a\left(\frac{1}{V_2} - \frac{1}{V_1}\right)$

(E) $RT_0\left(\frac{1}{(V_2 - b)^2} - \frac{1}{(V_1 - b)^2}\right) + a\left(\frac{1}{V_2^3} - \frac{1}{V_1^3}\right)$

80. A 1 kg block attached to a spring vibrates with a frequency of 1 Hz on a frictionless horizontal table. Two springs identical to the original spring are attached in parallel to an 8 kg block placed on the same table. Which of the following gives the frequency of vibration of the 8 kg block?

(A) $\frac{1}{4}$ Hz

(B) $\frac{1}{2\sqrt{2}}$ Hz

(C) $\frac{1}{2}$ Hz

(D) 1 Hz

(E) 2 Hz

SCRATCH WORK

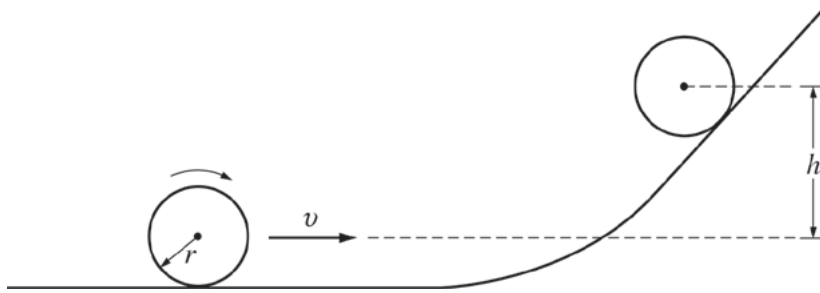

81. A uniform disk with a mass of m and a radius of r rolls without slipping along a horizontal surface and ramp, as shown above. The disk has an initial velocity of v . What is the maximum height h to which the center of mass of the disk rises?

(A) $h = \frac{v^2}{2g}$

(B) $h = \frac{3v^2}{4g}$

(C) $h = \frac{v^2}{g}$

(D) $h = \frac{3v^2}{2g}$

(E) $h = \frac{2v^2}{g}$

82. A mass, m , is attached to a massless spring fixed at one end. The mass is confined to move in a horizontal plane, and its position is given by the polar coordinates r and θ . Both r and θ can vary. If the relaxed length of the spring is s and the force constant is k , what is the Lagrangian, L , for the system?

(A) $L = \frac{1}{2}m\dot{r}^2 + \frac{1}{2}mr^2\dot{\theta}^2 - \frac{1}{2}k(r \cos \theta - s)^2$

(B) $L = \frac{1}{2}m\dot{r}^2 + \frac{1}{2}mr^2\dot{\theta}^2 - \frac{1}{2}k(r \sin \theta - s)^2$

(C) $L = \frac{1}{2}m\dot{r}^2 + \frac{1}{2}mr^2\dot{\theta}^2 + \frac{1}{2}k(r - s)^2$

(D) $L = \frac{1}{2}m\dot{r}^2 + \frac{1}{2}mr^2\dot{\theta}^2 - \frac{1}{2}k(r - s)^2$

(E) $L = -\frac{1}{2}m\dot{r}^2 + \frac{1}{2}mr^2\dot{\theta}^2 + \frac{1}{2}k(r - s)^2$

SCRATCH WORK

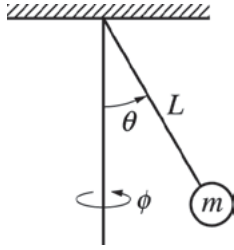

83. A mass m attached to the end of a massless rod of length L is free to swing below the plane of support, as shown in the figure above. The Hamiltonian for this system is given by

$$H = \frac{p_\theta^2}{2mL^2} + \frac{p_\phi^2}{2mL^2 \sin^2 \theta} - mgL \cos \theta,$$

where θ and ϕ are defined as shown in the figure. On the basis of Hamilton's equations of motion, the generalized coordinate or momentum that is a constant in time is

- (A) θ
- (B) ϕ
- (C) $\dot{\theta}$
- (D) p_θ
- (E) p_ϕ

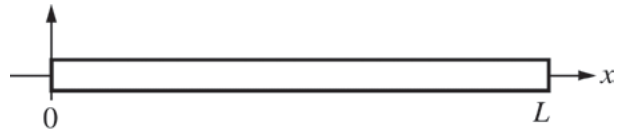

84. A rod of length L and mass M is placed along the x -axis with one end at the origin, as shown in the figure above. The rod has linear mass density $\lambda = \frac{2M}{L^2}x$, where x is the distance from the origin. Which of the following gives the x -coordinate of the rod's center of mass?

- (A) $\frac{1}{12}L$
- (B) $\frac{1}{4}L$
- (C) $\frac{1}{3}L$
- (D) $\frac{1}{2}L$
- (E) $\frac{2}{3}L$

SCRATCH WORK

85. A particle is in an infinite square well potential with walls at $x = 0$ and $x = L$. If the particle is in the state $\psi(x) = A \sin\left(\frac{3\pi x}{L}\right)$, where A is a constant, what is the probability that the particle is between $x = \frac{1}{3}L$ and $x = \frac{2}{3}L$?

- (A) 0
- (B) $\frac{1}{3}$
- (C) $\frac{1}{\sqrt{3}}$
- (D) $\frac{2}{3}$
- (E) 1

86. Which of the following are the eigenvalues of the Hermitian matrix $\begin{pmatrix} 2 & i \\ -i & 2 \end{pmatrix}$?

- (A) 1, 0
- (B) 1, 3
- (C) 2, 2
- (D) i , $-i$
- (E) $1 + i$, $1 - i$

SCRATCH WORK

$$\sigma_x = \begin{pmatrix} 0 & 1 \\ 1 & 0 \end{pmatrix}, \quad \sigma_y = \begin{pmatrix} 0 & -i \\ i & 0 \end{pmatrix}, \quad \sigma_z = \begin{pmatrix} 1 & 0 \\ 0 & -1 \end{pmatrix}, \quad I = \begin{pmatrix} 1 & 0 \\ 0 & 1 \end{pmatrix}$$

87. Consider the Pauli spin matrices σ_x , σ_y , and σ_z and the identity matrix I given above. The commutator $[\sigma_x, \sigma_y] \equiv \sigma_x\sigma_y - \sigma_y\sigma_x$ is equal to which of the following?

- (A) I
- (B) $2i\sigma_x$
- (C) $2i\sigma_y$
- (D) $2i\sigma_z$
- (E) 0

SCRATCH WORK

88. A spin- $\frac{1}{2}$ particle is in a state described by the spinor

$$\chi = A \begin{pmatrix} 1+i \\ 2 \end{pmatrix},$$

where A is a normalization constant. The probability of finding the particle with spin projection $S_z = -\frac{1}{2}\hbar$ is

- (A) $\frac{1}{6}$
- (B) $\frac{1}{3}$
- (C) $\frac{1}{2}$
- (D) $\frac{2}{3}$
- (E) 1

SCRATCH WORK

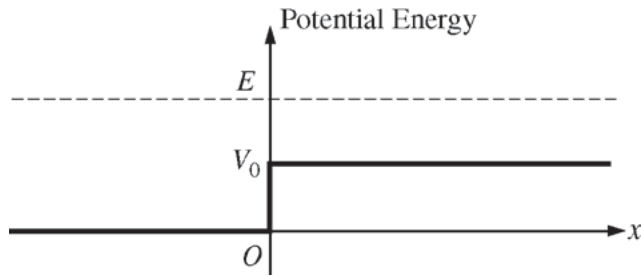

89. An electron with total energy E in the region $x < 0$ is moving in the $+x$ -direction. It encounters a step potential at $x = 0$. The wave function for $x \leq 0$ is given by

$$\psi = Ae^{ik_1x} + Be^{-ik_1x}, \text{ where } k_1 = \sqrt{\frac{2mE}{\hbar^2}};$$

and the wave function for $x > 0$ is given by

$$\psi = Ce^{ik_2x}, \text{ where } k_2 = \sqrt{\frac{2m(E - V_0)}{\hbar^2}}.$$

Which of the following gives the reflection coefficient for the system?

- (A) $R = 0$
- (B) $R = 1$
- (C) $R = \frac{k_2}{k_1}$
- (D) $R = \left(\frac{k_1 - k_2}{k_1 + k_2}\right)^2$
- (E) $R = \frac{4k_1k_2}{(k_1 + k_2)^2}$

SCRATCH WORK

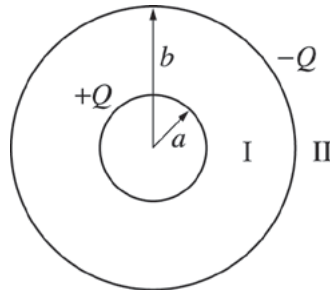

90. Two thin, concentric, spherical conducting shells are arranged as shown in the figure above. The inner shell has radius a , charge $+Q$, and is at zero electric potential. The outer shell has radius b and charge $-Q$. If r is the radial distance from the center of the spheres, what is the electric potential in region I ($a < r < b$) and in region II ($r > b$)?

	<u>Region I</u>	<u>Region II</u>
(A)	$\frac{Q}{4\pi\epsilon_0} \frac{1}{r}$	0
(B)	$\frac{Q}{4\pi\epsilon_0} \left(\frac{1}{r} - \frac{1}{a} \right)$	0
(C)	$\frac{Q}{4\pi\epsilon_0} \left(\frac{1}{r} - \frac{1}{b} \right)$	$-\frac{Q}{4\pi\epsilon_0} \frac{1}{r}$
(D)	$\frac{Q}{4\pi\epsilon_0} \left(\frac{1}{r} - \frac{1}{a} \right)$	$\frac{Q}{4\pi\epsilon_0} \left(\frac{1}{b} - \frac{1}{a} \right)$
(E)	$\frac{Q}{4\pi\epsilon_0} \left(\frac{1}{r} - \frac{1}{b} \right)$	$\frac{Q}{4\pi\epsilon_0} \left(\frac{1}{a} - \frac{1}{b} \right)$

91. In static electromagnetism, let \mathbf{E} , \mathbf{B} , \mathbf{J} , and ρ be the electric field, magnetic field, current density, and charge density, respectively. Which of the following conditions allows the electric field to be written in the form $\mathbf{E} = -\nabla\phi$, where ϕ is the electrostatic potential?
- (A) $\nabla \cdot \mathbf{J} = 0$
 (B) $\nabla \cdot \mathbf{E} = \rho/\epsilon_0$
 (C) $\nabla \times \mathbf{E} = \mathbf{0}$
 (D) $\nabla \times \mathbf{B} = \mu_0\mathbf{J}$
 (E) $\nabla \cdot \mathbf{B} = 0$

SCRATCH WORK

92. A long, straight, hollow cylindrical wire with an inner radius R and an outer radius $2R$ carries a uniform current density. Which of the following graphs best represents the magnitude of the magnetic field as a function of the distance from the center of the wire?

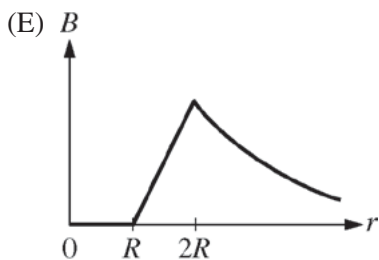
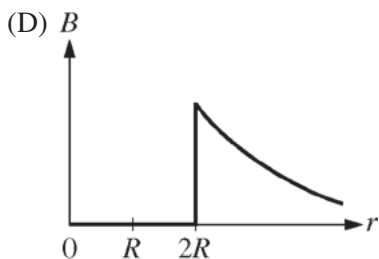
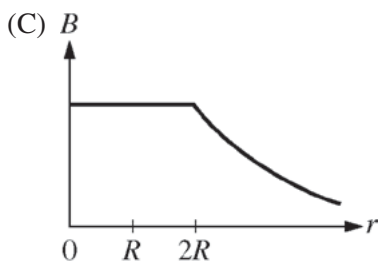
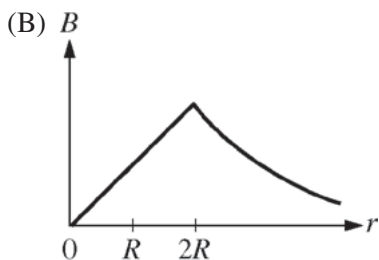
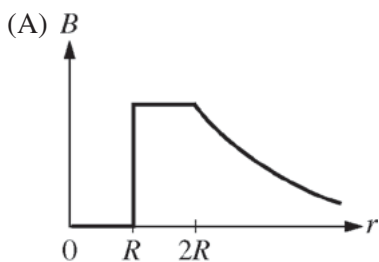

93. A parallel-plate capacitor has plate separation d . The space between the plates is empty. A battery supplying voltage V_0 is connected across the capacitor, resulting in electromagnetic energy U_0 stored in the capacitor. A dielectric, of dielectric constant κ , is inserted so that it just fills the space between the plates. If the battery is still connected, what are the electric field E and the energy U stored in the dielectric, in terms of V_0 and U_0 ?

- | | $\frac{E}{d}$ | $\frac{U}{U_0}$ |
|-----|------------------------|-----------------|
| (A) | $\frac{V_0}{d}$ | U_0 |
| (B) | $\frac{V_0}{d}$ | κU_0 |
| (C) | $\frac{V_0}{d}$ | $\kappa^2 U_0$ |
| (D) | $\frac{V_0}{\kappa d}$ | U_0 |
| (E) | $\frac{V_0}{\kappa d}$ | κU_0 |

94. An observer O at rest midway between two sources of light at $x = 0$ and $x = 10$ m observes the two sources to flash simultaneously. According to a second observer O' , moving at a constant speed parallel to the x -axis, one source of light flashes 13 ns before the other. Which of the following gives the speed of O' relative to O ?
- (A) $0.13c$
 (B) $0.15c$
 (C) $0.36c$
 (D) $0.53c$
 (E) $0.62c$

SCRATCH WORK

95. Let $\hat{\mathbf{J}}$ be a quantum mechanical angular momentum operator. The commutator $[\hat{J}_x \hat{J}_y, \hat{J}_x]$ is equivalent to which of the following?
- (A) 0
 (B) $i\hbar \hat{J}_z$
 (C) $i\hbar \hat{J}_z \hat{J}_x$
 (D) $-i\hbar \hat{J}_x \hat{J}_z$
 (E) $i\hbar \hat{J}_x \hat{J}_y$
96. Which of the following ions CANNOT be used as a dopant in germanium to make an *n*-type semiconductor?
- (A) As
 (B) P
 (C) Sb
 (D) B
 (E) N
97. In the Compton effect, a photon with energy E scatters through a 90° angle from a stationary electron of mass m . The energy of the scattered photon is
- (A) E
 (B) $\frac{E}{2}$
 (C) $\frac{E^2}{mc^2}$
 (D) $\frac{E^2}{E + mc^2}$
 (E) $\frac{E \cdot mc^2}{E + mc^2}$
98. Which of the following is the principal decay mode of the positive muon μ^+ ?
- (A) $\mu^+ \rightarrow e^+ + \nu_e$
 (B) $\mu^+ \rightarrow p + \nu_\mu$
 (C) $\mu^+ \rightarrow n + e^+ + \nu_e$
 (D) $\mu^+ \rightarrow e^+ + \nu_e + \bar{\nu}_\mu$
 (E) $\mu^+ \rightarrow \pi^+ + \bar{\nu}_e + \nu_\mu$

SCRATCH WORK

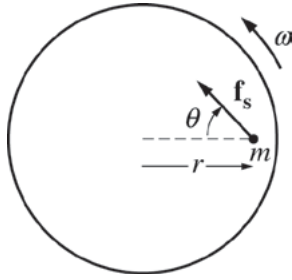

99. A small particle of mass m is at rest on a horizontal circular platform that is free to rotate about a vertical axis through its center. The particle is located at a radius r from the axis, as shown in the figure above. The platform begins to rotate with constant angular acceleration α . Because of friction between the particle and the platform, the particle remains at rest with respect to the platform. When the platform has reached angular speed ω , the angle θ between the static frictional force \mathbf{f}_s and the inward radial direction is given by which of the following?

- (A) $\theta = \frac{\omega^2 r}{g}$
- (B) $\theta = \frac{\omega^2}{\alpha}$
- (C) $\theta = \frac{\alpha}{\omega^2}$
- (D) $\theta = \tan^{-1}\left(\frac{\omega^2}{\alpha}\right)$
- (E) $\theta = \tan^{-1}\left(\frac{\alpha}{\omega^2}\right)$

SCRATCH WORK

100. The partition function Z in statistical mechanics can be written as

$$Z = \sum_r e^{-E_r/kT},$$

where the index r ranges over all possible microstates of a system and E_r is the energy of microstate r . For a single quantum mechanical harmonic oscillator with energies

$$E_n = \left(n + \frac{1}{2}\right)\hbar\omega, \text{ where } n = 0, 1, 2, \dots,$$

the partition function Z is given by which of the following?

- (A) $Z = e^{-\frac{1}{2}\hbar\omega/kT}$
- (B) $Z = e^{\frac{1}{2}\hbar\omega/kT}$
- (C) $Z = e^{\frac{1}{2}\hbar\omega/kT} - 1$
- (D) $Z = e^{\frac{1}{2}\hbar\omega/kT} + 1$
- (E) $Z = \frac{e^{\frac{1}{2}\hbar\omega/kT}}{e^{\hbar\omega/kT} - 1}$

If you finish before time is called, you may check your work on this test.

SCRATCH WORK

NO TEST MATERIAL ON THIS PAGE

NO TEST MATERIAL ON THIS PAGE

I

NOTE: To ensure prompt processing of test results, it is important that you fill in the blanks exactly as directed.

SUBJECT TEST

A. Print and sign your full name in this box:

PRINT: _____ (LAST) (FIRST) (MIDDLE)
SIGN: _____

Copy this code in box 6 on your answer sheet. Then fill in the corresponding ovals exactly as shown.

6. TITLE CODE				
7	7	9	1	7
⓪	⓪	⓪	●	⓪
①	①	①	①	①
②	②	②	②	②
③	③	③	③	③
④	④	④	④	④
⑤	⑤	⑤	⑤	⑤
⑥	⑥	⑥	⑥	⑥
●	●	⑦	⑦	●
⑧	⑧	⑧	⑧	⑧
⑨	⑨	●	⑨	⑨

Copy the Test Name and Form Code in box 7 on your answer sheet.

TEST NAME Physics

FORM CODE GR0877

GRADUATE RECORD EXAMINATIONS SUBJECT TEST

B. The Subject Tests are intended to measure your achievement in a specialized field of study. Most of the questions are concerned with subject matter that is probably familiar to you, but some of the questions may refer to areas that you have not studied.

Your score will be determined by subtracting one-fourth the number of incorrect answers from the number of correct answers. Questions for which you mark no answer or more than one answer are not counted in scoring. If you have some knowledge of a question and are able to rule out one or more of the answer choices as incorrect, your chances of selecting the correct answer are improved, and answering such questions will likely improve your score. It is unlikely that pure guessing will raise your score; it may lower your score.

You are advised to use your time effectively and to work as rapidly as you can without losing accuracy. Do not spend too much time on questions that are too difficult for you. Go on to the other questions and come back to the difficult ones later if you can.

YOU MUST INDICATE ALL YOUR ANSWERS ON THE SEPARATE ANSWER SHEET. No credit will be given for anything written in this examination book, but you may write in the book as much as you wish to work out your answers. After you have decided on your response to a question, fill in the corresponding oval on the answer sheet. **BE SURE THAT EACH MARK IS DARK AND COMPLETELY FILLS THE OVAL.** Mark only one answer to each question. No credit will be given for multiple answers. Erase all stray marks. If you change an answer, be sure that all previous marks are erased completely. Incomplete erasures may be read as intended answers. Do not be concerned that the answer sheet provides spaces for more answers than there are questions in the test.

Example:

What city is the capital of France?

- (A) Rome
- (B) Paris
- (C) London
- (D) Cairo
- (E) Oslo

Sample Answer

(A) ● (C) (D) (E)

(A) X (C) (D) (E)

(A) ✓ (C) (D) (E)

(A) ● (C) (D) (E)

(A) F (C) (D) (E)

**CORRECT ANSWER
PROPERLY MARKED**

IMPROPER MARKS

DO NOT OPEN YOUR TEST BOOK UNTIL YOU ARE TOLD TO DO SO.



Educational Testing Service
Princeton, New Jersey 08541

Scoring Your Subject Test

The Physics Test scores are reported on a 200 to 990 score scale in ten-point increments. The actual range of scores is smaller, and it varies from edition to edition because different editions are not of precisely the same difficulty. However, this variation in score range is usually small and should be taken into account mainly when comparing two very high scores. In general, differences between scores at the 99th percentile should be ignored. **The score conversion table on page 91 shows the score range for this edition of the test only.**

The worksheet on page 90 lists the correct answers to the questions. Columns are provided for you to mark whether you chose the correct (C) answer or an incorrect (I) answer to each question. Draw a line across any question you omitted, because it is not counted in the scoring. At the bottom of the page,

enter the total number correct and the total number incorrect. Divide the total incorrect by 4 and subtract the resulting number from the total correct. Then round the result to the nearest whole number. This will give you your raw total score. Use the total score conversion table to find the scaled total score that corresponds to your raw total score.

Example: Suppose you chose the correct answers to 44 questions and incorrect answers to 30. Dividing 30 by 4 yields 7.5. Subtracting 7.5 from 44 equals 36.5, which is rounded to 37. The raw score of 37 corresponds to a scaled score of 630.

Worksheet for the Physics Test, Form GR0877
Answer Key and Percentage* of Examinees
Answering Each Question Correctly

QUESTION		P +	TOTAL		QUESTION		P +	TOTAL	
Number	Answer		C	I	Number	Answer		C	I
1	B	72			51	D	69		
2	D	88			52	C	56		
3	E	60			53	D	50		
4	E	72			54	E	71		
5	A	94			55	A	45		
6	E	73			56	D	52		
7	C	74			57	B	59		
8	D	59			58	A	39		
9	E	78			59	C	60		
10	B	85			60	C	58		
11	C	83			61	E	73		
12	C	36			62	E	41		
13	A	59			63	D	47		
14	B	11			64	D	64		
15	E	59			65	C	66		
16	D	74			66	D	34		
17	A	70			67	D	26		
18	E	42			68	D	33		
19	A	53			69	D	51		
20	A	35			70	A	29		
21	C	57			71	B	65		
22	C	76			72	D	70		
23	B	16			73	D	11		
24	B	52			74	E	40		
25	E	83			75	B	19		
26	D	64			76	B	32		
27	C	30			77	C	39		
28	D	63			78	B	80		
29	C	47			79	D	49		
30	D	51			80	C	50		
31	C	73			81	B	60		
32	A	19			82	D	60		
33	E	72			83	E	48		
34	C	45			84	E	67		
35	B	30			85	B	56		
36	A	50			86	B	60		
37	E	53			87	D	74		
38	E	83			88	D	27		
39	C	53			89	D	49		
40	B	20			90	D	21		
41	B	58			91	C	60		
42	E	47			92	E	67		
43	D	39			93	B	21		
44	D	27			94	C	12		
45	C	15			95	D	51		
46	D	25			96	D	17		
47	D	32			97	E	20		
48	C	39			98	D	49		
49	D	49			99	E	40		
50	C	39			100	E	67		

Correct (C) _____

Incorrect (I) _____

Total Score:

C - I/4 = _____

Scaled Score (SS) = _____

* The P+ column indicates the percent of Physics Test examinees who answered each question correctly; it is based on a sample of November 2008 examinees selected to represent all Physics Test examinees tested between July 1, 2007 and June 30, 2010.

**Score Conversions and Percents Below*
for Physics Test, Form GR0877**

TOTAL SCORE					
Raw Score	Scaled Score	%	Raw Score	Scaled Score	%
82-100	990	95	45	690	53
81	980	94	44	680	50
80	970	93	42-43	670	48
79	960	92	41	660	46
78	950	91	39-40	650	44
77	940	90	38	640	42
76	930	90	36-37	630	39
75	920	89	35	620	37
73-74	910	87	33-34	610	34
72	900	86	32	600	32
71	890	85	30-31	590	29
70	880	84	29	580	27
69	870	83	28	570	25
68	860	82	26-27	560	22
66-67	850	80	25	550	21
65	840	79	23-24	540	18
64	830	77	22	530	16
63	820	76	20-21	520	13
61-62	810	74	19	510	12
60	800	73	17-18	500	10
59	790	72	16	490	8
57-58	780	70	15	480	7
56	770	68	13-14	470	5
55	760	66	12	460	4
53-54	750	64	10-11	450	3
52	740	62	9	440	2
51	730	61	7-8	430	2
49-50	720	59	6	420	1
48	710	57	5	410	1
46-47	700	55	3-4	400	1
			2	390	1
			0-1	380	1

*The percent scoring below the scaled score is based on the performance of 14,395 examinees who took the Physics Test between July 1, 2007 and June 30, 2010.

Evaluating Your Performance

Now that you have scored your test, you may wish to compare your performance with the performance of others who took this test. Both the worksheet on page 90 and the table on page 91 use performance data from GRE Physics Test examinees.

The data in the worksheet on page 90 are based on the performance of a sample of the examinees who took this test in November 2008. This sample was selected to represent the total population of GRE Physics Test examinees tested between July 2007 and June 2010. The numbers in the column labeled “P+” on the worksheet indicate the percentages of examinees in this sample who answered each question correctly. You may use these numbers as a guide for evaluating your performance on each test question.

The table on page 91 contains, for each scaled score, the percentage of examinees tested between July 2007 and June 2010 who received lower scores. Interpretive data based on the scores earned by examinees tested in this three-year period will be used by admissions officers in the 2011-12 testing year. These percentages appear in the score conversion table in a column to the right of the scaled scores. For example,

in the percentage column opposite the scaled score of 680 is the number 50. This means that 50 percent of the GRE Physics Test examinees tested between July 2007 and June 2010 scored lower than 680. To compare yourself with this population, look at the percentage next to the scaled score you earned on the practice test.

It is important to realize that the conditions under which you tested yourself were not exactly the same as those you will encounter at a test center. It is impossible to predict how different test-taking conditions will affect test performance, and this is only one factor that may account for differences between your practice test scores and your actual test scores. By comparing your performance on this practice test with the performance of other GRE Physics Test examinees, however, you will be able to determine your strengths and weaknesses and can then plan a program of study to prepare yourself for taking the GRE Physics Test under standard conditions.

SUBJECT TEST

COMPLETE THE
CERTIFICATION STATEMENT,
THEN TURN ANSWER SHEET
OVER TO SIDE 1.

CERTIFICATION STATEMENT

Please write the following statement below, DO NOT PRINT.
"I certify that I am the person whose name appears on this answer sheet. I also agree not to disclose the contents of the test I am taking today to anyone."
Sign and date where indicated.

SIGNATURE: _____ DATE: _____ / _____ / _____
Month Day Year

BE SURE EACH MARK IS DARK AND COMPLETELY FILLS THE INTENDED SPACE AS ILLUSTRATED HERE:
YOU MAY FIND MORE RESPONSE SPACES THAN YOU NEED. IF SO, PLEASE LEAVE THEM BLANK.

115	(A)	(B)	(C)	(D)	(E)	147	(A)	(B)	(C)	(D)	(E)	179	(A)	(B)	(C)	(D)	(E)	211	(A)	(B)	(C)	(D)	(E)
116	(A)	(B)	(C)	(D)	(E)	148	(A)	(B)	(C)	(D)	(E)	180	(A)	(B)	(C)	(D)	(E)	212	(A)	(B)	(C)	(D)	(E)
117	(A)	(B)	(C)	(D)	(E)	149	(A)	(B)	(C)	(D)	(E)	181	(A)	(B)	(C)	(D)	(E)	213	(A)	(B)	(C)	(D)	(E)
118	(A)	(B)	(C)	(D)	(E)	150	(A)	(B)	(C)	(D)	(E)	182	(A)	(B)	(C)	(D)	(E)	214	(A)	(B)	(C)	(D)	(E)
119	(A)	(B)	(C)	(D)	(E)	151	(A)	(B)	(C)	(D)	(E)	183	(A)	(B)	(C)	(D)	(E)	215	(A)	(B)	(C)	(D)	(E)
120	(A)	(B)	(C)	(D)	(E)	152	(A)	(B)	(C)	(D)	(E)	184	(A)	(B)	(C)	(D)	(E)	216	(A)	(B)	(C)	(D)	(E)
121	(A)	(B)	(C)	(D)	(E)	153	(A)	(B)	(C)	(D)	(E)	185	(A)	(B)	(C)	(D)	(E)	217	(A)	(B)	(C)	(D)	(E)
122	(A)	(B)	(C)	(D)	(E)	154	(A)	(B)	(C)	(D)	(E)	186	(A)	(B)	(C)	(D)	(E)	218	(A)	(B)	(C)	(D)	(E)
123	(A)	(B)	(C)	(D)	(E)	155	(A)	(B)	(C)	(D)	(E)	187	(A)	(B)	(C)	(D)	(E)	219	(A)	(B)	(C)	(D)	(E)
124	(A)	(B)	(C)	(D)	(E)	156	(A)	(B)	(C)	(D)	(E)	188	(A)	(B)	(C)	(D)	(E)	220	(A)	(B)	(C)	(D)	(E)
125	(A)	(B)	(C)	(D)	(E)	157	(A)	(B)	(C)	(D)	(E)	189	(A)	(B)	(C)	(D)	(E)	221	(A)	(B)	(C)	(D)	(E)
126	(A)	(B)	(C)	(D)	(E)	158	(A)	(B)	(C)	(D)	(E)	190	(A)	(B)	(C)	(D)	(E)	222	(A)	(B)	(C)	(D)	(E)
127	(A)	(B)	(C)	(D)	(E)	159	(A)	(B)	(C)	(D)	(E)	191	(A)	(B)	(C)	(D)	(E)	223	(A)	(B)	(C)	(D)	(E)
128	(A)	(B)	(C)	(D)	(E)	160	(A)	(B)	(C)	(D)	(E)	192	(A)	(B)	(C)	(D)	(E)	224	(A)	(B)	(C)	(D)	(E)
129	(A)	(B)	(C)	(D)	(E)	161	(A)	(B)	(C)	(D)	(E)	193	(A)	(B)	(C)	(D)	(E)	225	(A)	(B)	(C)	(D)	(E)
130	(A)	(B)	(C)	(D)	(E)	162	(A)	(B)	(C)	(D)	(E)	194	(A)	(B)	(C)	(D)	(E)	226	(A)	(B)	(C)	(D)	(E)
131	(A)	(B)	(C)	(D)	(E)	163	(A)	(B)	(C)	(D)	(E)	195	(A)	(B)	(C)	(D)	(E)	227	(A)	(B)	(C)	(D)	(E)
132	(A)	(B)	(C)	(D)	(E)	164	(A)	(B)	(C)	(D)	(E)	196	(A)	(B)	(C)	(D)	(E)	228	(A)	(B)	(C)	(D)	(E)
133	(A)	(B)	(C)	(D)	(E)	165	(A)	(B)	(C)	(D)	(E)	197	(A)	(B)	(C)	(D)	(E)	229	(A)	(B)	(C)	(D)	(E)
134	(A)	(B)	(C)	(D)	(E)	166	(A)	(B)	(C)	(D)	(E)	198	(A)	(B)	(C)	(D)	(E)	230	(A)	(B)	(C)	(D)	(E)
135	(A)	(B)	(C)	(D)	(E)	167	(A)	(B)	(C)	(D)	(E)	199	(A)	(B)	(C)	(D)	(E)	231	(A)	(B)	(C)	(D)	(E)
136	(A)	(B)	(C)	(D)	(E)	168	(A)	(B)	(C)	(D)	(E)	200	(A)	(B)	(C)	(D)	(E)	232	(A)	(B)	(C)	(D)	(E)
137	(A)	(B)	(C)	(D)	(E)	169	(A)	(B)	(C)	(D)	(E)	201	(A)	(B)	(C)	(D)	(E)	233	(A)	(B)	(C)	(D)	(E)
138	(A)	(B)	(C)	(D)	(E)	170	(A)	(B)	(C)	(D)	(E)	202	(A)	(B)	(C)	(D)	(E)	234	(A)	(B)	(C)	(D)	(E)
139	(A)	(B)	(C)	(D)	(E)	171	(A)	(B)	(C)	(D)	(E)	203	(A)	(B)	(C)	(D)	(E)	235	(A)	(B)	(C)	(D)	(E)
140	(A)	(B)	(C)	(D)	(E)	172	(A)	(B)	(C)	(D)	(E)	204	(A)	(B)	(C)	(D)	(E)	236	(A)	(B)	(C)	(D)	(E)
141	(A)	(B)	(C)	(D)	(E)	173	(A)	(B)	(C)	(D)	(E)	205	(A)	(B)	(C)	(D)	(E)	237	(A)	(B)	(C)	(D)	(E)
142	(A)	(B)	(C)	(D)	(E)	174	(A)	(B)	(C)	(D)	(E)	206	(A)	(B)	(C)	(D)	(E)	238	(A)	(B)	(C)	(D)	(E)
143	(A)	(B)	(C)	(D)	(E)	175	(A)	(B)	(C)	(D)	(E)	207	(A)	(B)	(C)	(D)	(E)	239	(A)	(B)	(C)	(D)	(E)
144	(A)	(B)	(C)	(D)	(E)	176	(A)	(B)	(C)	(D)	(E)	208	(A)	(B)	(C)	(D)	(E)	240	(A)	(B)	(C)	(D)	(E)
145	(A)	(B)	(C)	(D)	(E)	177	(A)	(B)	(C)	(D)	(E)	209	(A)	(B)	(C)	(D)	(E)	241	(A)	(B)	(C)	(D)	(E)
146	(A)	(B)	(C)	(D)	(E)	178	(A)	(B)	(C)	(D)	(E)	210	(A)	(B)	(C)	(D)	(E)	242	(A)	(B)	(C)	(D)	(E)

IF YOU DO NOT WANT THIS ANSWER SHEET TO BE SCORED

If you want to cancel your scores from this test administration, complete A and B below. You will not receive scores for this test. No record of this test or the cancellation will be sent to the recipients you indicated, and there will be no scores for this test on your GRE file.

To cancel your scores from this test administration, you must:

A. Fill in both ovals here . . . — B. sign your full name here: _____

TR	TW	TFS	TCS	1R	1W	1FS	1CS	2R	2W	2FS	2CS
FOR ETS USE ONLY				3R	3W	3FS	3CS	4R	4W	4FS	4CS
				5R	5W	5FS	5CS	6R	6W	6FS	6CS

88403-007627 • PDF711

761230



Listening. Learning. Leading.[®]

www.ets.org